



# LISTA DE PRECIOS

- MARZO 2026 -

**Weidmüller** 

# Weidmüller

## Conexel

**BIENVENIDO A CORESA - WEIDMÜLLER**

**Su socio en conectividad industrial inteligente en Argentina.**

Junto con nuestros clientes, damos forma a la transformación digital con productos, soluciones y servicios in IIOT, en todos los segmentos del mercado

### Automatización de maquinaria y plantas

 Bienes de consumo y envasado	 Automoción y proveedores
 Ascensores y escaleras mecánicas	 Intralógica

### Energía

 Eólica	 Fotovoltaica
 Energía Tradicional	 Transmisión y distribución

### Procesos

 Tratamiento de aguas	 Petróleo y gas
 Química y farmacéutica	 Hidrógeno

### Transporte

 Ferrocarril	 Marítimo
 Conceptos de movilidad	 Infraestructuras

### Infraestructura de edificios

 Edificios de oficinas	 Edificios industriales
 Edificios comerciales	 Edificios oficiales

### Fabricantes de dispositivos

 Robótica	 Dispositivos de control
 Dispositivos de telecomunicaciones	 Electrónica de potencia

# ÍNDICE

 *click en cada título  
para ir a cada sección*

## BORNES Pag.04

Bornes de paso a tornillo  
montaje Riel Din 35mm - línea Sak Pag.05

Bornes de paso cortocircuitable  
para instrumentación WLT 6/1 Pag.12

Bornes de paso cortocircuitable  
para instrumentación WLT 6/3 Pag.15

Bornes de paso cortocircuitable  
para inst. WTTB deslizable Pag.17

Borne Doble paso DK4 Pag.22

Bornes portafusible ASK1 y KDKS1  
(Fusible 20x5 mm) Pag.24

Bornes portafusible WSI 25 (10x38) y  
Borne de empalme aéreo reutilizable Pag.28

Borne de conexión ultra rápida Snap In  
(Libre de mantenimiento) Pag.29

Borne de paso Weidmüller a Push In  
(Libre de mantenimiento) Pag.31

Topes / Extremos de Bornero serie A Pag.35

Borne Portafusible Push In Pag.36

Elementos para señalización  
grupo de Bornes Pag.37

Riel Din Pag.39

Bornes de Potencia Pag.42

Bloques de distribución de  
potencia WPD Pag.43

## ELECTRÓNICA INDUSTRIAL Pag.44

Fuentes de Alimentación Pag.45

Relés Pag.49

Descargadores Pag.52

Descargadores Eco Pag.53

Adicionadores de señal Pag.54

## PRODUCTOS PARA EL INSTALADOR Pag.55

Carro de herramientas y Cortar Pag.56

Desaislar y Stripax Plus Pag.57

Crimpado Pag.58

Herramienta Hidráulica Sacabocado Pag.59

Destornilladores Pag.60

Destornilladores especiales y Pinzas Pag.61

llaves, Instrumentos y Valijas Pag.62

Impresora y accesorios Pag.63

Termocontraibles Pag.64

Identificadores Pag.65

Consumibles para el instalador  
electricista Pag.70

## CONECTORES CIRCULARES Y RECTANGULARES Pag.73

Capotas HDC Pag.74

Núcleos Pag.75

Bases Pag.76

Cables con conectores Pag.78

## ETHERNET INDUSTRIAL Pag.81

Switches Pag.82

Media Converters y Wifi Access points Pag.83

Accesorios Pag.84

## AUTOMATIZACIÓN INDUSTRIAL Pag.85

Controles y Sistemas de E/S Pag.86

Tarjetas de Entrada y Salida UC20-UR20 Pag.87

Energy Meters Pag.89

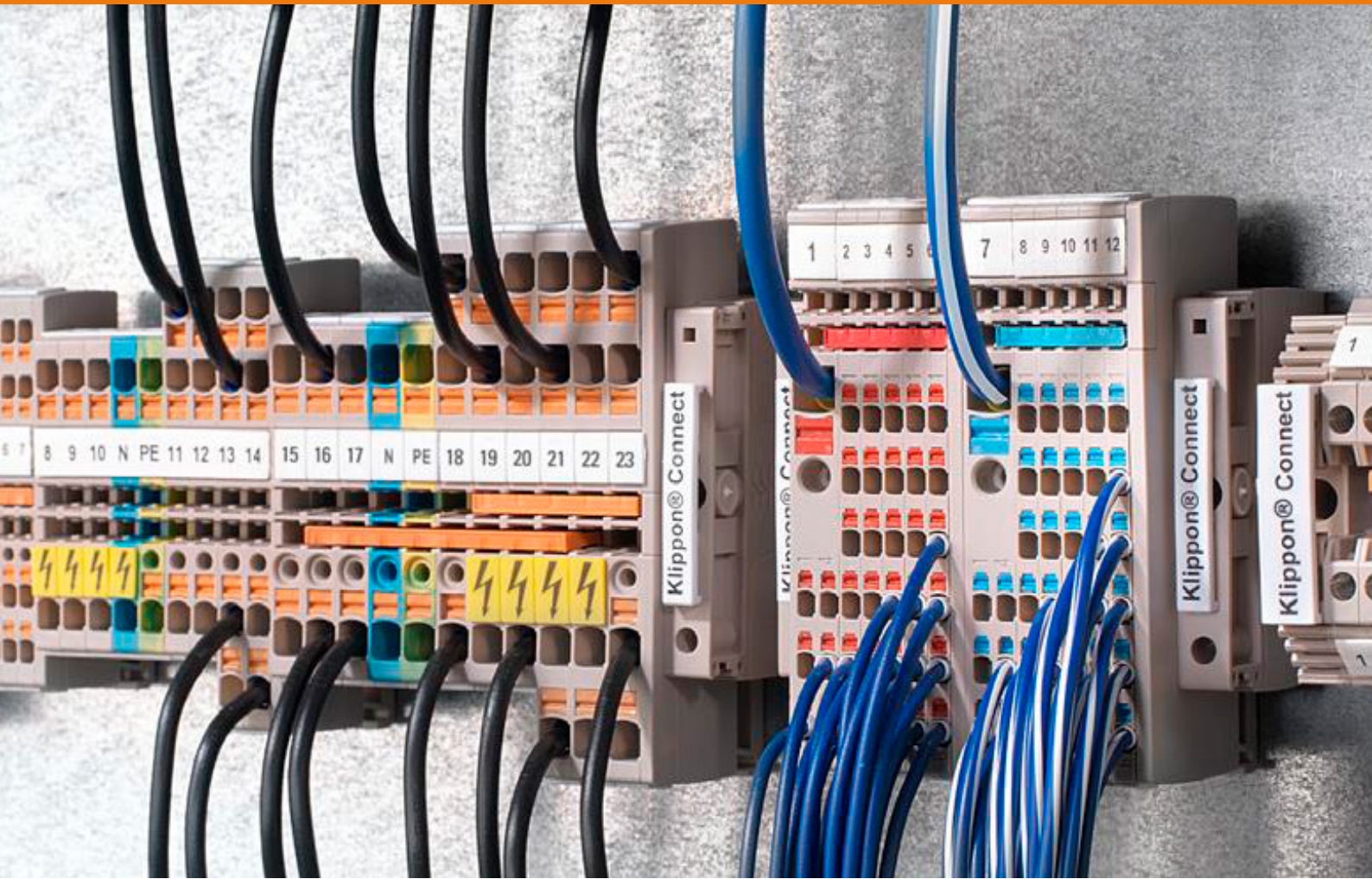

# BORNES

¿Buscas la técnica de conexión adecuada para tu cuadro eléctrico?

En combinación con nuestros bornes modulares, en Weidmüller te ofrecemos una amplia gama de tecnologías para conectar con seguridad hilos conductores y cables en el cuadro de distribución.

Puedes confiar en nuestras soluciones innovadoras, como la tecnología SNAP IN, que permite conectar cables flexibles directamente, incluso sin terminales. O confía en nuestra conexión por tornillo de eficacia probada en los bornes de tornillo. Cualquiera que sea tu necesidad, tenemos la solución adecuada para el carril estándar o placa de montaje.

¿Qué tecnología prefieres? ¿Conexión por tornillo? ¿Conexión PUSH IN? ¿Conexión SNAP IN?

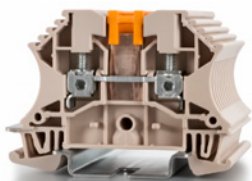

TORNILLO

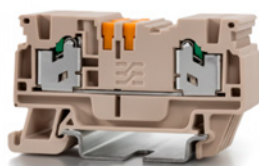

PUSH IN



SNAP IN

 [click para ir a la web de cada categoría](#)

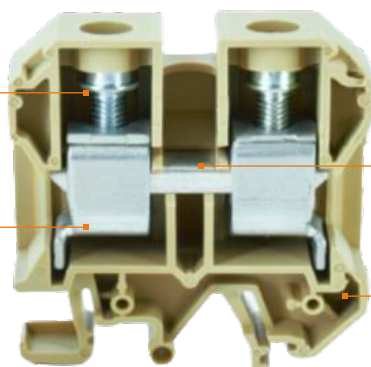

Tornillo Imperdible

Jaula en metales elásticos: Máxima tracción y resistencia mecánica para sostener el conductor.

Conductor no ferroso (Cobre), optimiza el paso de la corriente, resiste ambientes salinos/agresivos.

Poliamida 6,6 termoplástica. Material ignífugo de alta rigidez dieléctrica y amplio rango temperatura de trabajo, -50°C + 130°

✓ 100% de disponibilidad de cada borne por caja, cada uno testado en la fabrica.

✓ Confiando en nuestros tornillos imperdibles, los bornes se proveen abiertos desde origine, para ahorrar tiempo.

BORNES DE PASO SAK 2,5 MM<sup>2</sup> Y 4 MM<sup>2</sup>



Borne de paso

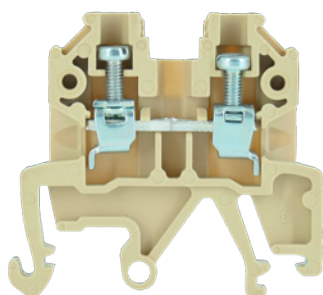

Borne de tierra

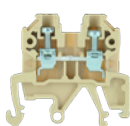
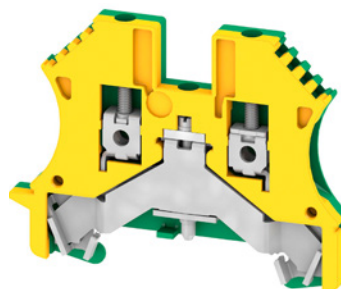

CÓD. FABRICANTE	SKU	DESCRIPCIÓN	MASTER	PRECIO
C027966.0100	SAK 2.5 Ex	BORNE DE PASO BEIGE SAK 2,5 mm <sup>2</sup> - 800V / 24A IEC/VDE - 0,5...2,5mm <sup>2</sup> (C027966.0100)	100u.	USD 0,68 IVA 21%
C012836.0100	SAK 4 Ex	BORNE DE PASO BEIGE SAK 4 mm <sup>2</sup> - 800V / 32A IEC/VDE - 0,5...4mm <sup>2</sup> (C012836.0100)	100u.	USD 0,84 IVA 21%
C902510.6100	SAK 2.5 BL Ex	BORNE DE PASO AZUL SAK 2,5 mm <sup>2</sup> - 800V / 24A IEC/VDE - 0,5...2,5mm <sup>2</sup> (C902510.6100)	100u.	USD 1,16 IVA 21%
C902513.6100	SAK 4 BL Ex	BORNE DE PASO AZUL SAK 4 mm <sup>2</sup> - 800V / 32A IEC/VDE - 0,5...4mm <sup>2</sup> (C902513.6100)	100u.	USD 1,23 IVA 21%
C906067.6000	SAK 2.5 PE	BORNE DE PASO Ver/Am SAK 2,5 mm <sup>2</sup> - 800V / 24A IEC/VDE - 0,5...2,5mm <sup>2</sup> (C906067.6000)	100u.	USD 1,16 IVA 21%
C906068.6000	SAK 4 PE	BORNE DE PASO Ver/Am SAK 4 mm <sup>2</sup> - 800V / 32A IEC/VDE - 0,5...4mm <sup>2</sup> (C906068.6000)	100u.	USD 1,56 IVA 21%
1010000000	WPE 2.5	BORNE DE TIERRA WPE 2.5 (1010000000)	100u.	USD 3,99 IVA 21%
1010100000	WPE 4	BORNE DE TIERRA WPE 4 (1010100000)	100u.	USD 4,25 IVA 21%

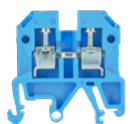

ACCESORIOS BORNES DE PASO SAK 2,5 MM<sup>2</sup> Y 4 MM<sup>2</sup>

Puentes Q





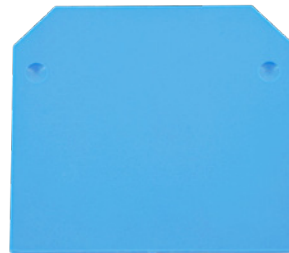



Tapas AP



Separadores TW

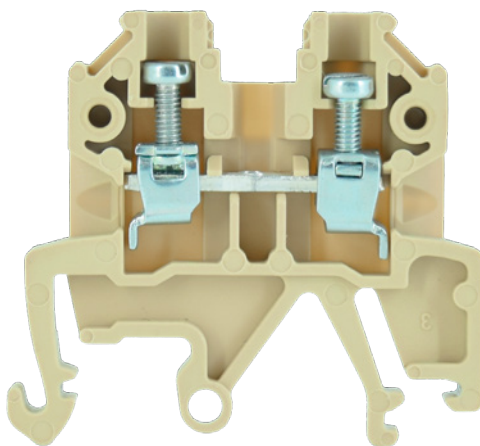

	CÓD. FABRICANTE	SKU	DESCRIPCIÓN	MASTER	PRECIO
	368700000	Q 10 SAK2.5	PUENTES Q 10 polos SAK 2,5 EN (368700000)	20u.	USD 6,20 IVA 21%
	368800000	Q 10 SAK4	PUENTES Q 10 polos SAK 4 EN (368800000)	20u.	USD 6,24 IVA 21%
	C027956.0100	AP SAK 2.5	TAPA AP SAK 2,5 BEIGE (C027956.0100)	20u.	USD 0,21 IVA 21%
	C011796.0100	AP SAK 4/10	TAPA AP SAK 4-10 BEIGE (C011796.0100)	20u.	USD 0,26 IVA 21%
	C027958.0100	AP SAK 2.5 BL	TAPA AP SAK 2,5 AZUL (C027958.0100)	20u.	USD 0,45 IVA 21%
	C011798.0100	AP SAK 4/10 BL	TAPA AP SAK 4-10 AZUL (C011798.0100)	20u.	USD 0,46 IVA 21%
	C902656.6100	AP SAK 2.5 GN	TAPA AP SAK 2,5 AZUL (C027958.0100)	20u.	USD 0,56 IVA 21%
	C902654.6100	AP SAK 4/10 GN	TAPA AP SAK 4-10 VERDE (C902654.6100)	20u.	USD 0,54 IVA 21%
	C030286.0000	TW SAK 2.5	SEPARADOR TW SAK 2.5 BEIGE (C030286.0000)	20u.	USD 0,32 IVA 21%
	C013016.0000	TW SAK 4/10	SEPARADOR TW 4 SAK4-10 BEIGE (C013016.0000)	20u.	USD 0,33 IVA 21%
	C030288.0000	TW SAK 2.5 BL	SEPARADOR TW SAK 2.5 BL AZUL (C030288.0000)	20u.	USD 0,78 IVA 21%
	C013018.0000	TW SAK 4/10 BL	SEPARADOR TW 4 SAK4-10 AZUL (C013018.0000)	20u.	USD 0,64 IVA 21%

BORNE PARA TERMOCUPLAS 2,5 MM<sup>2</sup>

CÓD. FABRICANTE	SKU	DESCRIPCIÓN	MASTER	PRECIO
C010726.010A	SAK 2.5 TC-CH K	SAK 2.5 TC EN-CH K positivo CROMO - NIQUEL (C010726.010A)	100u.	USD 4,96 IVA 21%
C010716.010A	SAK 2.5 TC-AL K	SAK 2.5 TC EN-AL K negativo ALUMINIO (C010716.010A)	100u.	USD 4,96 IVA 21%
C019006.010A	SAK 2.5 TC-FE J	SAK 2.5 TC EN-FE J positivo HIERRO (C019006.010A)	100u.	USD 3,62 IVA 21%
C018986.010A	SAK 2.5 TC-CO T/J	SAK 2.5 TC EN-CO T/J negativo COBRE - NIQUEL (C018986.010A)	100u.	USD 3,22 IVA 21%

BORNES DE PASO SAK 6 MM<sup>2</sup>, 10 MM<sup>2</sup> Y 16 MM<sup>2</sup>



Borne de paso

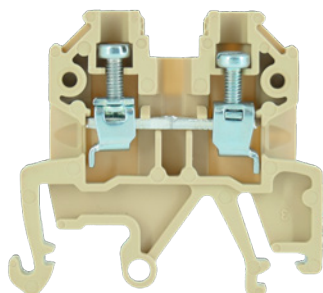

Borne de tierra

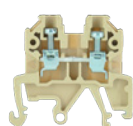
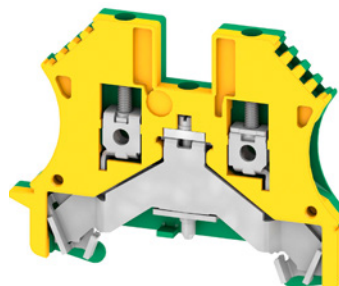

CÓD. FABRICANTE	SKU	DESCRIPCIÓN	MASTER	PRECIO
C019326.0100	SAK 6 Ex	BORNE DE PASO BEIGE SAK 6 mm <sup>2</sup> 800V / 41A IEC/VDE 0,5...6mm <sup>2</sup> (C019326.0100)	100u.	USD 4,04 IVA 21%
C011006.0100	SAK 10 Ex	BORNE DE PASO BEIGE SAK 10 mm <sup>2</sup> 800V / 57A IEC/VDE 0,5...6mm <sup>2</sup> (C011006.0100)	100u.	USD 1,53 IVA 21%
C027106.0100	SAK 16 Ex	BORNE DE PASO BEIGE SAK 16 mm <sup>2</sup> 1000V / 76A IEC/VDE 4,0...16mm <sup>2</sup> (C027106.0100)	50u.	USD 2,68 IVA 21%



C902516.6100	SAK 6 BL Ex	BORNE DE PASO AZUL SAK 6 mm <sup>2</sup> 800V / 41A IEC/VDE 0,5...6mm <sup>2</sup> (C902516.6100)	100u.	USD 1,53 IVA 21%
C011008.0100	SAK 10 BL Ex	BORNE DE PASO AZUL SAK 10 mm <sup>2</sup> 800V / 57A IEC/VDE 0,5...6mm <sup>2</sup> (C011008.0100)	100u.	USD 2,34 IVA 21%
C906071.6000	SAK 16 BL Ex	BORNE DE PASO AZUL SAK 16 mm <sup>2</sup> 1000V / 76A IEC/VDE 4,0...16mm <sup>2</sup> (C027108.0100)	50u.	USD 2,68 IVA 21%



C906069.6000	SAK 6 PE	BORNE DE PASO Ver/Am SAK 6 mm <sup>2</sup> 800V / 41A IEC/VDE 0,5...6mm <sup>2</sup> (C906069.6000)	100u.	USD 2,22 IVA 21%
C906070.6000	SAK 10 PE	BORNE DE PASO Ver/Am SAK 10 mm <sup>2</sup> 800V / 57A IEC/VDE 0,5...6mm <sup>2</sup> (C906070.6000)	100u.	USD 2,69 IVA 21%
C906071.6000	SAK 16 PE	BORNE DE PASO Ver/Am SAK 16 mm <sup>2</sup> 1000V / 76A IEC/VDE 4,0...16mm <sup>2</sup> (C906071.6000)	50u.	USD 4,04 IVA 21%



1010200000	WPE 6	BORNE DE TIERRA WPE 6 (1010200000)	50u.	USD 4,96 IVA 21%
1010300000	WPE 10	BORNE DE TIERRA WPE 10 (1010300000)	50u.	USD 7,81 IVA 21%
1010400000	WPE 16	BORNE DE TIERRA WPE 16 (1010400000)	50u.	USD 9,49 IVA 21%

ACCESORIOS BORNES DE PASO SAK 6 MM<sup>2</sup>, 10 MM<sup>2</sup> Y 16 MM<sup>2</sup>

Puentes Q



Tapas AP

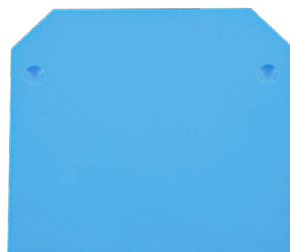

Separadores TW



CÓD. FABRICANTE	SKU	DESCRIPCIÓN	MASTER	PRECIO
457000000	Q 10 SAK6N	PUNTES Q 10 polos SAK 6 EN (457000000)	20u.	USD 7,9 IVA 21%
457300000	Q 4 SAK10	PUNTES Q 4 polos SAK 10 EN (457300000)	50u.	USD 6,69 IVA 21%
457700000	Q 4 SAK16	PUNTES Q 4 polos SAK 16 (457700000)	50u.	USD 6,69 IVA 21%



C011796.0100	AP SAK 4/10	TAPA AP SAK 4-10 BEIGE (C011796.0100)	20u.	USD 0,26 IVA 21%
C027116.0100	AP SAK 16	TAPA AP SAK 16 BEIGE (C027116.0100)	20u.	USD 0,38 IVA 21%



C011798.0100	AP SAK 4/10 BL	TAPA AP SAK 4-10 AZUL (C011798.0100)	20u.	USD 0,46 IVA 21%
C027118.0100	AP SAK 16 BL	TAPA AP SAK 16 AZUL (C027118.0100)	20u.	USD 0,46 IVA 21%



C902654.6100	AP SAK 4/10 GN	TAPA AP SAK 4-10 VERDE (C902654.6100)	20u.	USD 0,54 IVA 21%
--------------	----------------	---------------------------------------	------	---------------------



C013016.0000	TW SAK 4/10	SEPARADOR TW 4 SAK4-10 BEIGE (C013016.0000)	20u.	USD 0,33 IVA 21%
C030366.0100	TW SAK 16/35	SEPARADOR TW SAK 16 BEIGE (C030366.0100)	20u.	USD 0,52 IVA 21%



C013018.0000	TW SAK 4/10 BL	SEPARADOR TW 4 SAK4-10 AZUL (C013018.0000)	20u.	USD 0,64 IVA 21%
C030368.0100	TW SAK 16/35 BL	SEPARADOR TW SAK 16 AZUL (C030368.0100)	20u.	USD 1,41 IVA 21%

BORNES DE PASO SAK 35 MM<sup>2</sup>

Borne de paso

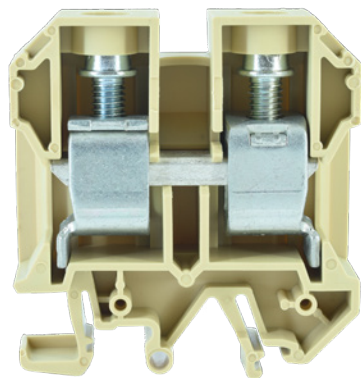

Borne de tierra

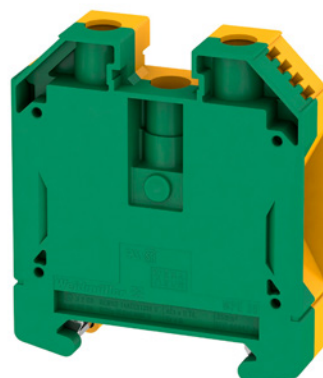

CÓD. FABRICANTE	SKU	DESCRIPCIÓN	MASTER	PRECIO
C030356.010A	SAK 35	BORNE DE PASO BEIGE SAK 35 mm <sup>2</sup> 800V / 125A IEC/VDE 6,0...35mm <sup>2</sup> (C030356.010A)	20u.	USD 6,32 IVA 21%



C030358.010A	SAK 35 BL	BORNE DE PASO AZUL SAK 35 mm <sup>2</sup> 800V / 125A IEC/VDE 6,0...35mm <sup>2</sup> (C030358.010A)	20u.	USD 6,75 IVA 21%
--------------	-----------	--	------	---------------------



C906072.600A	SAK 35 PE	BORNE DE PASO Ver/Am SAK 35 mm <sup>2</sup> 800V / 125A IEC/VDE 6,0...35mm <sup>2</sup> (C906072.600A)	20u.	USD 8,71 IVA 21%
--------------	-----------	--	------	---------------------



1010500000	WPE 35	BORNE DE TIERRA WPE 35 (1010500000)	25u.	USD 15,98 IVA 21%
------------	--------	-------------------------------------	------	----------------------

ACCESORIOS BORNES DE PASO SAK 35 MM<sup>2</sup>

Puentes Q



Separadores TW



CÓD. FABRICANTE	SKU	DESCRIPCIÓN	MASTER	PRECIO
C012381.0000	SAK 35 ST25 Q4	PUENTE SAK35 Q 4 polos (C012381.0000)	50u.	USD 5,44 IVA 21%



C030366.0100	TW SAK 16/35	SEPARADOR TW SAK 16 BEIGE (C030366.0100)	20u.	USD 0,52 IVA 21%
C030436.0100	TW SAK 35	SEPARADOR TW SAK 35 BEIGE (C030436.0100)	20u.	USD 0,58 IVA 21%



C030368.0100	TW SAK 16/35 BL	SEPARADOR TW SAK 16 AZUL (C030368.0100)	20u.	USD 1,41 IVA 21%
C030438.0100	TW SAK 35 BL	SEPARADOR TW SAK 35 AZUL (C030438.0100)	20u.	USD 0,58 IVA 21%

## SEPARADORES - ESPESOR 1,5 MM



CÓD. FABRICANTE	SKU	DESCRIPCIÓN	MASTER	PRECIO
C030286.0000	TW SAK 2.5	SEPARADOR TW SAK 2.5 BEIGE (C030286.0000)	20u.	USD 0,32 IVA 21%
C013016.0000	TW SAK 4/10	SEPARADOR TW 4 SAK4-10 BEIGE (C013016.0000)	20u.	USD 0,33 IVA 21%
C030366.0100	TW SAK 16/35	SEPARADOR TW SAK 16 BEIGE (C030366.0100)	20u.	USD 0,52 IVA 21%
C030436.0100	TW SAK 35	SEPARADOR TW SAK 35 BEIGE (C030436.0100)	20u.	USD 0,58 IVA 21%



C030288.0000	TW SAK 2.5 BL	SEPARADOR TW SAK 2.5 BL AZUL (C030288.0000)	20u.	USD 0,78 IVA 21%
C013018.0000	TW SAK 4/10 BL	SEPARADOR TW 4 SAK4-10 AZUL (C013018.0000)	20u.	USD 0,64 IVA 21%
C030368.0100	TW SAK 16/35 BL	SEPARADOR TW SAK 16 AZUL (C030368.0100)	20u.	USD 1,41 IVA 21%

# BORNE DE PASO CORTOCIRCUITABLE PARA INSTRUMENTACIÓN WTL 6/1

7. STB 36.8/IH/BL WTL6/1

14. STB 21.6/45 SW

6. STB 36.8/IH/VI WTL6/1

5. STB 36.8/IH/GN WTL6/1

4. STB 36.8/IH/GE WTL6/1

8. BS 25 GE

3. WTL 6/1 EN

1. WEW35/2/EWK1

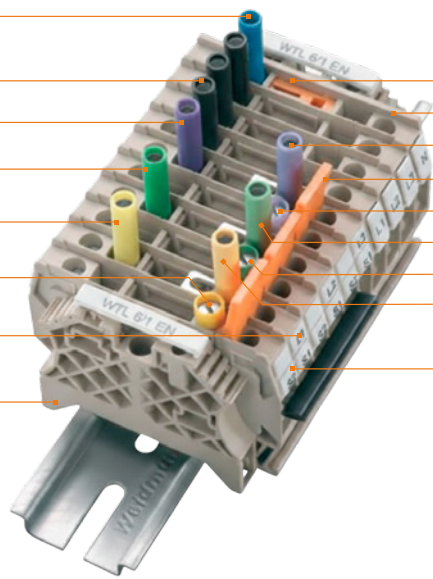

15. SSP 3

19. WAP WTL

13. STB 21.6/45 VI

16. WKS 2/2

10. BS 25 VI

12. STB 21.6/45 GN

9. BS 25 GN

11. STB 21.6/45 GE

2. WTD 6/1 EN

### ORDERING DATA

POS.	TYPE	ORDER No.	Qty.
1	WEW35/2/EWK1	1061200000	2
2	WTD 6/1 EN	1934830000	3
3	WTL 6/1 EN	1934810000	7
4	STB 36.8/IH/GE WTL6/1	1847760000	1
5	STB 36.8/IH/GN WTL6/1	1847770000	1
6	STB 36.8/IH/VI WTL6/1	1847780000	1
7	STB 36.8/IH/BL WTL6/1	1847790000	1
8	BS 25 GE	0335700000	1
9	BS 25 GN	0335600000	1
10	BS 25 VI	0335600000	1
11	STB 21.6/45 GE	1936240000	2
12	STB 21.6/45 GN	1936250000	2
13	STB 21.6/45 VI	1936260000	2
14	STB 21.6/45 SW	1936270000	2
15	SSP 3	0531760000	7
16	WKS 2/2	1936140000	3
17	QB 58/8/9/WI	0545300000	1
18	ISPF QB58 SW	0546000000	1
19	WAP WTL	1957710000	1
20	VH16	0309700000	9

## BORNES SECCIONABLES

Para WTL 6/1/STB

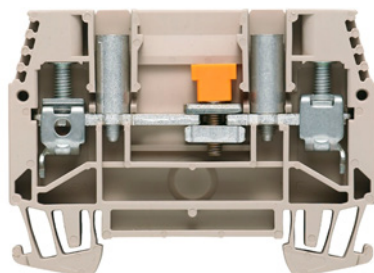

Para WTL 6/1/STB con receptáculo Banana

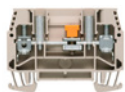

CÓD. FABRICANTE	SKU	DESCRIPCIÓN	MASTER	PRECIO
1016900000	WTL 6/1/STB	BORNE SECCIONABLE para instrumentos WTL 6/1/STB (1016900000)	50u.	USD 7,17 IVA 10.5%



1019690000	WTL 6/1 STB GR	BORNE SECCIONABLE para instrumentos WTL 6/1 EN STB c/receptaculo banana GR (GRIS claro) (1019690000)	50u.	USD 7,18 IVA 10.5%
------------	----------------	--	------	-----------------------



1019710000	WTL 6/1 STB RT	BORNE SECCIONABLE para instrumentos WTL 6/1 EN STB c/receptaculo banana RT (ROJO) (1019710000)	50u.	USD 14,06 IVA 10.5%
------------	----------------	--	------	------------------------



1062520000	WTL 6/1 STB SW	WTL 6/1 EN STB c/receptaculo banana SW (NEGRO) (1062520000)	50u.	USD 11,54 IVA 10.5%
------------	----------------	---	------	------------------------

## ACCESORIOS PARA WTL 6/1

### BS/VH



### WQV/QL



WQV  
(for WTL 6/2,6/3)

### WKB/WKS



WKB



WKS 1



WKS 2

### QS 2



## CONEXIÓN TRANSVERSAL ATORNILLABLE



CÓD. FABRICANTE	SKU	DESCRIPCIÓN	MASTER	PRECIO
1052360000	WQV 6/2	PUENTE WQV 6/2 (1052360000)	50u.	USD 0,95 IVA 21%



1054760000	WQV 6/3	PUENTE WQV 6/3 (1054760000)	50u.	USD 4,24 IVA 21%
------------	---------	-----------------------------	------	---------------------



1054860000	WQV 6/4	PUENTE WQV 6/4 (1054860000)	50u.	USD 5,51 IVA 21%
------------	---------	-----------------------------	------	---------------------



1052260000	WQV 6/10	PUENTE WQV 6/10 (1052260000)	20u.	USD 4,05 IVA 21%
------------	----------	------------------------------	------	---------------------

## PLACA FINAL / PLACA DIVISORIA



CÓD. FABRICANTE	SKU	DESCRIPCIÓN	MASTER	PRECIO
1957710000	WAP WTL6/1	PUENTE WQV 6/2 (1052360000)	20u.	USD 1,84 IVA 21%



1068400000	WTW WTL6/1 DB	SEPARADOR DE BORNES WTW WTL6/1 DB (1068400000)	20u.	USD 2,54 IVA 21%
------------	---------------	--	------	---------------------

## ACCESORIOS PARA WTL 6/1

### CONTROL DESLIZANTE DE CONEXIÓN CRUZADA



CÓD. FABRICANTE	SKU	DESCRIPCIÓN	MASTER	PRECIO
1936140000	WKS 2/2	CORREDERA DE CONEXIÓN TRANSVERSAL,WKS 2/2 (1936140000)	50u.	USD 5,88 IVA 21%



1936150000	WKS 2/3	CORREDERA DE CONEXIÓN TRANSVERSAL,WKS 2/3 (1936150000)	50u.	USD 8,64 IVA 21%
------------	---------	--	------	---------------------



1936160000	WKS 2/4	CORREDERA DE CONEXIÓN TRANSVERSAL,WKS 2/4 (1936160000)	50u.	USD 11,60 IVA 21%
------------	---------	--	------	----------------------



309700000	VH 16/5/3.5 SAK10-35	ACCESORIO BORNES VH 16/5/3.5 SAK10-35 (309700000)	50u.	USD 1,44 IVA 21%
-----------	----------------------	---	------	---------------------

### PRUEBAS / COMPROBACIÓN



CÓD. FABRICANTE	SKU	DESCRIPCIÓN	MASTER	PRECIO
1936290000	STB 21.6/45 BL	CLAVIJA - STB 21.6/45 BL (1936290000)	50u.	USD 2,41 IVA 21%

1936240000	STB 21.6/45 GE	CLAVIJA - STB 21.6/45 GE (1936240000)	50u.	USD 2,41 IVA 21%
------------	----------------	---------------------------------------	------	---------------------

1936250000	STB 21.6/45 GN	CLAVIJA - STB 21.6/45 GN (1936250000)	50u.	USD 2,41 IVA 21%
------------	----------------	---------------------------------------	------	---------------------

1847760000	STB 36.8/IH/GE WTL6/1	CONECTOR HEMBRA AMARILLO para borne STB 36.8/IH/GE WTL6/1 (1847760000)	50u.	USD 5,97 IVA 21%
------------	-----------------------	--	------	---------------------

1847770000	STB 36.8/IH/GN WTL6/1	CONECTOR HEMBRA VERDE para borne STB 36.8/IH/GN WTL6/1 (1847770000)	50u.	USD 5,97 IVA 21%
------------	-----------------------	---	------	---------------------

# BORNE DE PASO CORTOCIRCUITABLE PARA INSTRUMENTACIÓN WTL 6/3

## BORNES SECCIONABLES

Para WTL 6/3  
SIN receptáculo  
F/Banana



Para WTL 6/3  
CON receptáculo  
F/Banana

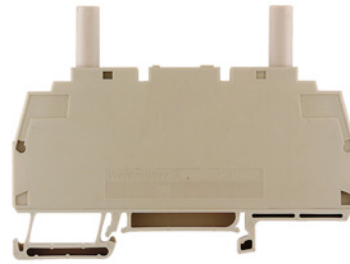

CÓD. FABRICANTE	SKU	DESCRIPCIÓN	MASTER	PRECIO
1018800000	WTL 6/3	BORNE SECCIONABLE para instrumentos sin receptaculo f/banana WTL 6/3 (1018800000)	50u.	USD 7,19 IVA 10.5%



1018600000	WTL 6/3/STB	BORNE SECCIONABLE para instrumentos con receptaculo f/banana WTL 6/3/STB (1018600000)	50u.	USD 7,78 IVA 10.5%
------------	-------------	---	------	-----------------------

## ACCESORIOS PARA WTL 6/3



CÓD. FABRICANTE	SKU	DESCRIPCIÓN	MASTER	PRECIO
1604200000	SSP WTL6/2	SSP WTL6/2 (bloqueo para WTL6/3) (1604200000)	100u.	USD 1,55 IVA 21%

## JUMPERS ATORNILLABLES



CÓD. FABRICANTE	SKU	DESCRIPCIÓN	MASTER	PRECIO
1052360000	WQV 6/2	PUENTE WQV 6/2 (1052360000)	50u.	USD 0,95 IVA 21%



1054760000	WQV 6/3	PUENTE WQV 6/3 (1054760000)	50u.	USD 4,24 IVA 21%
------------	---------	-----------------------------	------	---------------------



1054860000	WQV 6/4	PUENTE WQV 6/4 (1054860000)	50u.	USD 5,51 IVA 21%
------------	---------	-----------------------------	------	---------------------



1052260000	WQV 6/10	PUENTE WQV 6/10 (1052260000)	20u.	USD 4,05 IVA 21%
------------	----------	------------------------------	------	---------------------

## JUMPERS DESLIZABLES



CÓD. FABRICANTE	SKU	DESCRIPCIÓN	MASTER	PRECIO
1604270000	WKS 1/2	WKS 1/2 jumper deslizables 2 polos (1604270000)	50u.	USD 2,94 IVA 21%



1604290000	WKS 1/3	WKS 1/3 jumper deslizables 3 polos (1604290000)	50u.	USD 13,78 IVA 21%
------------	---------	---	------	----------------------



1604310000	WKS 1/4	WKS 1/4 jumper deslizables 4 polos (1604310000)	50u.	USD 14,62 IVA 21%
------------	---------	---	------	----------------------



299600000	PS 4 F.STB 4	PS 4 F.STB 4 ficha banana (299600000)	20u.	USD 9,66 IVA 21%
-----------	--------------	---------------------------------------	------	---------------------

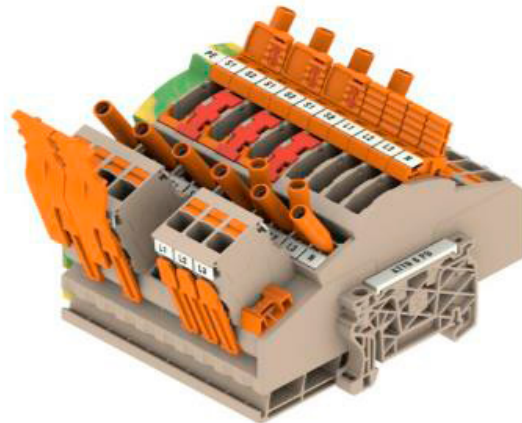

## BORNES SECCIONABLES

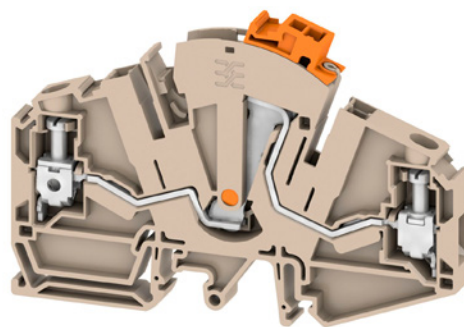

WTTB6



	CÓD. FABRICANTE	SKU	DESCRIPCIÓN	MASTER	PRECIO
	2710090000	WTTB 6	BORNE SECCIONABLE del transformador de medición, Conexión brida-tornillo, 500, 30, 2 WTTB 6 (2710090000)	50u.	USD 13,78 <small>IVA 10,5%</small>
	2985580000	WTTB 6 BR	BORNE SECCIONABLE del transformador de medición, PUSH IN, 500, 30, 2 WTTB 6 BR (2985580000)	50u.	USD 16,41 <small>IVA 10,5%</small>
	2926550000	WTTB 6 RD	BORNE SECCIONABLE del transformador de medición, Conexión brida-tornillo, 500, 30, 2 WTTB 6 RD (2926550000)	50u.	USD 16,41 <small>IVA 10,5%</small>
	2740060000	WTTB 6 BK	BORNE SECCIONABLE del transformador de medición, Conexión brida-tornillo, 500, 30, 2 WTTB 6 BK (2740060000)	50u.	USD 15,35 <small>IVA 10,5%</small>
	2740040000	WTTB 6 BL	BORNE SECCIONABLE del transformador de medición, Conexión brida-tornillo, 30, 2 WTTB 6 BL (2740040000)	50u.	USD 15,35 <small>IVA 10,5%</small>
	2710100000	WTTB 6 PE	BORNE DE TIERRA, Conexión brida-tornillo, VERDE/AMARILLO, 6 mm <sup>2</sup> , 500 V, Número de conexiones: 2, Número de pisos: 1 WTTB 6 PE (2710100000)	50u.	USD 16,37 <small>IVA 10,5%</small>

## ACCESORIOS BORNE DE PASO PARA INST. WTTB

### PUENTE DE CORTOCIRCUITO



CÓD. FABRICANTE	SKU	DESCRIPCIÓN	MASTER	PRECIO
2710190000	SCCB TTB 6/2	CONEXIÓN TRANSVERSAL (BORNE), insertado, NARANJA, 30 A, Número de polos: 2, SCCB TTB 6/2 (2710190000)	25u.	USD 2,41 IVA 21%



2710200000	SCCB TTB 6/3	CONEXIÓN TRANSVERSAL (BORNE), insertado, NARANJA, 30 A, Número de polos: 3, SCCB TTB 6/3 (2710200000)	25u.	USD 4,25 IVA 21%
------------	--------------	---	------	---------------------



2710210000	SCCB TTB 6/4	CONEXIÓN TRANSVERSAL (BORNE), insertado, NARANJA, 30 A, Número de polos: 4, SCCB TTB 6/4 (2710210000)	25u.	USD 5,85 IVA 21%
------------	--------------	---	------	---------------------

### ACCESORIOS WTTB CONECTOR CRUZADO



CÓD. FABRICANTE	SKU	DESCRIPCIÓN	MASTER	PRECIO
2733950000	ZQV 6N/6	PUENTE NARANJA, 41 A, Número de polos: 6, Paso en mm (P): 8.00, Aislado: Sí, ZQV 6N/6 (2733950000)	20u.	USD 5,92 IVA 21%



2733960000	ZQV 6N/7	PUENTE NARANJA, 41 A, Número de polos: 7, Paso en mm (P): 8.00, Aislado: Sí, ZQV 6N/7 (2733960000)	20u.	USD 8,82 IVA 21%
------------	----------	--	------	---------------------



2733970000	ZQV 6N/10	PUENTE NARANJA, 41 A, Número de polos: 10, Paso en mm (P): 8.00, Aislado: Sí, ZQV 6N/10 (2733970000)	20u.	USD 12,04 IVA 21%
------------	-----------	--	------	----------------------

## PLACA FINAL / PLACA DIVISORIA



CÓD. FABRICANTE	SKU	DESCRIPCIÓN	MASTER	PRECIO
2710170000	EP TTB 6	TAPA EP TTB 6 (2710170000)	20u.	USD 1,38 IVA 21%

## ENLACE DE PALANCA



CÓD. FABRICANTE	SKU	DESCRIPCIÓN	MASTER	PRECIO
2710230000	LL TTB 6/1	Palanca antiencastre (borne) LL TTB 6/1 (2710230000)	50u.	USD 0,19 IVA 21%



2710300000	LL TTB 6/2	Palanca antiencastre (borne) LL TTB 6/2 (2710300000)	50u.	USD 0,27 IVA 21%
------------	------------	--	------	---------------------



2710370000	LL TTB 6/2 CM	Palanca antiencastre (borne) LL TTB 6/2 CM (2710370000)	50u.	USD 1,55 IVA 21%
------------	---------------	---	------	---------------------

## PRUEBAS / COMPROBACIÓN



CÓD. FABRICANTE	SKU	DESCRIPCIÓN	MASTER	PRECIO
2710470000	TS TTB 6 OR	CONECTOR HEMBRA banana (borne)TS TTB 6 OR (2710470000)	48u.	USD 2,59 IVA 21%

## TRABA / BLOQUEO



CÓD. FABRICANTE	SKU	DESCRIPCIÓN	MASTER	PRECIO
2710220000	SL TTB 6	Sistema de bloqueo de la conexión (borne), PA 66/6, ROJO SL TTB 6 (2710220000)	50u.	USD 0,18 IVA 21%

CUBIERTA CUBRE BORNES WTTB

Carcasa protectora



Ángulo de fijación lateral

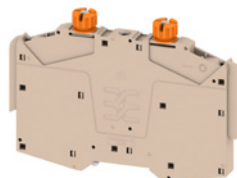

	CÓD. FABRICANTE	SKU	DESCRIPCIÓN	MASTER	PRECIO
	2710130000	CH TTB	CARCASA PROTECTORA (borne) CH TTB (2710130000)	1u.	USD 73,89 IVA 21%
	2710140000	CP TTB	CARCASA PROTECTORA (borne) CP TTB (2710140000)	10u.	USD 148,53 IVA 21%
	2710150000	CS TTB	SERIE A, Ángulo de fijación lateral CS TTB (2710150000)	10u.	USD 14,46 IVA 21%

TOPES / EXTREMOS DE BORNERA

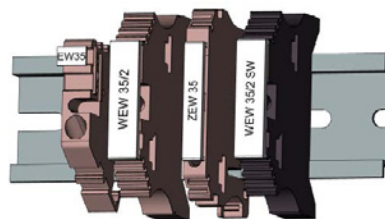
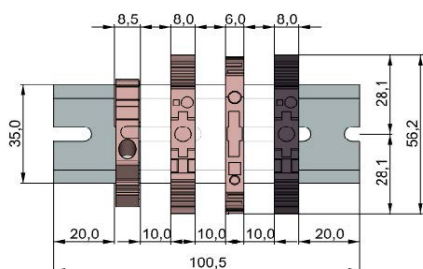

	CÓD. FABRICANTE	SKU	DESCRIPCIÓN	MASTER	PRECIO
	C038356.0000	EW35	TOPE FINAL EW35 BEIGE (C038356.0000)	50u.	USD 1,00 IVA 21%
	1061200000	WEW 35/2	EXTREMO DE BORNERA WEW 35/2 BEIGE (1061200000)	50u.	USD 1,41 IVA 21%
	9540000000	ZEW 35	TOPE sin tornillos ZEW 35 BEIGE (9540000000)	20u.	USD 0,94 IVA 21%
	1061210000	WEW 35/2 SW	EXTREMO DE BORNERA WEW 35/2 NEGRO (1061210000)	50u.	USD 1,52 IVA 21%

## COMPLEMENTOS DE TOPES / EXTREMOS DE BORNERA

Accesorio para tope final



Etiqueta para impresora



Rótulos 5/5 - 5/6



CÓD. FABRICANTE	SKU	DESCRIPCIÓN	MASTER	PRECIO
1806120000	EM 8/30	EM 8/30 Accesorio para tope final WEW 35/2 (1806120000)	50u.	USD 0,98 IVA 21%
2009980000	ELS 6/30 MM WS	ELS 6/30 Etiqueta para Impresora THM (2009980000)	3000u.	USD 0,39 IVA 21%
2007110000	DEK 5/5 MM WS	ROTULO P-BORNES Weidmuller DEK 5/5 MM WS 800 u. (1 rollo) (2007110000)	800u.	USD 0,16 IVA 21%
2007120000	DEK 5/6 MM WS	ROTULO P-BORNES Weidmuller DEK 5/6 MM WS insercion continua SAK 2,5 600 u. (1 rollo) (2007120000)	600u.	USD 0,08 IVA 21%

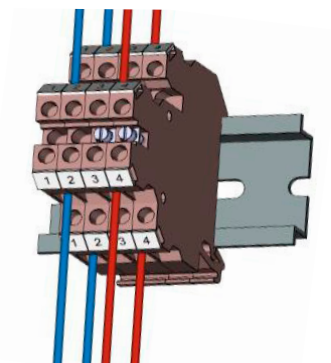

## PASO SUPERIOR E INFERIOR INDEPENDIENTES

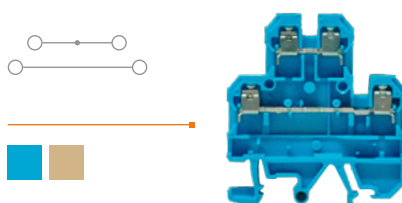

CÓD. FABRICANTE	SKU	DESCRIPCIÓN	MASTER	PRECIO
C059006.0100	DK4Q	BORNE DOBLE DK4Q Beige - paso superior e inferior independientes	100u.	USD 0,66 IVA 21%



C903094.6100	DK4Q BL	BORNE DOBLE DK4Q AZUL - paso superior e inferior independientes (C903094.610A)	100u.	USD 4,80 IVA 21%
--------------	---------	--	-------	---------------------

## PASO SUPERIOR E INFERIOR INTERCONECTADOS

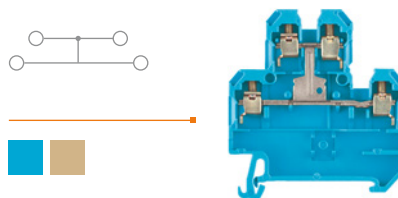

CÓD. FABRICANTE	SKU	DESCRIPCIÓN	MASTER	PRECIO
C059006.0100	DK4QV	BORNE DOBLE DK4QV BEIGE - paso superior e inferior interconectados (C059026.010A)	100u.	USD 3,35 IVA 21%

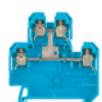

C903094.6100	DK4QV BL	BORNE DOBLE DK4QV AZUL - paso superior e inferior interconectados (C059028.010A)	100u.	USD 3,80 IVA 21%
--------------	----------	--	-------	---------------------

## ACCESORIOS BORNE DOBLE PASO DK4Q

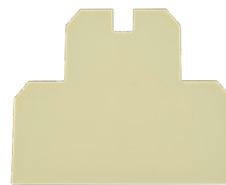
Puente Q10  
10 PolosTapa  
DK4Q

CÓD. FABRICANTE	SKU	DESCRIPCIÓN	MASTER	PRECIO
368600000	Q 10 AKZ4	PUENTE Q10 AKZ4 10 polos (368600000)	20u.	USD 4,69 IVA 21%
C139716.0000	AP DK4Q	TAPA DK4Q BEIGE (C139716.0000)	20u.	USD 0,66 IVA 21%
C139718.0000	AP DK4Q BL	TAPA DK4Q AZUL (C139718.0000)	20u.	USD 0,66 IVA 21%

# ■ BORNE PORTAFUSIBLE ASK1 Y KDKS1 (FUSIBLE 20X5 MM)

## BORNE PORTAFUSIBLE ASK1

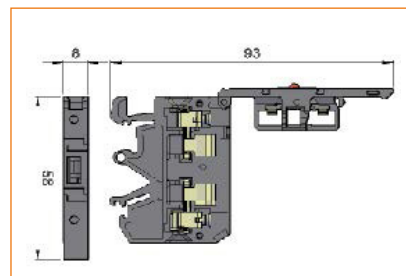
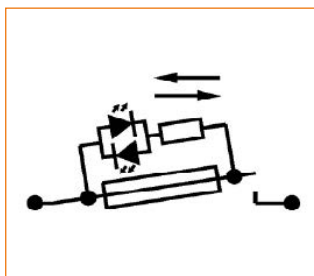

CÓD. FABRICANTE	SKU	DESCRIPCIÓN	MASTER	PRECIO
C047456.0000	ASK1	BORNERA PORTAFUSIBLE SIMPLE PISO ASK1 BEIGE sin LED (apto seccionador) (C047456.0000)	50u.	USD 4,20 IVA 21%
C905095.2000	ASK1 LD 24VCC	BORNERA PORTAFUSIBLE SIMPLE PISO ASK1 BEIGE con Led 24VCC (C905095.2000)	50u.	USD 10,25 IVA 21%
C905085.200A	ASK1 LD 220VCA	BORNERA PORTAFUSIBLE SIMPLE PISO ASK1 BEIGE con Led 220VAC (C905085.200A)	50u.	USD 12,85 IVA 21%
C906879.6000	ASK1 BK	BORNERA PORTAFUSIBLE SIMPLE PISO sin led ASK1 NEGRO (C906879.6000)	50u.	USD 6,95 IVA 21%
C906778.2000	ASK1 BID LD 10-60V BK	BORNERA PORTAFUSIBLE SIMPLE PISO ASK1 NEGRO BID LD 10..60V (C906778.2000)	50u.	USD 11,81 IVA 21%
C906779.2000	ASK1 BID LD 85-250V BK	BORNERA PORTAFUSIBLE SIMPLE PISO ASK1 NEGRO BID LD 85..250V (C906779.2000)	50u.	USD 15,85 IVA 21%

# ■ BORNE PORTAFUSIBLE ASK1 Y KDKS1 (FUSIBLE 20X5 MM)

## BORNE PORTAFUSIBLE KDKS1

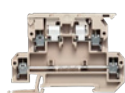
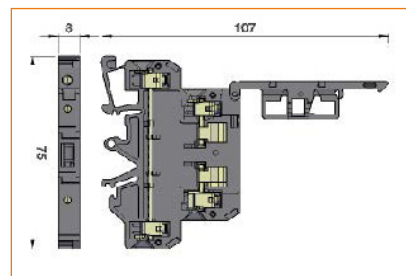
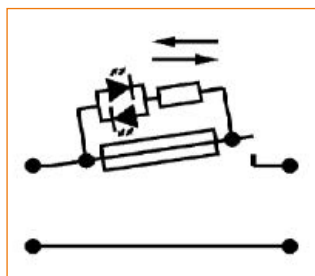

CÓD. FABRICANTE	SKU	DESCRIPCIÓN	MASTER	PRECIO
C950335.6000	KDKS1	BORNERA PORTAFUSIBLE DOBLE PISO KDKS1 BEIGE SIN LED (C950335.6000)	50u.	USD 5,89 IVA 21%
C905102.2000	KDKS1 LD 24VCC LD VMBC	BORNERA PORTAFUSIBLE DOBLE PISO KDKS1 BEIGE LED 24 VDC BC (C905102.2000)	50u.	USD 11,62 IVA 21%
C903871.6000	KDKS1 220VCA LD VM	BORNERA PORTAFUSIBLE DOBLE PISO KDKS1 BEIGE LED 220 VAC (C903871.6000)	50u.	USD 16,50 IVA 21%
C906880.6000	KDKS1 BK	BORNERA PORTAFUSIBLE DOBLE PISO KDKS1 NEGRO SIN LED (C906880.6000)	50u.	USD 10,18 IVA 21%
C906774.2000	KDKS1 BID LD 10-60V BK	BORNERA PORTAFUSIBLE DOBLE PISO KDKS1 NEGRO BID LD 10..60V (C906774.2000)	50u.	USD 15,95 IVA 21%
C906775.2000	KDKS1 BID LD 85-250V BK	BORNERA PORTAFUSIBLE DOBLE PISO KDKS1 NEGRO LD 85..250V (C906775.2000)	50u.	USD 17,85 IVA 21%



# ■ BORNE PORTAFUSIBLE ASK1 Y KDKS1 (FUSIBLE 20X5 MM)

## ACCESORIOS BORNES PORTAFUSIBLES ASK1 Y KDKS1

	CÓD. FABRICANTE	SKU	DESCRIPCIÓN	MASTER	PRECIO
	545400000	QB 58/8/15	Peine 58 polos ISPF QB58 SW (545400000)	10u.	USD 7,78 IVA 21%
	546000000	ISPF QB58 SW	Cubre Peine de 58 polos NEGRO (546000000)	10u.	USD 3,22 IVA 21%
	546040000	ISPF QB58 RT	Cubre Peine de 58 polos ROJO (546040000)	10u.	USD 3,93 IVA 21%
	546080000	ISPF QB58 BL	Cubre Peine de 58 polos AZUL (546080000)	10u.	USD 4,20 IVA 21%
	461100000	QB 2 WI RA8 IS	PUENTE ASK y KDKS 2 polos QB 2 WI RA8 IS (461100000)	50u.	USD 1,96 IVA 21%
	461200000	QB 3 WI RA8 IS	PUENTE ASK y KDKS 3 polos QB 3 WI RA8 IS (461200000)	50u.	USD 2,50 IVA 21%
	461300000	QB 4 WI RA8 IS	PUENTE ASK y KDKS 4 polos QB 4 WI RA8 IS (461300000)	50u.	USD 2,94 IVA 21%
	C038036.0000	AP ASK1	TAPA AP ASK1 BEIGE (C038036.0000)	20u.	USD 0,60 IVA 21%
	C906868.6000	AP ASK1 BK	TAPA AP PAASK 1 NEGRO (simple piso) (C906868.6000)	20u.	USD 0,85 IVA 21%
	C950333.6000	AP KDKS1 BRZ	TAPA KDKS1 BEIGE (doble piso) (C950333.6000)	20u.	USD 0,61 IVA 21%
	C906869.6000	AP KDKS1 BK	TAPA AP PA KDKS1 NEGRO (doble piso) (C906869.6000)	20u.	USD 0,93 IVA 21%
	285100000	VH 19/5/3.5 SAK4-16	Cilindro de conexión 20x5 mm para utilizar al portafusible c/ seccionador VH 19/5/3.5 (285100000)	50u.	USD 1,37 IVA 21%
	1269070000	ZST 1	PORTA FUSIBLES 5x20 de repuesto ZST1 NEGRO (1269070000)	25u.	USD 11,02 IVA 21%

# ■ BORNE PORTAFUSIBLE ASK1 Y KDKS1 (FUSIBLE 20X5 MM)

## FUSIBLE PARA ASK Y KDKS (20X5 MM)

Fusible Vidrio



CÓD. FABRICANTE	SKU	DESCRIPCIÓN	MASTER	PRECIO
C902482.0000	Fu 5x20 0,5A	FUSIBLE VIDRIO 0,5A 5X20 MM FUS500mAEL - TEA (C902482.0000)	100u.	USD 0,54 IVA 21%
C902481.0000	Fu 5x20 1A	FUSIBLE VIDRIO 1A 5X20 MM FUS1AEL - TEA (C902481.0000)	100u.	USD 0,59 IVA 21%
C902480.0000	Fu 5x20 2A	FUSIBLE VIDRIO 2A 5X20 MM FUS2AEL - TEA (C902480.0000)	100u.	USD 0,59 IVA 21%
C902479.0000	Fu 5x20 4A	FUSIBLE VIDRIO 4A 5X20 MM FUS4AEL - TEA (C902479.0000)	100u.	USD 0,59 IVA 21%
C902477.0000	Fu 5x20 10A	FUSIBLE VIDRIO 10A 5X20 MM FUS 10A EL - TEA (C902477.0000)	100u.	USD 0,51 IVA 21%

■ BORNE PORTAFUSIBLE WSI 25 (10 X 38)  
Y BORNE DE EMPALME AÉREO REUTILIZABLE

BASE PORTAFUSIBLES WSI 25 (10X38)



CÓD. FABRICANTE	SKU	DESCRIPCIÓN	MASTER	PRECIO
1966020000	WSI 25/1 10X38	BASE PORTAFUSIBLES, Conexión brida-tornillo, BEIGE OSCURO, 25 mm <sup>2</sup> , 32 A, 690 V (1966020000)	12u.	USD 18,35 <small>IVA 21%</small>
1137790000	WSI 25/1 10X38 1KV	BASE PORTAFUSIBLES, Conexión brida-tornillo, BEIGE OSCURO, 25 mm <sup>2</sup> , 30 A, 1000 V (1137790000)	12u.	USD 16,85 <small>IVA 21%</small>
1966060000	WSI 25/1 10X38/LED 690V	BASE PORTAFUSIBLES con LED 690V, Conexión brida-tornillo, BEIGE OSCURO, 25 mm <sup>2</sup> , 32 A, 690 V, (1966060000)	12u.	USD 33,92 <small>IVA 21%</small>

BORNE DE EMPALME AÉREO REUTILIZABLE

✓ Hasta 450V, 24 A (IEC), conductores desde 0,2 a 2,5mm<sup>2</sup>



Punto de prueba accesible

✓ Indicador de decapado, apto cables rígidos y flexibles



Reduce el tiempo de instalación hasta 50%

✓ Conexión PUSH IN Seguro, rápido y reutilizable



Diseño práctico, discreto



CÓD. FABRICANTE	SKU	DESCRIPCIÓN	MASTER	PRECIO
C906983.0000	Emp 2 VIAS 2,5mm <sup>2</sup>	BORNE DE EMPALME Weidmüller CONEXEL 2 VIAS h/2,5mm <sup>2</sup> (C906983.0000)	100u.	USD 2,50 <small>IVA 21%</small>
C906984.0000	Emp 3 VIAS 2,5mm <sup>2</sup>	BORNE DE EMPALME Weidmüller CONEXEL 3 VIAS h/2,5mm <sup>2</sup> (C906984.0000)	100u.	USD 3,10 <small>IVA 21%</small>
C906985.0000	Emp 5 VIAS 2,5mm <sup>2</sup>	BORNE DE EMPALME Weidmüller CONEXEL 5 VIAS h/2,5mm <sup>2</sup> (C906985.0000)	100u.	USD 2,95 <small>IVA 21%</small>

## CONEXIÓN MÁS RÁPIDA QUE NUNCA



La innovadora tecnología de conexión SNAP IN permite un cableado seguro en un tiempo récord. Con SNAP IN, incluso los conductores flexibles sin terminales pueden conectarse de forma intuitiva y sin herramientas, incluso en procesos de cableado totalmente automatizados. Como pioneros en el campo de la fabricación de paneles, llevamos años dando forma al mercado. Con la nueva tecnología de conexión SNAP IN, podemos llevar tus procesos de cableado a un nivel completamente nuevo.

### BORNES DE PASO SNAP IN 2,5 MM<sup>2</sup>



### SNAP IN

#### Borne de paso

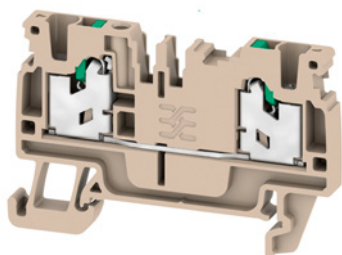

#### Borne de tierra

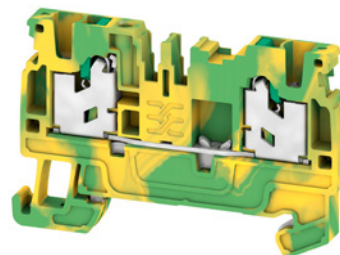

CÓD. FABRICANTE	SKU	DESCRIPCIÓN	MASTER	PRECIO
2674530000	S2C 2.5	BORNE DE PASO, SNAP IN, BEIGE OSCURO, 2,5 mm <sup>2</sup> , 24 A, 800 V, Número de conexiones: 2 S2C 2.5 (2674530000)	100u.	USD 3,23 IVA 21%
2753940000	S2C 2.5 BL	BORNE DE PASO, SNAP IN, AZUL, 2,5 mm <sup>2</sup> , 24 A, 800 V, Número de conexiones: 2 S2C 2.5 BL (2753940000)	100u.	USD 3,23 IVA 21%
2875120000	S2C 2.5 OR	BORNE DE PASO, SNAP IN, NARANJA, 2,5 mm <sup>2</sup> , 24 A, 800 V, Número de conexiones: 2 S2C 2.5 OR (2875120000)	100u.	USD 3,63 IVA 21%
2674560000	S2C 2.5 PE	BORNE DE TIERRA, SNAP IN, VERDE/AMARILLO, 2,5 mm <sup>2</sup> , 800 V, Número de conexiones: 2, Número de pisos: 1, S2C 2.5 PE (2674560000)	50u.	USD 10,55 IVA 21%



# ■ BORNE DE CONEXIÓN ULTRA RÁPIDA SNAP IN (LIBRE DE MANTENIMIENTO)

ACCESORIOS BORNES DE PASO SNAP IN 2,5 MM<sup>2</sup>

## SNAP IN

Puente Naranja



Tapa SEP

CÓD. FABRICANTE	SKU	DESCRIPCIÓN	MASTER	PRECIO
1527540000	ZQV 2.5N/2	PUENTE NARANJA, 24 A, Número de polos: 2, Paso en mm (P): 5.10, Aislado: Sí, Anchura: 7.9 mm (1527540000)	60u.	USD 1,16 IVA 21%
1527690000	ZQV 2.5N/10	PUENTE NARANJA, 24 A, Número de polos: 10, Paso en mm (P): 5.10, Aislado: Sí, Anchura: 48.7 mm (1527690000)	20u.	USD 5,23 IVA 21%
2751080000	SEP 2C 2.5	TAPA SEP 2C 2.5 (2751080000)	20u.	USD 1,36 IVA 21%

■ BORNE DE PASO WEIDMÜLLER A PUSH IN (LIBRE DE MANTENIMIENTO)



BORNES DE PASO PUSH IN 1,5 MM<sup>2</sup>



CÓD. FABRICANTE	SKU	DESCRIPCIÓN	MASTER	PRECIO
1552790000	A2C 1.5	Borne de paso, PUSH IN, 1.5 mm <sup>2</sup> , 500 V, 17.5 A, Beige oscuro A2C 1.5 (1552790000)	100u.	USD 1,42 <small>IVA 21%</small>
2508170000	A2C 1.5 BK	Borne de paso, PUSH IN, 1.5 mm <sup>2</sup> , 500 V, 17.5 A, negro A2C 1.5 BK (2508170000)	100u.	USD 1,41 <small>IVA 21%</small>
1552820000	A2C 1.5 BL	BORNE DE PASO, PUSH IN, 1.5 mm <sup>2</sup> , 500 V, 17.5 A, AZUL A2C 1.5 BL (1552820000)	100u.	USD 1,41 <small>IVA 21%</small>
2508200000	A2C 1.5 BR	BORNE DE PASO, PUSH IN, 1.5 mm <sup>2</sup> , 500 V, 17.5 A, MARRON A2C 1.5 BR (2508200000)	100u.	USD 1,41 <small>IVA 21%</small>
2508180000	A2C 1.5 DBL	BORNE DE PASO, PUSH IN, 1.5 mm <sup>2</sup> , 500 V, 17.5 A, AZUL OSCURO A2C 1.5 DBL (2508180000)	100u.	USD 1,41 <small>IVA 21%</small>
2508210000	A2C 1.5 GN	BORNE DE PASO, PUSH IN, 1.5 mm <sup>2</sup> , 500 V, 17.5 A, VERDE A2C 1.5 GN (2508210000)	100u.	USD 1,46 <small>IVA 21%</small>
2508220000	A2C 1.5 LTGY	BORNE DE PASO, PUSH IN, 1.5 mm <sup>2</sup> , 500 V, 17.5 A, GRIS claro A2C 1.5 LTGY (2508220000)	100u.	USD 1,46 <small>IVA 21%</small>
1552830000	A2C 1.5 OR	BORNE DE PASO, PUSH IN, 1.5 mm <sup>2</sup> , 500 V, 17.5 A, NARANJA A2C 1.5 OR (1552830000)	100u.	USD 1,46 <small>IVA 21%</small>
2508020000	A2C 1.5 RD	BORNE DE PASO, PUSH IN, 1.5 mm <sup>2</sup> , 500 V, 17.5 A, ROJO A2C 1.5 RD (2508020000)	100u.	USD 1,46 <small>IVA 21%</small>
2508160000	A2C 1.5 WT	BORNE DE PASO, PUSH IN, 1.5 mm <sup>2</sup> , 500 V, 17.5 A, BLANCO A2C 1.5 WT (2508160000)	100u.	USD 1,46 <small>IVA 21%</small>
2508190000	A2C 1.5 YL	BORNE DE PASO, PUSH IN, 1.5 mm <sup>2</sup> , 500 V, 17.5 A, AMARILLO A2C 1.5 YL (2508190000)	100u.	USD 1,46 <small>IVA 21%</small>

■ BORNE DE PASO WEIDMÜLLER A PUSH IN (LIBRE DE MANTENIMIENTO)

ACCESORIOS BORNES DE PASO PUSH IN 1,5 MM<sup>2</sup>

Puente Naranja



Tapa AEP



CÓD. FABRICANTE	SKU	DESCRIPCIÓN	MASTER	PRECIO
1985410000	ZQV 1.5N/2	PUENTE - ZQV 1.5N/2 (1985410000)	60u.	USD 1,16 IVA 21%
1985580000	ZQV 1.5N/10	PUENTE - ZQV 1.5N/10 (1985580000)	20u.	USD 9,14 IVA 21%
1552600000	AEP 2C 1.5	TAPA AEP 2C 1.5 (1552600000)	50u.	USD 1,18 IVA 21%
1552610000	AEP 2C 1.5 BL	TAPA AEP 2C 1.5 BL (1552610000)	50u.	USD 1,17 IVA 21%

BORNES DE PASO PUSH IN 4 MM<sup>2</sup> Y 6 MM<sup>2</sup>



Borne de paso

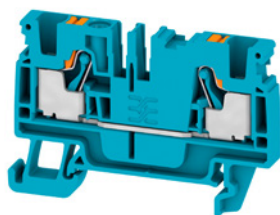



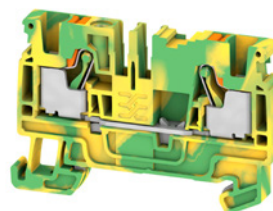



Borne de tierra



CÓD. FABRICANTE	SKU	DESCRIPCIÓN	MASTER	PRECIO
2051180000	A2C 4	BORNE DE PASO, PUSH IN, 4 mm <sup>2</sup> , 800 V, 32 A, BEIGE OSCURO A2C 4 (2051180000)	100u.	USD 1,97 IVA 21%
1992110000	A2C 6	BORNE DE PASO, PUSH IN, 6 mm <sup>2</sup> , 800 V, 41 A, BEIGE OSCURO A2C 6 (1992110000)	50u.	USD 3,07 IVA 21%
2051210000	A2C 4 BL	BORNE DE PASO, PUSH IN, 4 mm <sup>2</sup> , 800 V, 32 A, AZUL A2C 4 BL (2051210000)	100u.	USD 1,97 IVA 21%
1991790000	A2C 6 BL	BORNE DE PASO, PUSH IN, 6 mm <sup>2</sup> , 800 V, 41 A, AZUL A2C 6 BL (1991790000)	50u.	USD 3,07 IVA 21%
2051360000	A2C 4 PE	BORNE DE TIERRA, PUSH IN, 4 mm <sup>2</sup> , VERDE/AMARILLO A2C 4 PE (2051360000)	100u.	USD 3,56 IVA 21%
1991810000	A2C 6 PE	BORNE DE TIERRA, PUSH IN, 6 mm <sup>2</sup> , VERDE/AMARILLO A2C 6 PE (1991810000)	50u.	USD 8,22 IVA 21%

■ BORNE DE PASO WEIDMÜLLER A PUSH IN (LIBRE DE MANTENIMIENTO)

ACCESORIOS BORNES DE PASO PUSH IN 4 MM<sup>2</sup> Y 6 MM<sup>2</sup>

CÓD. FABRICANTE	SKU	DESCRIPCIÓN	MASTER	PRECIO
	1527930000	ZQV 4N/2	PUENTE NARANJA, 32 A, Número de polos: 2, Paso en mm (P): 6.10, Aislado: Sí, Anchura: 9.9 mm (1527930000)	60u. USD 1,28 IVA 21%
	1985740000	ZQV 6N/2	PUENTE - ZQV 6N/2 (1985740000)	60u. USD 1,48 IVA 21%
	1527940000	ZQV 4N/3	PUENTE NARANJA, 32 A, Número de polos: 3, Paso en mm (P): 6.10, Aislado: Sí, Anchura: 16 mm (1527940000)	60u. USD 3,07 IVA 21%
	1985760000	ZQV 6N/3	PUENTE - ZQV 6N/3 (1985760000)	60u. USD 2,93 IVA 21%
	1527970000	ZQV 4N/4	PUENTE NARANJA, 32 A, Número de polos: 4, Paso en mm (P): 6.10, Aislado: Sí, Anchura: 22.1 mm (1527970000)	60u. USD 3,35 IVA 21%
	1985780000	ZQV 6N/4	PUENTE - ZQV 6N/4 (1985780000)	60u. USD 4,36 IVA 21%
	1528090000	ZQV 4N/10	PUENTE NARANJA, 32 A, Número de polos: 10, Paso en mm (P): 6.10, Aislado: Sí, Anchura: 58.7 mm (1528090000)	20u. USD 6,90 IVA 21%
	1528130000	ZQV 4N/50	PUENTE NARANJA, 32 A, Número de polos: 50, Paso en mm (P): 6.10, Aislado: Sí, Anchura: 303.7 mm (1528130000)	5u. USD 85,50 IVA 21%
	1521530000	AEP 4C 2.5	TAPA AEP 4C 2.5 (1521530000)	50u. USD 1,39 IVA 21%
	1991970000	AEP 2C 6	TAPA AEP 2C 6 (1991970000)	50u. USD 1,05 IVA 21%
	1521640000	AEP 4C 2.5 BL	TAPA AEP 4C 2.5 BL (1521640000)	50u. USD 1,39 IVA 21%
	1991950000	AEP 2C 6 BL	TAPA AEP 2C 6 BL (1991950000)	50u. USD 1,75 IVA 21%

BORNES DE PASO PUSH IN 10 MM<sup>2</sup> y 16 MM<sup>2</sup>



CÓD. FABRICANTE	SKU	DESCRIPCIÓN	MASTER	PRECIO
	2490360000	A2C 10	BORNE DE PASO, PUSH IN, 10 mm <sup>2</sup> , 1000 V, 57 A, BEIGE OSCURO A2C 10 (2490360000)	25u. USD 4,32 IVA 21%
	2494000000	A2C 16	BORNE DE PASO, PUSH IN, 16 mm <sup>2</sup> , 1000 V, 76 A, BEIGE OSCURO A2C 16 (2494000000)	20u. USD 4,46 IVA 21%
	2490370000	A2C 10 BL	BORNE DE PASO, PUSH IN, 10 mm <sup>2</sup> , 1000 V, 57 A, AZUL A2C 10 BL (2490370000)	25u. USD 4,32 IVA 21%
	2494100000	A2C 16 BL	BORNE DE PASO, PUSH IN, 16 mm <sup>2</sup> , 1000 V, 76 A, AZUL A2C 16 BL (2494100000)	20u. USD 4,46 IVA 21%
	2490440000	A2C 10 PE	BORNE DE TIERRA, PUSH IN, 10 mm <sup>2</sup> , VERDE/AMARILLO A2C 10 PE (2490440000)	25u. USD 10,84 IVA 21%
	2494010000	A2C 16 PE	BORNE DE TIERRA, PUSH IN, 16 mm <sup>2</sup> , 1000 V, VERDE/AMARILLO A2C 16 PE (2494010000)	20u. USD 10,84 IVA 21%

# BORNE DE PASO WEIDMÜLLER A PUSH IN (LIBRE DE MANTENIMIENTO)

## ACCESORIOS BORNES DE PASO PUSH IN 10 MM<sup>2</sup> y 16 MM<sup>2</sup>



CÓD. FABRICANTE	SKU	DESCRIPCIÓN	MASTER	PRECIO
2497250000	ZQV 10N/2	PUENTE NARANJA, 57 A, Número de polos: 2, Paso en mm (P): 10.00, Aislado: Sí, ZQV 10N/2 (2497250000)	25u.	USD 3,09 IVA 21%
2497290000	ZQV 16N/2	PUENTE NARANJA, 76 A, Número de polos: 2, Paso en mm (P): 12.00, Aislado: Sí, ZQV 16N/2 (2497290000)	25u.	USD 4,15 IVA 21%
2490380000	AEP 2C 10/16	TAPA AEP 2C 10/16 (2490380000)	20u.	USD 1,98 IVA 21%
2490390000	AEP 2C 10/16 BL	TAPA AEP 2C 10/16 BL (2490390000)	20u.	USD 1,98 IVA 21%

## BORNES DE PASO PUSH IN 35 MM<sup>2</sup>

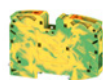

CÓD. FABRICANTE	SKU	DESCRIPCIÓN	MASTER	PRECIO
2551510000	A2C 35	BORNE DE PASO, PUSH IN, 35 mm <sup>2</sup> , 1000 V, 125 A, BEIGE OSCURO A2C 35 (2551510000)	10u.	USD 11,48 IVA 21%
2552090000	A2C 35 BL	BORNE DE PASO, PUSH IN, 35 mm <sup>2</sup> , 1000 V, 125 A, AZUL A2C 35 BL (2552090000)	10u.	USD 11,48 IVA 21%
2551520000	A2C 35 PE	BORNE DE TIERRA, PUSH IN, 35 mm <sup>2</sup> , 1000 V, VERDE/AMARILLO A2C 35 PE (2551520000)	10u.	USD 16,95 IVA 21%

## ACCESORIOS BORNES DE PASO PUSH IN 35 MM<sup>2</sup>



CÓD. FABRICANTE	SKU	DESCRIPCIÓN	MASTER	PRECIO
2634950000	ZQV 35N/2	PUENTE NARANJA, 125 A, Número de polos: 2, Paso en mm (P): 16.00, Aislado: Sí, ZQV 35N/2 (2634950000)	10u.	USD 4,49 IVA 21%
2562670000	ZQV 35N-10	PUENTE NARANJA, 57 A, Número de polos: 2, Paso en mm (P): 16.30, Aislado: Sí, ZQV 35N-10 (2562670000)	10u.	USD 6,55 IVA 21%
2562660000	ZQV 35N-16	PUENTE NARANJA, 76 A, Número de polos: 2, Paso en mm (P): 17.80, Aislado: Sí, ZQV 35N-16 (2562660000)	10u.	USD 6,56 IVA 21%

## SERIE A - ÁNGULO DE FIJACIÓN LATERAL



CÓD. FABRICANTE	SKU	DESCRIPCIÓN	MASTER	PRECIO
1991920000	AEB 35 SC/1	SERIE A, Ángulo de fijación lateral AEB 35 SC/1 (1991920000)	50u.	USD 1,78 IVA 21%
2661280000	AEB 35 SCL/1 V0	SERIE A, Ángulo de fijación lateral AEB 35 SCL/1 V0 (2661280000)	20u.	USD 1,15 IVA 21%

## BORNE DE DOBLE PISO SERIE PUSH IN A2T



CÓD. FABRICANTE	SKU	DESCRIPCIÓN	MASTER	PRECIO
2675110000	A2T 2.5 DL	BORNE DE PASO, Bornes de doble piso, PUSH IN, 2.5 mm <sup>2</sup> , 800 V, 24 A, BEIGE OSCURO A2T 2.5 DL (2675110000)	50u.	USD 7,09 IVA 21%

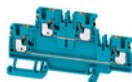

2675120000	A2T 2.5 DL BL	BORNE DE PASO, Bornes de doble piso, PUSH IN, 2.5 mm <sup>2</sup> , 800 V, 24 A, AZUL A2T 2.5 DL BL (2675120000)	50u.	USD 7,09 IVA 21%
------------	---------------	--	------	---------------------



2744110000	A2T 2.5 DT/DT	BORNE SECCIONABLE Y DE MEDICIÓN, PUSH IN, 2.5 mm <sup>2</sup> , 400 V, 16 A, BEIGE OSCURO A2T 2.5 DT/DT (2744110000)	50u.	USD 24,73 IVA 10.5%
------------	---------------	--	------	------------------------

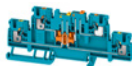

2744120000	A2T 2.5 DT/DT BL	BORNE SECCIONABLE Y DE MEDICIÓN, PUSH IN, 2.5 mm <sup>2</sup> , 400 V, 16 A, AZUL A2T 2.5 DT/DT BL (2744120000)	50u.	USD 24,73 IVA 10.5%
------------	------------------	---	------	------------------------



2744130000	A2T 2.5 DT/FT	BORNE SECCIONABLE Y DE MEDICIÓN, PUSH IN, 2.5 mm <sup>2</sup> , 800 V, 16 A, BEIGE OSCURO A2T 2.5 DT/FT (2744130000)	50u.	USD 21,64 IVA 10.5%
------------	---------------	--	------	------------------------



1547640000	A2T 2.5 FT-PE	BORNE DE PASO, Bornes de doble piso, PUSH IN, 2.5 mm <sup>2</sup> , 800 V, 24 A, BEIGE OSCURO (1547640000)	50u.	USD 5,63 IVA 21%
------------	---------------	--	------	---------------------

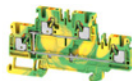

1547680000	A2T 2.5 PE	BORNE DE TIERRA, PUSH IN, 2.5 mm <sup>2</sup> , 800 V, VERDE/AMARILLO (1547680000)	50u.	USD 13,57 IVA 21%
------------	------------	--	------	----------------------



2675140000	A2T 2.5 VL DL	BORNE DE PASO, Bornes de doble piso, PUSH IN, 2.5 mm <sup>2</sup> , 800 V, 24 A, BEIGE OSCURO A2T 2.5 VL DL (2675140000)	50u.	USD 13,34 IVA 21%
------------	---------------	--	------	----------------------

## ACCESORIOS BORNE DOBLE PASO A2T



1547690000	AEP 2T 2.5	TAPA AEP 2T 2.5 (1547690000)	20u.	USD 1,26 IVA 21%
------------	------------	------------------------------	------	---------------------

BORNE PORTAFUSIBLE PUSH IN 4 MM<sup>2</sup>

AFS 4 2C



A2T 4 FS

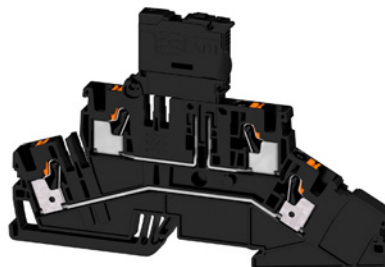

CÓD. FABRICANTE	SKU	DESCRIPCIÓN	MASTER	PRECIO
2434390000	AFS 4 2C 100-250V BK	BORNE PORTAFUSIBLES, PUSH IN, 4 mm <sup>2</sup> , 250 V, 6.3 A, NEGRO AFS 4 2C 100-250V BK (2434390000)	50u.	USD 17,51 IVA 21%
2429870000	AFS 4 2C 10-36V BK	BORNE PORTAFUSIBLES, PUSH IN, 4 mm <sup>2</sup> , 36 V, 6.3 A, NEGRO AFS 4 2C 10-36V BK (2429870000)	50u.	USD 18,16 IVA 21%
2429860000	AFS 4 2C BK	BORNE PORTAFUSIBLES, PUSH IN, 4 mm <sup>2</sup> , 400 V, 6.3 A, NEGRO AFS 4 2C BK (2429860000)	50u.	USD 10,81 IVA 21%
2548140000	AFS 4 2C BK/BL	BORNE PORTAFUSIBLES, PUSH IN, 4 mm <sup>2</sup> , 400 V, 6.3 A, NEGRO AFS 4 2C BK/BL (2548140000)	50u.	USD 10,81 IVA 21%
2816960000	A2T 4 FS-FT BK	BORNE PORTAFUSIBLES, PUSH IN, 4 mm <sup>2</sup> , 500 V, 6.3 A, NEGRO A2T 4 FS-FT BK (2816960000)	50u.	USD 16,58 IVA 21%
2831510000	A2T 4 FS-FT-PE	BORNE PORTAFUSIBLES, PUSH IN, 4 mm <sup>2</sup> , 500 V, 6.3 A, BEIGE OSCURO A2T 4 FS-FT-PE (2831510000)	50u.	USD 31,35 IVA 21%
2817010000	A2T 4 FS-FT-PE BK	BORNE PORTAFUSIBLES, PUSH IN, 4 mm <sup>2</sup> , 500 V, 6.3 A, NEGRO A2T 4 FS-FT-PE BK (2817010000)	50u.	USD 31,35 IVA 21%

# ELEMENTOS PARA SEÑALIZACIÓN GRUPO DE BORNES



click para ver el video

## Cobertores Plásticos



## Etiquetas p/ impresoras

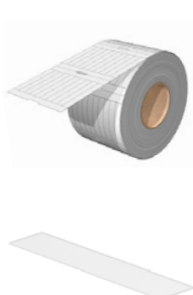

## Separador ancho



## Terminal Maker



## Señalizador conectores



## Accesorio para tope final



CÓD. FABRICANTE	SKU	DESCRIPCIÓN	MASTER	PRECIO
	1631930000	SCHT 5 S	SCHT, Terminal marker, 44.5 x 9.5 mm, Paso en mm (P): 5.00 (1631930000)	20u. USD 1,23 IVA 21%
	1631940000	STR 5 S F.SCHT 5 S	STR 5 S F.SCHT 5 S Cobertor plastico (1631940000)	20u. USD 0,69 IVA 21%
	2518620000	ELS 7/40 MM WS	ELS 7/40 MM WS Etiqueta para Impresora THM (2518620000)	3000u. USD 0,80 IVA 21%
	292460000	SCHT 5	SCHT 5 separador ancho 19,5 mm (292460000)	20u. USD 2,40 IVA 21%
	294000000	STR 5 F.SCHT 5	STR 5 F.SCHT 5 Cobertor plástico (294000000)	20u. USD 0,65 IVA 21%
	2005200000	ELS 16/40 MM WS	ELS, Señalizadores CONECTORes, 7 - 115 mm, 40 x 16 mm, BLANCO (2005200000)	2000u. USD 1,23 IVA 21%
	1528090000	EM 8/30	EM 8/30 Accesorio para tope final WEW 35/2 (1806120000)	50u. USD 0,98 IVA 21%
	1528090000	ELS 6/30 MM WS	ELS 6/30 Etiqueta para Impresora THM (2009980000)	3000u. USD 0,39 IVA 21%



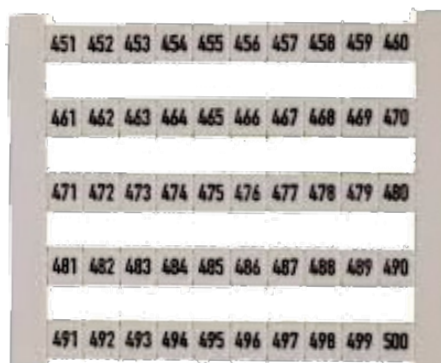

## IDENTIFICADORES 5X5 MM PARA BORNES / BORNES RELÉS / ACONDICIONADORES

### Rótulos Bornes



CÓD. FABRICANTE	SKU	DESCRIPCIÓN	MASTER	PRECIO
C047346.0001	DEKAFIX 5 FW 1-50	ROTULO BORNE DEKAFIX 5 FW 1- 50 (plancha) (C047346.0001)	60u.	USD 1,12 IVA 21%
C047346.0051	DEKAFIX 5 FW 51-100	ROTULO BORNE DEKAFIX 5 FW 51- 100 (plancha) (C047346.0051)	60u.	USD 1,34 IVA 21%
C047346.0101	DEKAFIX 5 FW 101-150	ROTULO BORNE DEKAFIX 5 FW 101- 150 (plancha) (C047346.0101)	60u.	USD 1,11 IVA 21%
C047346.0151	DEKAFIX 5 FW 151-200	ROTULO BORNE DEKAFIX 5 FW 151- 200 (plancha) (C047346.0151)	60u.	USD 1,27 IVA 21%
C047346.0201	DEKAFIX 5 FW 201-250	ROTULO BORNE DEKAFIX 5 FW 201- 250 (plancha) (C047346.0201)	60u.	USD 1,16 IVA 21%
C047346.0301	DEKAFIX 5 FW 301-350	ROTULO BORNE DEKAFIX 5 FW 301- 350 (plancha) (C047346.0301)	60u.	USD 1,38 IVA 21%
C047346.0351	DEKAFIX 5 FW 351-400	ROTULO BORNE DEKAFIX 5 FW 351- 400 (plancha) (C047346.0351)	60u.	USD 1,12 IVA 21%
C047346.0401	DEKAFIX 5 FW 401-450	ROTULO BORNE DEKAFIX 5 FW 401- 450 (plancha) (C047346.0401)	60u.	USD 1,12 IVA 21%
C047346.0451	DEKAFIX 5 FW 451-500	ROTULO BORNE DEKAFIX 5 FW 451- 500 (plancha) (C047346.0451)	60u.	USD 1,12 IVA 21%



	CÓD. FABRICANTE	SKU	DESCRIPCIÓN	MASTER	PRECIO
	C038340.0000	TS35 x 7,5 S/PERF	RIEL BAJO 35x7,5mm x 2m - Acero sin PERF (C038340.0000)	40u.	USD 12,91 IVA 21%
	C051450.0000	TS35 x 7,5 C/PERF	RIEL BAJO 35x7,5mm x 2m - Acero perforado (C051450.0000)	40u.	USD 12,43 IVA 21%
	C033080.0000	TS35 x 7,5 ALUMINIO	RIEL BAJO 35x7,5mm x 2m Aluminio sin PERF (C033080.0000)	96u.	USD 5,81 IVA 21%
	C023640.0000	TS35 x 15 S/PERF	RIEL ALTO 35x15mm x 2m- Acero sin PERF (C023640.0000)	20u.	USD 20,73 IVA 21%
	C023650.0000	TS35 x 15 C/PERF	RIEL ALTO 35x15mm x 2m- Acero perforado (C023650.0000)	20u.	USD 24,05 IVA 21%
	C016400.0000	TSTW C/M6	TSTW - soporte 35° para riel TS35/ TS32 M6 (C016400.0000)	20u.	USD 2,01 IVA 21%
	C905410.0000	TSTW ES C/M6	Soporte recto para riel TS35/ TS32 - M6 TSTW (C905410.0000)	20u.	USD 2,01 IVA 21%
	494920000	SH 2	TAPA de goma para RIEL 35X7.5 Cubierta de proteccion Polipropileno (1283470000)	10u.	USD 10,56 IVA 21%
	1283470000	TS END CAP 35X7.5	TAPA de goma para RIEL 35X7.5 Cubierta de proteccion Polipropileno (1283470000)	100u.	USD 1,21 IVA 10.5%
	9918700000	TSLD 5	Cortadora de Riel Din y barras de cobre TSLD 5 G32 (9918700000)	1u.	USD 8.449,16 IVA 10.5%

## ACCESORIOS ATERRAMIENTO

## CONECTOR PARA BARRA SIN AISLACIÓN



CÓD. FABRICANTE	SKU	DESCRIPCIÓN	MASTER	PRECIO
316500000	ZB 4	BORNE A BARRA de tierra, plata, 4 mm <sup>2</sup> , Anchura: 5.3 mm, M 3, Acero (316500000)	50u.	USD 0,95 <small>IVA 21%</small>



459500000	ZBE 6	BORNE A BARRA de tierra, plata, 6 mm <sup>2</sup> , Anchura: 8 mm, M 4, Acero (459500000)	50u.	USD 2,46 <small>IVA 21%</small>
-----------	-------	---	------	------------------------------------



1261300000	ZB 10 F.10X3	BORNE A BARRA de tierra ZB 10 F.10X3/10X5/10X10 (1261300000)	50u.	USD 2,36 <small>IVA 21%</small>
------------	--------------	--	------	------------------------------------



316600000	ZB 16 ZKSC	BORNE A BARRA de tierra, plata, 16 mm <sup>2</sup> , Anchura: 10 mm, M 4, Acero (316600000)	50u.	USD 1,68 <small>IVA 21%</small>
-----------	------------	---	------	------------------------------------



266500000	ZB 35/M6X16	BORNE A BARRA de tierra, plata, 35 mm <sup>2</sup> , Anchura: 14 mm, M 6, Acero (266500000)	20u.	USD 2,98 <small>IVA 21%</small>
-----------	-------------	---	------	------------------------------------

## CONECTOR PARA BARRA CON AISLACIÓN COLOR AZUL



CÓD. FABRICANTE	SKU	DESCRIPCIÓN	MASTER	PRECIO
475380000	ZB 4K BL	BORNE A BARRA de tierra, AZUL, 4 mm <sup>2</sup> , Anchura: 6 mm, M 3, Acero (475380000)	50u.	USD 2,89 <small>IVA 21%</small>



525980000	ZBE 6K BL	BORNE A BARRA ZBE 6 K AZUL (525980000)	50u.	USD 4,46 <small>IVA 21%</small>
-----------	-----------	--	------	------------------------------------



502880000	ZB 16K BL	BORNE A BARRA ZB 16 K AZUL (502880000)	50u.	USD 1,65 <small>IVA 21%</small>
-----------	-----------	--	------	------------------------------------



502680000	ZB 35K BL M6X16	BORNE A BARRA ZB 35 K AZUL (502680000)	20u.	USD 3,96 <small>IVA 21%</small>
-----------	-----------------	--	------	------------------------------------

## CONECTOR PARA BARRA CON AISLACIÓN COLOR VE/AM



CÓD. FABRICANTE	SKU	DESCRIPCIÓN	MASTER	PRECIO
475380000	ZB 4K GE/GN	BORNE A BARRA de tierra, VERDE/AMARILLO, 4 mm <sup>2</sup> , Anchura: 6 mm, M 3, Acero (475360000)	50u.	USD 1,35 IVA 21%



525980000	ZBE 6K GE/GN	BORNE A BARRA ZBE 6 K (525960000)	50u.	USD 4,38 IVA 21%
-----------	--------------	-----------------------------------	------	---------------------



502880000	ZB 16K GE/GN	BORNE A BARRA ZB 16 K VERDE/AM (502860000)	50u.	USD 2,97 IVA 21%
-----------	--------------	--	------	---------------------



502680000	ZB 35K GE/GN M6X16	BORNE A BARRA ZB 35 K VERDE/AM (502660000)	20u.	USD 3,96 IVA 21%
-----------	--------------------	--	------	---------------------

## CONECTOR DE MALLA PARA BARRA



CÓD. FABRICANTE	SKU	DESCRIPCIÓN	MASTER	PRECIO
1675350000	KLBUE 2X2-6	Brida para aterramiento KLBUE 2X2-6 (1675350000)	10u.	USD 15,56 IVA 21%



1600480000	KLBUE 3-8	Brida para aterramiento KLBUE 3-8 (1600480000)	10u.	USD 10,86 IVA 21%
------------	-----------	--	------	----------------------

## CONECTOR DE MALLA PARA RIEL DIN



CÓD. FABRICANTE	SKU	DESCRIPCIÓN	MASTER	PRECIO
1252520000	KLBUE 4-13.5 FM4	BORNE APANTALLAMIENTO A RIEL DIN KLBUE 4-13.5 FM4 (1252520000)	10u.	USD 26,61 IVA 21%



1252530000	KLBUE 3-8 FM4	BORNE APANTALLAMIENTO A RIEL DIN KLBUE 3-8 FM4 (1252530000)	10u.	USD 23,61 IVA 21%
------------	---------------	---	------	----------------------



687900000	FM 4/TS35	FIJACION A RIEL DIN FM 4/TS35 (687900000)	40u.	USD 2,18 IVA 21%
-----------	-----------	---	------	---------------------



348900000	SSCH 10X3X1000 CU/SN	Barra de cobre SSCH 10X3X1000 CU/SN (348900000)	25u.	USD 33,45 IVA 21%
-----------	----------------------	---	------	----------------------



299860000	SH 1	SOPORTE AISLADO para barra de cobre SH 1 (299860000)	20u.	USD 1,41 IVA 21%
-----------	------	--	------	---------------------



1061200000	WEW 35/2	EXTREMO DE BORNERA WEW 35/2 BEIGE (1061200000)	50u.	USD 1,41 IVA 21%
------------	----------	--	------	---------------------





1068700000	WSH 1	Tope WSH 1 p/ fijacion a riel con soporte extendido para barra 10x3 (1068700000)	50u.	USD 6,35 IVA 21%
------------	-------	--	------	---------------------

	CÓD. FABRICANTE	SKU	DESCRIPCIÓN	MASTER	PRECIO
	1820840000	WDU 50N	BORNE DE PASO, Conexión brida-tornillo, BEIGE OSCURO, 50 mm <sup>2</sup> , 150 A, 1000 V (1820840000)	10u.	USD 14,15 IVA 21%
	9512190000	WDU 70N/35	BORNE CONEXIÓN brida-tornillo, BEIGE OSCURO, 70 mm <sup>2</sup> , 192 A, 1000 V, WDU 70N/35 (9512190000)	10u.	USD 19,06 IVA 21%
	9512190000	WDU 70N/35 BL	BORNE CONEXIÓN brida-tornillo, BEIGE OSCURO, 70 mm <sup>2</sup> , 192 A, 1000 V, WDU 70N/35 (9512190000)	10u.	USD 24,33 IVA 21%
	1024500000	WDU 120/150	BORNE DE PASO, Conexión brida-tornillo, BEIGE OSCURO, 120 mm <sup>2</sup> , 269 A, 1000 V (1024500000)	10u.	USD 77,96 IVA 21%
	1802780000	WDU 240	BORNE DE PASO, Conexión brida-tornillo, BEIGE OSCURO, 240 mm <sup>2</sup> , 415 A, 1000 V, WDU 240/35 (1802780000)	2u.	USD 97,63 IVA 21%
	1028600000	WFF 185	BORNE DE PASO, Sección nominal: 185 mm <sup>2</sup> , Conexión de espárrago WFF 185 BEIGE 1000 V / 353 A (1028600000)	4u.	USD 60,80 IVA 21%

## PUENTES BORNES DE POTENCIA

	CÓD. FABRICANTE	SKU	DESCRIPCIÓN	MASTER	PRECIO
	1834060000	WQV 50N/2	WQV 50N/2 PUENTE para WDU 50N150 A / 2 polos (1834060000)	5u.	USD 18,10 IVA 21%
	9512240000	WQV 70N/2	WQV 70N/2 PUENTE para WDU 70N192 A / 2 polos (9512240000)	5u.	USD 13,67 IVA 21%
	1063300000	WQV 120/2	WQV 120/2 PUENTE para WDU 120/150269 A / 2 polos (1063300000)	5u.	USD 39,94 IVA 21%
	1802790000	WQB 240/2	WQV 240/2 PUENTE para WDU 240/35320 A / 2 polos (1802790000)	5u.	USD 38,96 IVA 21%
	1065200000	WQL 2 WFF185	WQL 2 WFF185 PUENTE para WFF185353 A / 2 polos (1065200000)	5u.	USD 41,69 IVA 21%

## PROTECTORES PARA WFF 185

	CÓD. FABRICANTE	SKU	DESCRIPCIÓN	MASTER	PRECIO
	1064760000	WAH 185/300	WAH 185/300 TAPA BEIGE para WFF185 (1064760000)	10u.	USD 10,85 IVA 21%
	1064780000	WAH 185/300 BL	WAH 185/300 BL TAPA AZUL para WFF185 (1064780000)	10u.	USD 10,85 IVA 21%



CÓD. FABRICANTE	SKU	DESCRIPCIÓN	MASTER	PRECIO
1562000000	WPD 104 GY	WPD 104 Bloque de distribución GRIS - In 100A (1562000000)	1u.	USD 35,98 IVA 21%
1562210000	WPD 106 GY	WPD 106 Bloque de distribución GRIS - In 160A (1562210000)	1u.	USD 56,62 IVA 21%
1562100000	WPD 108 GY	WPD 108 Bloque de distribución GRIS - In 250A (1562100000)	1u.	USD 140,63 IVA 21%
1562090000	WPD 109 GY	WPD 109 Bloque de distribución GRIS - In 353A (1562090000)	1u.	USD 152,93 IVA 21%



Al & Cu  
aprobados  
según  
UL486E

\*Uso de cable de aluminio y cobre aprobado según UL486E

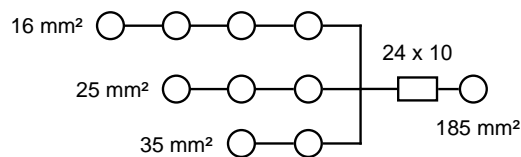
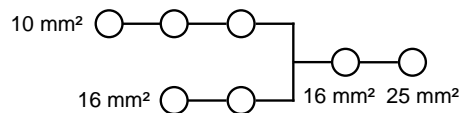



# ELECTRÓNICA INDUSTRIAL



FUENTES DE ALIMENTACIÓN



RELÉS Y OPTOACOPLORES



ACONDICIONADORES Y BARRERAS ATEX



DESCARGADORES DE SOBRETENSIÓN

 [click para ir a la web de cada categoría](#)

## FUENTES PRO INSTA



CÓD. FABRICANTE	SKU	DESCRIPCIÓN	MASTER	PRECIO
2580180000	PRO INSTA 16W 24V 0.7A	FUENTE SWITCHING MONOFASICA - PRO INSTA 16W 24V 0.7A (2580180000)	1u.	USD 83,16 IVA 21%
2580190000	PRO INSTA 30W 24V 1.3A	FUENTE SWITCHING MONOFASICA - PRO INSTA 30W 24V 1.3A (2580190000)	1u.	USD 120,96 IVA 21%
2580230000	PRO INSTA 60W 24V 2.5A	FUENTE SWITCHING MONOFASICA - PRO INSTA 60W 24V 2.5A (2580230000)	1u.	USD 157,50 IVA 21%
2580260000	PRO INSTA 96W 24V 4A	FUENTE SWITCHING MONOFASICA - PRO INSTA 96W 24V 4A (2580260000)	1u.	USD 194,04 IVA 21%
2580210000	PRO INSTA 30W 5V 6A	FUENTE SWITCHING MONOFASICA - PRO INSTA 30W 5V 6A (2580210000)	1u.	USD 131,04 IVA 21%
2580220000	PRO INSTA 30W 12V 2.6A	FUENTE SWITCHING MONOFASICA - PRO INSTA 30W 12V 2.6A (2580220000)	1u.	USD 120,96 IVA 21%
2580240000	PRO INSTA 60W 12V 5A	FUENTE SWITCHING MONOFASICA - PRO INSTA 60W 12V 5A (2580240000)	1u.	USD 157,50 IVA 21%
2580270000	PRO INSTA 96W 48V 2A	FUENTE SWITCHING MONOFASICA - PRO INSTA 96W 48V 2A (2580270000)	1u.	USD 194,04 IVA 21%

## FUENTES PRO MAX

## Potencia y durabilidad

Estas son las cualidades que diferencian nuestras fuentes de alimentación PROmax conmutadas de la competencia. Pueden hacer frente a sobrecorrientes continuas de hasta el 20%. Incluso las cargas máximas a corto plazo del 300% que se producen con temperaturas altas del armario de control no afectarán a estas fuentes.



CÓD. FABRICANTE	SKU	DESCRIPCIÓN	MASTER	PRECIO
147810000	PRO MAX 72W 24V 3A	FUENTE SWITCHING MONOFASICA PRO MAX 72W 24V 3A (1478100000)	1u.	USD 166,32 IVA 21%
147811000	PRO MAX 120W 24V 5A	FUENTE SWITCHING MONOFASICA PRO MAX 120W 24V 5A (1478110000)	1u.	USD 215,46 IVA 21%
147813000	PRO MAX 240W 24V 10A	FUENTE SWITCHING MONOFASICA PRO MAX 240W 24V 10A (1478130000)	1u.	USD 425,88 IVA 21%
147814000	PRO MAX 480W 24V 20A	FUENTE SWITCHING MONOFASICA PRO MAX 480W 24V 20A (1478140000)	1u.	USD 699,30 IVA 21%
147815000	PRO MAX 960W 24V 40A	FUENTE SWITCHING MONOFASICA PRO MAX 960W 24V 40A (1478150000)	1u.	USD 1.141,56 IVA 21%
147822000	PRO MAX 72W 12V 6A	FUENTE SWITCHING MONOFASICA PRO MAX 72W 12V 6A (1478220000)	1u.	USD 180,18 IVA 21%
147823000	PRO MAX 120W 12V 10A	FUENTE SWITCHING MONOFASICA PRO MAX 120W 12V 10A (1478230000)	1u.	USD 224,28 IVA 21%
147824000	PRO MAX 240W 48V 5A	FUENTE SWITCHING MONOFASICA PRO MAX 240W 48V 5A (1478240000)	1u.	USD 423,36 IVA 21%
147825000	PRO MAX 480W 48V 10A	FUENTE SWITCHING MONOFASICA PRO MAX 480W 48V 10A (1478250000)	1u.	USD 757,26 IVA 21%
147827000	PRO MAX 960W 48V 20A	FUENTE SWITCHING MONOFASICA PRO MAX 960W 48V 20A (1478270000)	1u.	USD 1291,50 IVA 21%
147817000	PRO MAX3 120W 24V 5A	FUENTE SWITCHING TRIFASICA PRO MAX3 120W 24V 5A (1478170000)	1u.	USD 321,30 IVA 21%
147818000	PRO MAX3 240W 24V 10A	FUENTE SWITCHING TRIFASICA PRO MAX3 240W 24V 10A (1478180000)	1u.	USD 423,36 IVA 21%
147819000	PRO MAX3 480W 24V 20A	FUENTE SWITCHING TRIFASICA PRO MAX3 480W 24V 20A (1478190000)	1u.	USD 631,26 IVA 21%
147820000	PRO MAX3 960W 24V 40A	FUENTE SWITCHING TRIFASICA PRO MAX3 960W 24V 40A (1478200000)	1u.	USD 1139,04 IVA 21%

## UPS, DIODOS Y BATERIAS



CÓD. FABRICANTE	SKU	DESCRIPCIÓN	MASTER	PRECIO
1370040010	CP DC UPS 24V 40A	UNIDAD DE CONTROL CP DC UPS 24V 40A (1370040010)	1u.	USD 1.323 IVA 10,5%
1370050010	CP DC UPS 24V 20A/10A	UNIDAD DE CONTROL CP DC UPS 24V 20A/10A (1370050010)	1u.	USD 781,20 IVA 10,5%
2486070000	PRO DM 10	MÓDULO DE DIODO, 24 V DC - PRO DM 10 (2486070000)	1u.	USD 204,58 IVA 21%
2486080000	PRO DM 20	MÓDULO DE DIODO, 24 V DC - PRO DM 20 (2486080000)	1u.	USD 204,73 IVA 21%
2486110000	PRO RM 40	MÓDULO DE DIODO, 24 V DC - PRO RM 40 (2486110000)	1u.	USD 606,06 IVA 10,5%
2486090000	PRO RM 10	MÓDULO DE DIODO, 24 V DC - PRO RM 10 (2486090000)	1u.	USD 391,43 IVA 10,5%
2486100000	PRO RM 20	MÓDULO DE DIODO, 24 V DC - PRO RM 20 (2486100000)	1u.	USD 513,31 IVA 10,5%
2789890000	DURAEKO LA-BAT 24V 1.2AH	BATERIA DURA ECO LA-BAT 24V 1.2AH (2789890000)	1u.	USD 431,85 IVA 21%
2789900000	DURAEKO LA-BAT 24V 3.4AH	BATERIA DURA ECO LA-BAT 24V 3.4AH (2789900000)	1u.	USD 333,65 IVA 21%



## CONVERSORES DE TENSIÓN DC/DC



CÓD. FABRICANTE	SKU	DESCRIPCIÓN	MASTER	PRECIO
2869010000	PRO DCDC 96W 24V/12V 8A	CONVERTIDOR DC/DC - PRO DCDC 96W 24V/12V 8A (2869010000)	1u.	USD 635,25 IVA 21%
2869020000	PRO DCDC 96W 48V/12V 8A	CONVERTIDOR DC/DC - PRO DCDC 96W 48V/12V 8A (2869020000)	1u.	USD 635,19 IVA 21%
2001800000	PRO DCDC 120W 24V 5A	CONVERTIDOR DC/DC - PRO DCDC 120W 24V 5A (2001800000)	1u.	USD 554,1 IVA 21%
2869040000	PRO DCDC 120W 48V/24V 5A	CONVERTIDOR DC/DC - PRO DCDC 120W 48V/24V 5A (2869040000)	1u.	USD 673,86 IVA 21%
2001810000	PRO DCDC 240W 24V 10A	CONVERTIDOR DC/DC - PRO DCDC 240W 24V 10A (2001810000)	1u.	USD 781,20 IVA 21%
2869050000	PRO DCDC 240W 24V/48V 5A	CONVERTIDOR DC/DC - PRO DCDC 240W 24V/48V 5A (2869050000)	1u.	USD 914,24 IVA 21%

## RELÉS DRM (2 Y 4 INVERSORES)



CÓD. FABRICANTE	SKU	DESCRIPCIÓN	MASTER	PRECIO
7760056068	DRM270012LT	RELE 2 INV. LED+test. Un 12 VDC, In : 10 A DRM270012LT (7760056068)	20u.	USD 8,67 IVA 21%
7760056069	DRM270024LT	RELE 2 INV. LED+test. Un 24 VDC, In : 10 A DRM270024LT (7760056069)	20u.	USD 9,09 IVA 21%
7760056071	DRM270110LT	RELE 2 INV. LED+test. Un 110 VDC, In : 10 A DRM270110LT (7760056071)	20u.	USD 9,40 IVA 21%
7760056072	DRM270220LT	RELE 2 INV. LED+test. Un 220 VDC, In : 10 A DRM270220LT (7760056072)	20u.	USD 12,04 IVA 21%
7760056096	DRM570012LT	RELE 4 INV. LED+test. Un 12 VDC, In : 5 A DRM570012LT (7760056096)	20u.	USD 9,08 IVA 21%
7760056097	DRM570024LT	RELE 4 INV. LED+test. Un 24 VDC, In : 5 A DRM570024LT (7760056097)	20u.	USD 10,50 IVA 21%
7760056099	DRM570110LT	RELE 4 INV. LED+test. Un 110 VDC, In : 5 A DRM570110LT (7760056099)	20u.	USD 9,86 IVA 21%
7760056100	DRM570220LT	RELE 4 INV. LED+test. Un 220 VDC, In : 5 A DRM570220LT (7760056100)	20u.	USD 12,6 IVA 21%
7760056073	DRM270524LT	RELE 2 INV. LED+test. Un 24 V AC, In : 10 A DRM270524LT (7760056073)	20u.	USD 9,09 IVA 21%
7760056075	DRM270615LT	RELE 2 INV. LED+test. Un 115 V AC, In : 10 A DRM270615LT (7760056075)	20u.	USD 10,22 IVA 21%
7760056076	DRM270730LT	RELE 2 INV. LED+test. Un 230 V AC, In : 10 A DRM270730LT (7760056076)	20u.	USD 10,68 IVA 21%
7760056101	DRM570524LT	RELE 4 INV. LED+test. Un 24 V AC, In : 5 A DRM570524LT (7760056101)	20u.	USD 9,67 IVA 21%
7760056103	DRM570615LT	RELE 4 INV. LED+test. Un 115 V AC, In : 5 A DRM570615LT (7760056103)	20u.	USD 9,68 IVA 21%
7760056104	DRM570730LT	RELE 4 INV. LED+test. Un 230 V AC, In : 5 A DRM570730LT (7760056104)	20u.	USD 10,08 IVA 21%



CÓD. FABRICANTE	SKU	DESCRIPCIÓN	MASTER	PRECIO
7760056106	FS 2CO	ZOCALO FS 2CO DRM, 2 inversores (7760056106)	10u.	USD 5,22 IVA 21%
7760056107	FS 4CO	ZOCALO FS 4CO DRM, 4 inversores (7760056107)	10u.	USD 6,19 IVA 21%
7760056264	SCM 4CO ECO	ZOCALO SCM 4CO ECO DRM triple piso (7760056264)	10u.	USD 7,12 IVA 21%
7760056108	DRM/DRL CLIP M	DRM/DRL CLIP M, Clip de retencion. (7760056108)	10u.	USD 0,23 IVA 21%

## TERMSERIES: RELES MODULARES A PARTIR DE 6MM DE ANCHO



CÓD. FABRICANTE	SKU	DESCRIPCIÓN	MASTER	PRECIO
2869010000	TRS 24VDC 1CO	RELE BORNERA, conexión a tornillo TRS 24VDC 1CO (1122770000)	10u.	USD 31,25 IVA 21%
1122750000	TRS 12VDC 1CO	RELE BORNERA, conexión a tornillo TRS 12VDC 1CO (1122750000)	10u.	USD 38,78 IVA 21%
1122780000	TRS 24VUC 1CO	RELE BORNERA, conexión a tornillo 24VAC/DC TRS 24VUC 1CO (1122780000)	10u.	USD 32,69 IVA 21%
1122820000	TRS 230VUC 1CO	RELE BORNERA, conexión a tornillo 230VAC/DC (TRS 230VUC 1CO (1122820000)	10u.	USD 41,71 IVA 21%
1122850000	TRS 24-230VUC 1CO	RELE BORNERA, conexión a tornillo 24-230VAC/DC TRS 24-230VUC 1CO (1122850000)	10u.	USD 63,69 IVA 21%
2618000000	TRP 24VDC 1CO	RELE BORNERA, CONEXION PUSH IN TRP 24VDC 1CO (2618000000)	10u.	USD 12,85 IVA 21%
2663010000	TRP 24-230VUC 1CO ED2	RELE BORNERA, CONEXION PUSH IN TRP 24-230VUC 1CO ED2 (2663010000)	10u.	USD 84,24 IVA 21%
8937940000	MOS 24VDC/5-33VDC 10A	MICROOPTO, Rele de estado solido ideal electrovalculas, MOS 24VDC/5-33VDC 10A (8937940000)	1u.	USD 126,46 IVA 21%

## ACCESORIOS RELÉS INTERFASE TERM SERIES



CÓD. FABRICANTE	SKU	DESCRIPCIÓN	MASTER	PRECIO
2556360000	TCC 6.4/10 OR	PUENTE 10 polos NARANJA TCC 6.4/10 OR (2556360000)	10u.	USD 10,70 IVA 21%
2556440000	TCC 6.4/10 BL	PUENTE 10 polos AZUL TCC 6.4/10 BL (2556440000)	10u.	USD 11,07 IVA 21%
2556400000	TCC 6.4/10 RD	PUENTE 10 polos ROJO TCC 6.4/10 RD (2556400000)	10u.	USD 11,07 IVA 21%
2556370000	TCC 6.4/51 OR	PUENTE 51 polos NARANJA TCC 6.4/51 OR (2556370000)	10u.	USD 55,44 IVA 21%
2556410000	TCC 6.4/51 RD	PUENTE 51 polos ROJO TCC 6.4/51 RD (2556410000)	10u.	USD 55,44 IVA 21%
2556450000	TCC 6.4/51 BL	PUENTE 51 polos AZUL TCC 6.4/51 BL (2556450000)	10u.	USD 55,44 IVA 21%
1240800000	TW TXS/TXZ R3.2	SEPARADOR ROJO TW TXS/TXZ R3.2 p/relés (1240800000)	10u.	USD 3,95 IVA 21%

## SAFETY RELAYS

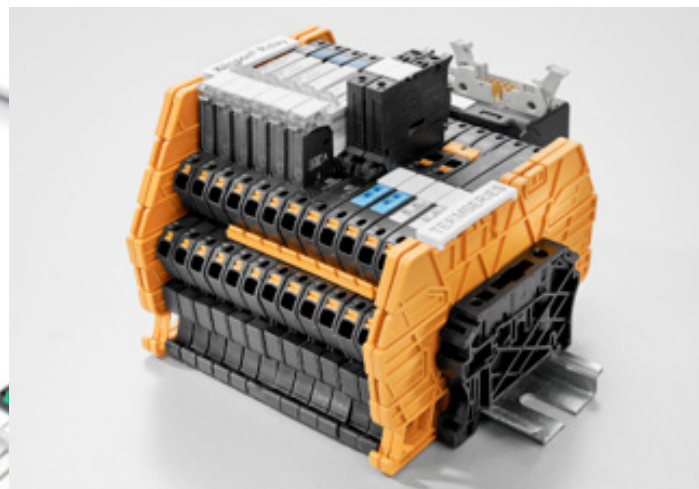

CÓD. FABRICANTE	SKU	DESCRIPCIÓN	MASTER	PRECIO
1319280000	SCS 24VDC P2SIL3ES	SAFESERIES, Relé de seguridad, SIL 3, SCS 24VDC P2SIL3ES (1319280000)	1u.	USD 499,11 IVA 21%



CÓD. FABRICANTE	SKU	DESCRIPCIÓN	MASTER	PRECIO
2636910000	VPU AC I 3+1 300/12.5 LCF	DESCARGADOR DE SOBRETENSIÓN, Baja tensión, Protector de sobretensión, TN-C-S, TN-S, TT, IT con N, IT sin N VPU AC I 3+1 300/12.5 LCF (2636910000)	1u.	USD 1.150,13 <small>IVA 21%</small>
2726770000	VPU AC I 3+1 R 275/25 LCF S 2PE	DESCARGADOR DE SOBRETENSIÓN, Baja tensión, Protector de sobretensión, TN-C-S, TN-S, TT, IT con N, IT sin N VPU AC I 3+1 300/12.5 LCF (2636910000)	1u.	USD 2.829,72 <small>IVA 21%</small>
2636930000	VPU AC I 1+1 300/12.5 LCF	DESCARGADOR DE SOBRETENSIÓN, Baja tensión, Protector de sobretensión, Monofásico, TN, TT, IT con N, IT sin N VPU AC I 1+1 300/12.5 LCF (2636930000)	1u.	USD 650,45 <small>IVA 21%</small>
2591070000	VPU AC II 1+1 R 300/50	DESCARGADOR DE SOBRETENSIÓN, Baja tensión, Protector de sobretensión, con contacto remoto, Monofásico, TN, TT, IT con N, IT sin N VPU AC II 1+1 R 300/50 (2591070000)	1u.	USD 238,14 <small>IVA 21%</small>
2591090000	VPU AC II 3+1 R 300/50	DESCARGADOR DE SOBRETENSIÓN, Baja tensión, Protector de sobretensión, con contacto remoto, TN-C-S, TN-S, TT, IT con N, IT sin N VPU AC II 3+1 R 300/50 (2591090000)	1u.	USD 359,06 <small>IVA 21%</small>
1351650000	VPU III R 230V/6KV AC	DESCARGADOR DE SOBRETENSIÓN, Baja tensión, con contacto remoto, Monofásico Tipo III, 230V (1351650000)	1u.	USD 192,78 <small>IVA 21%</small>
1351580000	VPU III R 24V/4KV AC/DC	DESCARGADOR DE SOBRETENSIÓN, Baja tensión, con contacto remoto, Monofásico Tipo III, 24V (1351580000)	1u.	USD 205,38 <small>IVA 21%</small>

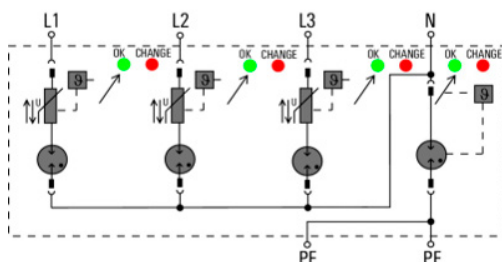

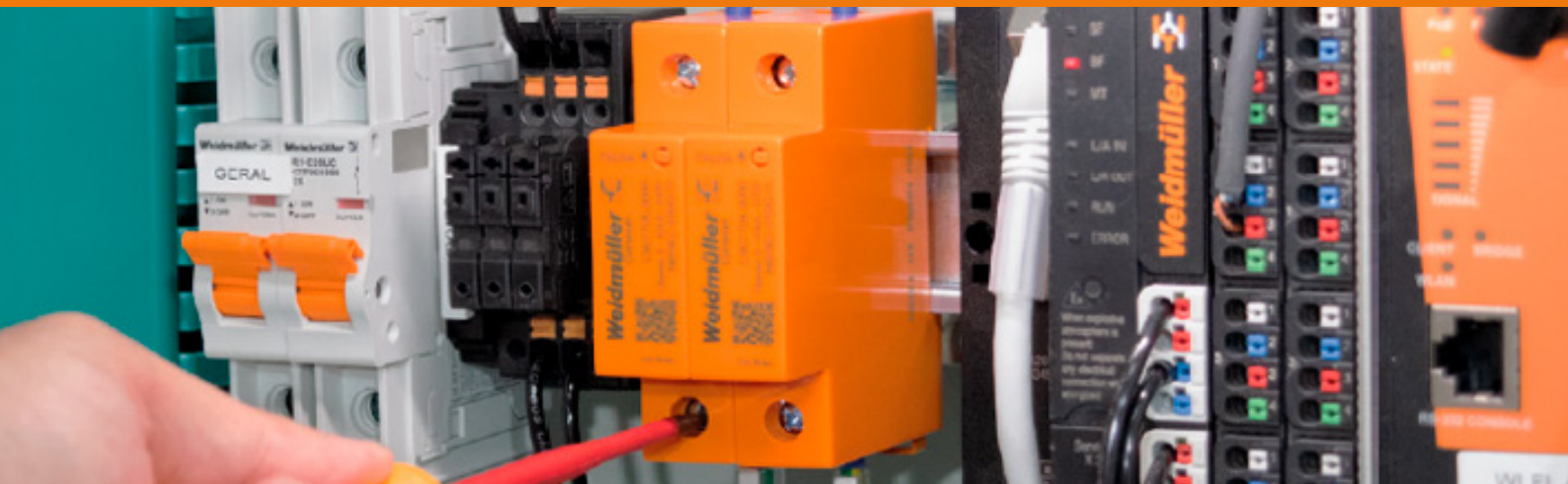

CÓD. FABRICANTE	SKU	DESCRIPCIÓN	MASTER	PRECIO
C907694.0000	DPS ECO POE RJ45 CAT6	DESCARGADOR DE SOBRETENSION Weidmüller Conexel ECO POE RJ45 CAT6 (C907694.0000)	10u.	USD 67,86 IVA 21%
C907701.0000	DPS ECO II 275V 20KA	DESCARGADOR DE SOBRETENSION Weidmüller Conexel ECO II 275V 20KA (C907701.0000)	10u.	USD 17,94 IVA 21%
C907702.0000	DPS ECO II 440V 20KA	DESCARGADOR DE SOBRETENSION Weidmüller Conexel ECO II 440V 20KA (C907702.0000)	10u.	USD 18,79 IVA 21%
C907704.0000	DPS ECO II 275V 40KA	DESCARGADOR DE SOBRETENSION Weidmüller Conexel ECO II 275V 40KA (C907704.0000)	10u.	USD 33,65 IVA 21%
C907698.00SR	DPS ECO II 275V 15KA CONT	DESCARGADOR DE SOBRETENSION Weidmüller Conexel ECO II 275V 40KA (C907704.0000)	10u.	USD 21,80 IVA 21%
C907704.00SR	DPS ECO II 275V 40KA CONT	DESCARGADOR DE SOBRETENSION Weidmüller Conexel ECO II 275V 40KA c/ señalización remota (C907704.00SR)	10u.	USD 41,35 IVA 21%





CÓD. FABRICANTE	SKU	DESCRIPCIÓN	MASTER	PRECIO
1481970000	ACT20P-PRO DCDC II-S	AMPLIFICADOR DE AISLAMIENTO ANALÓGICO, Fuente de alimentación 24...230 V AC/DC, Entrada : I/U universal, Salida : I/U universal (1481970000)	1u.	USD 1.005,82 IVA 21%
1176010000	ACT20M-AI-AO-E-S	AMPLIFICADOR DE AISLAMIENTO ANALÓGICO, configurable, sin alimentación de sensor, Entrada : I / U, Salida : I / U (1176010000)	1u.	USD 412,75 IVA 10.5%
1176020000	ACT20M-AI-2AO-S	SEPARADOR DE SEÑALES, configurable, con alimentación de sensor, Entrada : I / U, Salida : 2 x I/U (1176020000)	1u.	USD 696,71 IVA 10.5%
1375520000	ACT20M-RTI-AO-E-S	CONVERTIDORES DE SEÑALES DE TEMPERATURA, Sin separación galvánica, Entrada : Temperatura, PT100, Salida : I / U ACT20M-RTI-AO-E-S (1375520000)	1u.	USD 309,87 IVA 21%
8965440000	ACT20X-2HAI-2SAO-S	BARRERA/CONVERTIDOR DE SEÑAL Ex, HART®, 2 canales, Entrada ex: 4 - 20 mA, Salida segura: 4-20mA ACT20X-2HAI-2SAO-S (8965440000)	1u.	USD 1.018,78 IVA 21%
8965370000	ACT20X-2HDI-2SDO-RNO-S	BARRERA/CONVERTIDOR DE SEÑAL Ex, Entrada ex: sensor/interruptor NAMUR, Salida segura: relé, CNA, 2 canales ACT20X-2HDI-2SDO-RNO-S (8965370000)	1u.	USD 677,36 IVA 21%
7760054306	ACT20P-VM-AO-S	AMPLIFICADOR DE AISLAMIENTO ANALÓGICO, Entrada : Tensión AC/DC, 0...600 V DC, 0...440 V AC, Salida : 0-10 V, 0(4)-20 mA, CONVERTIDOR - SEPARADOR DE SEÑALES (7760054306)	1u.	USD 676,18 IVA 21%
8965490000	ACT20X-HUI-SAO-S	BARRERA/CONVERTIDOR DE SEÑAL Ex, Salida ex: U, I, R, Salida segura: relé 4-20mA/, 1 canal ACT20X-HUI-SAO-S (8965490000)	1u.	USD 927,88 IVA 21%
8978580000	CBX200 USB	CABLE PARA ACT20 CBX200 USB (8978580000)	1u.	USD 404,54 IVA 21%



# PRODUCTOS PARA EL INSTALADOR



CÓD. FABRICANTE	SKU	DESCRIPCIÓN	MASTER	PRECIO
C906996.0000	CARRO HERRAMIENTAS	CARRO VACÍO PARA HERRAMIENTAS Weidmüller Conexel h/250kg Made in Brasil (C906996.0000)	1u.	USD 2.351,58 <small>IVA 21%</small>

CORTAR



CÓD. FABRICANTE	SKU	DESCRIPCIÓN	MASTER	PRECIO
9002650000	KT 8	ALICATE KT 8 (9002650000)	1u.	USD 88,20 <small>IVA 21%</small>
2876450000	KT 8S	KT 8S (NUEVO, con resorte y bloqueo) (2876450000)	1u.	USD 106,35 <small>IVA 21%</small>
1157830000	KT 22	ALICATE KT 22 (1157830000)	1u.	USD 179,02 <small>IVA 21%</small>
2993490000	KT 40	ALICATE KT 40 (2993490000)	1u.	USD 768,65 <small>IVA 21%</small>
2993500000	KT 50	ALICATE KT 50 (2993500000)	1u.	USD 1.106,07 <small>IVA 21%</small>
9040130000	CUTTER 8	ALICATE REDLINE CUTTER 8 (9040130000)	1u.	USD 51,41 <small>IVA 21%</small>
9040140000	CUTTER 20 A	ALICATE REDLINE CUTTER 20 A (9040140000)	1u.	USD 90,72 <small>IVA 21%</small>
9040560000	CUTTER 35	ALICATE REDLINE CUTTER 35 c/ cremallera (9040560000)	1u.	USD 236,88 <small>IVA 21%</small>
9918700000	TSLD 5	Cortadora de Riel Din y barras de cobre TSLD 5 G32 (9918700000)	1u.	USD 8.449,16 <small>IVA 21%</small>



CÓD. FABRICANTE	SKU	DESCRIPCIÓN	MASTER	PRECIO
9046240000	STRIPPER 6	PELACABLES REDLINE STRIPPER 6 (9046240000)	1u.	USD 119,19 IVA 21%
9005000000	STRIPAX	PELACABLES STRIPAX (9005000000)	1u.	USD 160,04 IVA 21%
9005610000	STRIPAX 16	PELACABLES STRIPAX 16 (9005610000)	1u.	USD 369,4 IVA 21%
9020000000	STRIPAX PLUS 2.5	PELACABLES STRIPAX PLUS 2.5 corta/pela/crimpa (9020000000)	1u.	USD 699,36 IVA 21%
9204190000	AM 16	DESVAINADORA AM 16 (9204190000)	1u.	USD 229 IVA 21%
9001540000	AM 25	DESVAINADORA AM 25 (SINTENAX) (9001540000)	1u.	USD 89,96 IVA 21%
9030060000	AM 12	DESVAINADORA AM 12 (UTP) (9030060000)	1u.	USD 71,82 IVA 21%
2625720000	AM-X	PELACABLES DE POTENCIA AM-X Diámetro del conductor, máx.999 mm (2625720000)	1u.	USD 775,49 IVA 21%

STRIPAX PLUS





CÓD. FABRICANTE	SKU	DESCRIPCIÓN	MASTER	PRECIO
2903690000	PZ 2.5 S	CRIMPADORA Compacta PZ 2.5 S (2903690000)	1u.	USD 832,07 IVA 21%
9014350000	PZ 6 ROTO	HERRAMIENTA PARA PRENSAR, HERRAMIENTA PARA PRENSAR terminales tubulares, 0.14mm <sup>2</sup> , 6mm <sup>2</sup> , Crimpado trapecoidal PZ 6 ROTO (tubulares) (9014350000)	1u.	USD 243,18 IVA 21%
1445080000	PZ 10 SQR	CRIMPADORA PZ 10 Cuadrada (tubulares) (1445080000)	1u.	USD 691,42 IVA 21%
9012600000	PZ 16	HERRAMIENTA PARA PRENSAR, HERRAMIENTA PARA PRENSAR terminales tubulares, 6mm <sup>2</sup> , 16mm <sup>2</sup> , CRIMPADORA PZ 16 (tubulares) (9012600000)	1u.	USD 457,38 IVA 21%
9040530000	CRIMPER 6 Z	HERRAMIENTA REDLINE para prensar contactos, 0.5mm <sup>2</sup> , 6mm <sup>2</sup> , Crimpado trapecoidal CRIMPER 6 Z (tubulares) (9040530000)	1u.	USD 75,60 IVA 21%
9040540000	CRIMPER 16 Z	HERRAMIENTA REDLINE para prensar terminales tubulares, 6mm <sup>2</sup> , 16mm <sup>2</sup> , Crimpado trapecoidal CRIMPER 16 Z (tubulares) (9040540000)	1u.	USD 139,22 IVA 21%
9040470000	CRIMPER 25 Z	HERRAMIENTA REDLINE para prensar terminales tubulares, 6mm <sup>2</sup> , 25mm <sup>2</sup> , Crimpado trapecoidal CRIMPER 25 Z (tubulares) (9040470000)	1u.	USD 194,69 IVA 21%
9040450000	CRIMPER 6 I	HERRAMIENTA REDLINE para prensar contactos, 0.25mm <sup>2</sup> , 6mm <sup>2</sup> , Crimpado trapecoidal CRIMPER 6 I (ojal con ais.) (9040450000)	1u.	USD 90,72 IVA 21%
9006450000	PZ 50	CRIMPADORA hasta 50 mm <sup>2</sup> PZ 50 (9006450000)	1u.	USD 715,40 IVA 21%
9040490000	CRIMPER 6.3 F	HERRAMIENTA REDLINE para prensar contactos, 0.5mm <sup>2</sup> , 2.5mm <sup>2</sup> , Crimpado trapecoidal CRIMPER 6.3 F (faston) (9040490000)	1u.	USD 166,14 IVA 21%
9041650000	CRIMPER MOD 864	CRIMPADORA REDLINE CRIMPER 864 para ficha de red RJ45 (9041650000)	1u.	USD 278,16 IVA 21%

HERRAMIENTA HIDRÁULICA SACABOCADO CHAPA (H/3MM)



 [click para ir a la web del producto](#)



CÓD. FABRICANTE	SKU	DESCRIPCIÓN	MASTER	PRECIO
1966810000	IE-KO-HAT	PERFORADOR DE CHAPA IE-KO-HAT (1966810000)	1u.	<b>USD 4.144,14</b>
9204950000	KOS PG 13/M20	PERFORADOR DE CHAPA KOS PG 13/M20 (9204950000)	1u.	<b>USD 144,13</b> <small>IVA 10,5%</small>
9204900000	KOS-M25	PERFORADOR DE CHAPA KOS-M25 (9204900000)	1u.	<b>USD 191,86</b> <small>IVA 10,5%</small>
9204910000	KOS-M32	PERFORADOR DE CHAPA KOS-M25 (9204910000)	1u.	<b>USD 220,62</b> <small>IVA 10,5%</small>

HERRAMIENTAS RELACIONADAS



9918700000

CORTE RIEL DIN Y BARRA DE COBRE















1137530000









CORTE DE CABLECANAL

 [click para ir a la web del producto](#)

DESTORNILLADORES C/ AISLACIÓN VDE 1500 VDC 1000 VAC

	CÓD. FABRICANTE	SKU	DESCRIPCIÓN	MASTER	PRECIO
	2749130000	SDIL 0,5X3,0X100	DESTORNILLADOR 0,5x3,0x100 Plano 1000V (2749130000)	1u.	USD 13,99 IVA 21%
	2749140000	SDIL 0,6X3,5X100	DESTORNILLADOR 0,6x3,5x100 Plano 1000V (2749140000)	1u.	USD 15,32 IVA 21%
	2749150000	SDIL 0,8X4,0X100	DESTORNILLADOR 0,8x4,0x100 Plano 1000V (2749150000)	1u.	USD 16,51 IVA 21%
	2749160000	SDIL 1,0X5,5X125	DESTORNILLADOR 1,0x5,5x125 Plano 1000V (2749160000)	1u.	USD 25,20 IVA 21%
	2749170000	SDIL 1,2X6,5X150K	DESTORNILLADOR 1,2x6,5x150 Plano 1000V (2749170000)	1u.	USD 28,98 IVA 21%
	2749180000	SDIKL PH1X80	DESTORNILLADOR PH1 Phillips 1000V (2749180000)	1u.	USD 21,17 IVA 21%
	2749190000	SDIKL PH2X100K	DESTORNILLADOR PH2 Phillips 1000V (2749190000)	1u.	USD 26,84 IVA 21%
	2749120000	SDIL S 3-6,5/PH1/2	KIT 6 DESTORNILLADORES 1000V SDIL S 3-6,5/PH1/2 (2749120000)	1u.	USD 115,92 IVA 21%
	2749750000	SDI SET S2.5-5.5/PH1/2	KIT 6 DESTORNILLADORES 1000V S 2,5-5,5 PH 1-2 (2749750000)	1u.	USD 118,44 IVA 21%
	2749200000	SD SET S2.5-5.5/PH1/2	Kit x 6 DESTORNILLADORES estándar S 2,5-5,5 PH 1-2 (2749200000)	1u.	USD 109,62 IVA 21%
	9006060000	SWIFTY SET	DESTORNILLADOR c/ herramienta de corte SWIFTY SET (9006060000)	1u.	USD 78,12 IVA 21%
	2749340000	SDS 0.6X3.5X100	DESTORNILLADOR 0.6X3.5X100 Plano (solo DESTORNILLADOR) (2749340000)	1u.	USD 14,87 IVA 21%
	9006020000	SWIFTY	SWIFTY (solo accesorio de corte para DESTORNILLADORES) (9006020000)	1u.	USD 59,65 IVA 21%

DESTORNILLADORES ESPECIALES / TORQUIMETROS

	CÓD. FABRICANTE	SKU	DESCRIPCIÓN	MASTER	PRECIO
	9918370000	DMS MANUELL 0,5-1,7	MANGO TORQUÍMETRO 0,5-1,7Nm (9918370000)	1u.	USD 505,7 IVA 21%
	9918380000	DMS MANUELL 2,0-7,0	MANGO TORQUÍMETRO 2-8Nm (9918380000)	1u.	USD 597,24 IVA 21%
	2748110000	BIT-BOX 11	KIT de 8 puntas 1/4" (plano y phillips) (2748110000)	1u.	USD 81,48 IVA 21%
	9918520000	WK S 0,4X2,5	Caña p/ torquímetro, tornillo plano 0,4 x 2,5 mm (9918520000)	1u.	USD 18,42 IVA 21%
	9918530000	WK S 0,5X3,0	Caña p/ torquímetro, tornillo plano 0,6 x 3,5 mm (9918530000)	1u.	USD 19 IVA 21%
	9918540000	WK S 0,6X3,5	Caña p/ torquímetro, tornillo plano 0,6 x 3,5 mm (9918540000)	1u.	USD 16,01 IVA 21%
	9918550000	WK S 0,8X4,0	Caña p/ torquímetro, tornillo plano 0,8 X 4 mm (9918550000)	1u.	USD 19 IVA 21%
	9918560000	WK S 1,0X5,5	Caña p/ torquímetro, tornillo plano 1 x 5,5 mm (9918560000)	1u.	USD 18,46 IVA 21%
	9918580000	WK K PH1	Caña p/ torquímetro, tornillo Phillips 1 (9918580000)	1u.	USD 18,99 IVA 21%
	9918590000	WK K PH2	Caña p/ torquímetro, tornillo Phillips 1 (9918580000)	1u.	USD 18,99 IVA 21%

PINZAS Y ALICATES

	CÓD. FABRICANTE	SKU	DESCRIPCIÓN	MASTER	PRECIO
	9046290000	KBZ 180	Pinza Universal Aislacion 1kV (9046290000)	1u.	USD 87,3 IVA 21%
	9046320000	SE HD 160	ALICATE Aislacion 1kV (9046320000)	1u.	USD 87,3 IVA 21%
	9046370000	FRZ S 160	PINZA DE PUNTA AISLACION 1KV (9046370000)	1u.	USD 85,85 IVA 21%
	9046440000	AIZ 160	AIZ 160 Tenaza pelacables Aislacion 1KV (9046440000)	1u.	USD 108,21 IVA 21%

LLAVES



CÓD. FABRICANTE	SKU	DESCRIPCIÓN	MASTER	PRECIO
9918130000	CROSS-KEY UNIVERSAL	LLAVE UNIVERSAL PARA APERTURA DE TABLEROS CROSS-KEY UNIVERSAL REDLINE (9918130000)	1u.	USD 48,03 <small>IVA 21%</small>



9008850000	SK WSD-S 1,5-10,0	JUEGO DE 9 llaves Allen con cabeza hexagonal y soporte (9008850000)	1u.	USD 113,4 <small>IVA 21%</small>
------------	-------------------	--	-----	-------------------------------------



9008860000	SKS 2,0-8,0	JUEGO DE 7 llaves Allen tipo navaja 2/2.5/3/4/5/6/8 (9008860000)	1u.	USD 66,78 <small>IVA 21%</small>
------------	-------------	---	-----	-------------------------------------

COMPROBADORES DE TENSIÓN / INSTRUMENTOS



CÓD. FABRICANTE	SKU	DESCRIPCIÓN	MASTER	PRECIO
2436670000	VT LCL	Comprobador de tension 12-1000 VAC s/contacto c/luz (2436670000)	1u.	USD 101,26 <small>IVA 21%</small>



9918950000	VT	Punta de prueba Volt-Check 3.1 / 6 - 400 AC/DC (no necesita pilas) (9918950000)	1u.	USD 54,03 <small>IVA 10.5%</small>
------------	----	--	-----	---------------------------------------



9427300000	TEMPHASER	Multímetro con rango automático (9427300000)	1u.	USD 397,33 <small>IVA 21%</small>
------------	-----------	--	-----	--------------------------------------



9427460000	MG KIT CA 600	Kit Multímetro + Amperométrica 600 Amperes (9427460000)	1u.	USD 938,4 <small>IVA 21%</small>
------------	---------------	---	-----	-------------------------------------

VALIJAS ULTRA RESISTENTES CON BASE PLÁSTICA



CÓD. FABRICANTE	SKU	DESCRIPCIÓN	MASTER	PRECIO
9202470000	PRO CASE LEER	Maleta PRO CASE VACIA (TELA) (9202470000)	1u.	USD 472,08 <small>IVA 21%</small>



1345330000	TOP CASE	Maleta TOP CASE CON RUEDAS (VACIA) (1345330000)	1u.	USD 1.148,28 <small>IVA 21%</small>
------------	----------	---	-----	--



CÓD. FABRICANTE	SKU	DESCRIPCIÓN	MASTER	PRECIO
2599430000	THM MULTIMARK	IMPRESORA THM Multimark (2599430000)	1u.	<b>USD 3.743,61</b> IVA 10,5%



1331600000	THM MMP CUTTER	Modulo de corte para THM (1331600000)	1u.	<b>USD 1.148,28</b> IVA 10,5%
------------	----------------	---------------------------------------	-----	----------------------------------



1416330000	THM MMP PERFORATOR	Modulo troquelador para THM (1416330000)	1u.	<b>USD 2.267,18</b> IVA 10,5%
------------	--------------------	--	-----	----------------------------------

## RIBBONS



CÓD. FABRICANTE	SKU	DESCRIPCIÓN	MASTER	PRECIO
2005080000	MM 76/360 SW	RIBBON MM 76/360 SW (2005080000)	1u.	<b>USD 465,78</b> IVA 21%



2005070000	MM 110/360 SW	RIBBON MM 110/360 SW (2005070000)	1u.	<b>USD 465,81</b> IVA 21%
------------	---------------	-----------------------------------	-----	------------------------------



2005040000	MM 84/300 WS	RIBBON MM 84/300 WS (2005040000)	1u.	<b>USD 1.163,94</b> IVA 21%
------------	--------------	----------------------------------	-----	--------------------------------



1426210000	HSS HF EL 40/300	RIBBON HSS HF EL 40/300 (1426210000)	1u.	<b>USD 427,25</b> IVA 21%
------------	------------------	--------------------------------------	-----	------------------------------



2005090000	MM-TB 25/360 SW	RIBBON MM-TB 25/360 SW (2005090000)	1u.	<b>USD 116,47</b> IVA 21%
------------	-----------------	-------------------------------------	-----	------------------------------

TERMOCONTRAIBLES PARA IDENTIFICACIÓN DE CABLES

BLANCOS



CÓD. FABRICANTE	SKU	DESCRIPCIÓN	MASTER	PRECIO
1423330000	HSS-HF 1.2-2.4 EL W13M	TERMOCONTRAIBLE PARA CABLES Y CONDUCTORES, 1.2 - 2.4 mm, BLANCO HSS-HF 1.2-2.4 EL W13M (1423330000)	1u.	USD 97,09 IVA 21%
1423340000	HSS-HF 1.6-3.2 EL W13M	TERMOCONTRAIBLE PARA CABLES Y CONDUCTORES, 1.6 - 3.2 mm, BLANCO HSS-HF 1.6-3.2 EL W13M (1423340000)	1u.	USD 102,81 IVA 21%
1423350000	HSS-HF 2.4-4.8 EL W13M	TERMOCONTRAIBLE PARA CABLES Y CONDUCTORES, 2.4 - 4.8 mm, BLANCO HSS-HF 2.4-4.8 EL W13M (1423350000)	1u.	USD 137,96 IVA 21%
1423360000	HSS-HF 3.2-6.4 EL W13M	TERMOCONTRAIBLE PARA CABLES Y CONDUCTORES, 3.2 - 6.4 mm, BLANCO HSS-HF 3.2-6.4 EL W13M (1423360000)	1u.	USD 167,06 IVA 21%
1423370000	HSS-HF 4.8-9.5 EL W13M	TERMOCONTRAIBLE PARA CABLES Y CONDUCTORES, 4.8 - 9.5 mm, BLANCO HSS-HF 4.8-9.5 EL W13M (1423370000)	1u.	USD 228,37 IVA 21%



1423380000	HSS-HF 6.4-12.7 EL W13M	TERMOCONTRAIBLE PARA CABLES Y CONDUCTORES, 6.4 - 12.7 mm, BLANCO HSS-HF 6.4-12.7 EL W13M (1423380000)	1u.	USD 227,96 IVA 21%
1423390000	HSS-HF 9.5-19.1 EL W10M	TERMOCONTRAIBLE PARA CABLES Y CONDUCTORES, 9.5 - 19.1 mm, BLANCO HSS-HF 9.5-19.1 EL W10M (1423390000)	1u.	USD 249,04 IVA 21%
1423410000	HSS-HF 12.7-25.4 EL W10M	TERMOCONTRAIBLE PARA CABLES Y CONDUCTORES, 12.7 - 25.4 mm, BLANCO HSS-HF 12.7-25.4 EL W10M (1423410000)	1u.	USD 434,83 IVA 21%

AMARILLOS



CÓD. FABRICANTE	SKU	DESCRIPCIÓN	MASTER	PRECIO
1423220000	HSS-HF 1.2-2.4 EL Y13M	TERMOCONTRAIBLE PARA CABLES Y CONDUCTORES, 1.2 - 2.4 mm, AMARILLO HSS-HF 1.2-2.4 EL Y13M (1423220000)	1u.	USD 119,54 IVA 21%
1423240000	HSS-HF 2.4-4.8 EL Y13M	TERMOCONTRAIBLE PARA CABLES Y CONDUCTORES, 2.4 - 4.8 mm, AMARILLO HSS-HF 2.4-4.8 EL Y13M (1423240000)	1u.	USD 119,9 IVA 21%
1423260000	HSS-HF 4.8-9.5 EL Y13M	TERMOCONTRAIBLE PARA CABLES Y CONDUCTORES, 4.8 - 9.5 mm, AMARILLO HSS-HF 4.8-9.5 EL Y13M (1423260000)	1u.	USD 244,11 IVA 21%
1423270000	HSS-HF 6.4-12.7 EL Y13M	TERMOCONTRAIBLE PARA CABLES Y CONDUCTORES, 6.4 - 12.7 mm, AMARILLO HSS-HF 6.4-12.7 EL Y13M (1423270000)	1u.	USD 227,95 IVA 21%



IDENTIFICADORES PARA BORNES



PARA WEIDMUELLER



CÓD. FABRICANTE	SKU	DESCRIPCIÓN	MASTER	PRECIO
2007110000	DEK 5/5 MM WS	ROTULO P-BORNES Weidmuller DEK 5/5 MM WS 800 u. (1 rollo) (2007110000)	800u.	USD 0,16 IVA 21%
2007120000	DEK 5/6 MM WS	ROTULO P-BORNES Weidmuller DEK 5/6 MM WS insercion continua SAK 2,5 600 u. (1 rollo) (2007120000)	600u.	USD 0,08 IVA 21%
2007130000	DEK 5/8 MM WS	ROTULO P-BORNES Weidmuller DEK 5/8 MM WS insercion continua SAK 4 500 u. (1 rollo) (2007130000)	500u.	USD 0,08 IVA 21%
2007150000	WS 8/5 MM WS	ROTULO P-BORNES Weidmuller WS 8/5 MM WS 800 u. (1 rollo) (2007150000)	800u.	USD 0,08 IVA 21%

PARA OTRAS MARCAS



CÓD. FABRICANTE	SKU	DESCRIPCIÓN	MASTER	PRECIO
2519200000	MF 5/5 MM WS	ROTULO DE BORNES MULTIFIT apto PxC MF 5/5 MM WS (2519200000)	1200u.	USD 0,31 IVA 21%
2519210000	MF 5/6 MM WS	ROTULO DE BORNES MULTIFIT apto PxC MF 5/6 MM WS (2519210000)	1000u.	USD 0,31 IVA 21%
2519170000	MF 10/5 MM WS	ROTULO DE BORNES MULTIFIT apto PxC MF 10/5 MM WS (2519170000)	600u.	USD 0,31 IVA 21%
2519180000	MF 10/6 MM WS	ROTULO DE BORNES MULTIFIT apto PxC MF 10/6 MM WS (2519180000)	500u.	USD 0,35 IVA 21%
2519190000	MF 10/8 MM WS	ROTULO DE BORNES MULTIFIT apto PxC MF 10/8 MM WS (2519190000)	400u.	USD 0,35 IVA 21%
2518500000	MF 8/5 MM WS	ROTULO BORNES Multifit apto PxC MF 8/5 MM WS (2518500000)	600u.	USD 0,35 IVA 21%
2518600000	THM MMP ROLLER MF	Rodillo de impresion para utilizar MF en la THM MMP ROLLER MF (2518600000)	1u.	USD 475,16 IVA 10,5%



IDENTIFICADORES PARA TOPES WEW Y ZEW 35 Y SERIE A



CÓD. FABRICANTE	SKU	DESCRIPCIÓN	MASTER	PRECIO
2009980000	ELS 6/30 MM WS	ELS 6/30 Etiqueta para Impresora THM (2009980000)	3000u.	USD 0,39 IVA 21%
1806120000	EM 8/30	EM 8/30 Accesorio para tope final WEW 35/2 (1806120000)	50u.	USD 0,98 IVA 21%

RÓTULOS UNIVERSALES PARA CABLES Y CAÑOS



CÓD. FABRICANTE	SKU	DESCRIPCIÓN	MASTER	PRECIO
1774350000	THM WO 25/76 WS	THM, Señalizadores para cables y conductores, 4.8 - 19.4 mm, 25 x 76 mm, BLANCO (1774350000)	1u.	USD 462,78 IVA 21%

RÓTULOS PARA IDENTIFICACIÓN DE CABLES



CÓD. FABRICANTE	SKU	DESCRIPCIÓN	MASTER	PRECIO
2005450000	TM-I 15 MM WS	TM-I, Señalizadores CONECTORes, 1.3 - 35 mm, 15 x 4 mm, BLANCO (2005450000)	2000u.	USD 0,24 <small>IVA 21%</small>
1798620000	TM 201/15 V0	TM, Manguito x 5 mm, PVC, Color: transparente, diámetro externo del conductor: 1.5 - 2.5 mm TM 201/15 V0 (1798620000)	1000u.	USD 0,12 <small>IVA 21%</small>
1798540000	TM 202/15 V0	TM, Manguito x 5 mm, PVC, Color: transparente, diámetro externo del conductor: 2 - 4 mm TM 202/15 V0 (1798540000)	1000u.	USD 0,12 <small>IVA 21%</small>
1798490000	TM 203/15 V0	TM, Manguito x 9 mm, PVC, Color: transparente, diámetro externo del conductor: 4 - 6 mm TM 203/15 V0 (1798490000)	500u.	USD 0,16 <small>IVA 21%</small>
1806240000	TM 204/15 V0	TM, Manguito x 14 mm, PVC, Color: transparente, diámetro externo del conductor: 6 - 10 mm TM 204/15 V0 (1806240000)	500u.	USD 0,19 <small>IVA 21%</small>
1806250000	TM 205/15 V0	TM, Manguito x 18 mm, PVC, Color: transparente, diámetro externo del conductor: 10 - 14 mm TM 205/15 V0 (1806250000)	200u.	USD 0,31 <small>IVA 21%</small>
1806260000	TM 206/15 V0	TM, Manguito x 27 mm, PVC, Color: transparente, diámetro externo del conductor: 14 - 22 mm TM 206/15 V0 (1806260000)	200u.	USD 0,72 <small>IVA 21%</small>
1866680000	TMX 30 V0	TM, Manguito x 20 mm, PVC, Color: transparente, diámetro externo del conductor: 10 - 317 mm TMX 30 V0 (1866680000)	400u.	USD 1,42 <small>IVA 21%</small>

MARCO PORTA RÓTULO PARA IDENTIFICAR CABLES

CÓD. FABRICANTE	SKU	DESCRIPCIÓN	MASTER	PRECIO
2009980000	ELS 6/30 MM WS	ELS 6/30 Etiqueta para Impresora THM (2009980000)	3000u.	USD 0,39 <small>IVA 21%</small>
2005180000	ELS 8/20 MM WS	ELS, Señalizadores CONECTORes, 7 - 115 mm, 20 x 8 mm, BLANCO (2005180000)	3000u.	USD 0,37 <small>IVA 21%</small>
2005200000	ELS 16/40 MM WS	ELS, Señalizadores CONECTORes, 7 - 115 mm, 40 x 16 mm, BLANCO (2005200000)	2000u.	USD 0,52 <small>IVA 21%</small>
1631910000	WKM 8/30	WKM, Señalizadores para cables y conductores, 7-115 mm, 30 x 8 mm, transparente WKM 8/30 (1631910000)	50u.	USD 0,27 <small>IVA 21%</small>
1753490000	WKM 8/20	WKM, Señalizadores para cables y conductores, 7 - 115 mm, 20 x 8 mm, transparente (1753490000)	50u.	USD 0,24 <small>IVA 21%</small>
1610700000	WKM 18/43	WKM, Señalizadores para cables y conductores, 7 - 115 mm, 43 x 18 mm, transparente WKM 18/43 (1610700000)	50u.	USD 0,33 <small>IVA 21%</small>



## MARCADORES PARA PRECINTAR EN CABLES



CÓD. FABRICANTE	SKU	DESCRIPCIÓN	MASTER	PRECIO
2005380000	SFX 9/24 MM GE	SLIMFIX, Señalizadores para cables y conductores, 7 -, 26 x 15 mm, AMARILLO (2005380000)	1000u.	USD 0,62 <small>IVA 21%</small>
2005400000	SFX 11/60 MM GE	SLIMFIX, Señalizadores para cables y conductores, 7 -, 60 x 13 mm, AMARILLO (2005400000)	1000u.	USD 1,02 <small>IVA 21%</small>
2005420000	SFX 30/60 MM GE	SLIMFIX, Señalizadores para cables y conductores, 7 -, 60 x 32 mm, AMARILLO (2005420000)	300u.	USD 1,67 <small>IVA 21%</small>

## ETIQUETAS PARA BOTONERAS Y PILOTOS



CÓD. FABRICANTE	SKU	DESCRIPCIÓN	MASTER	PRECIO
2005840000	SM 27/18-22 MM WS	SwitchMark, Señalizadores de dispositivos, 47.75 x 27 mm, BLANCO (para botonera M22) (2005840000)	1000u.	USD 1,74 <small>IVA 21%</small>
2006060000	SM DIA 60-22 MM GE	SwitchMark, Señalizadores de dispositivos Emergencia, AMARILLO (2006060000)	450u.	USD 2,49 <small>IVA 21%</small>

ETIQUETAS PARA COMPONENTES DE TABLEROS, EQUIPOS Y USO GENERAL

	CÓD. FABRICANTE	SKU	DESCRIPCIÓN	MASTER	PRECIO
	1753231044	THM MT30X 15/6 WS	THM, Señalizadores de dispositivos, 6 x 15 mm, BLANCO (1753231044)	1u.	USD 557,44 IVA 21%
	2712050000	THM MT30X 17/8 WS	THM, Señalizadores de dispositivos, 8 x 17 mm, BLANCO THM MT30X 17/8 WS (2712050000)	0u.	USD 0,1 IVA 21%
	1751761044	THM MT30X 26/10 WS	THM, Señalizadores de dispositivos, 10 x 26 mm, BLANCO (1751761044)	1u.	USD 557,65 IVA 21%
	1751831044	THM MT30X 65/35 WS	THM, Señalizadores de dispositivos, 35 x 65 mm, BLANCO (1751831044)	1u.	USD 557,52 IVA 21%
	1072690000	THM MT30X 15/4 GE	Señalizadores de dispositivos, 4 x 15 mm, AMARILLO THM MT30X 15/4 GE (amarilla) (1072690000)	1u.	USD 557,43 IVA 21%
	1753241687	THM MT30X 20/8 GE	THM, Señalizadores de dispositivos, 8 x 20 mm, AMARILLO (1753241687)	1u.	USD 557,55 IVA 21%
	1778170000	THM MT30x 101/150 SI/G	THM MT30X 101/150 SI/G Etiqueta GRIS Plata 101 x 150mm (1778170000)	1u.	USD 557,72 IVA 21%
	2006640000	EL 27 MM GE 30M	ROLLO CONTINUO AMARILLO-EL 27 MM GE 30M (2006640000)	1u.	USD 330,34 IVA 21%
	2519010000	EL 38 MM BL 30M	ETIQUETA CONTINUA THM, Señalizadores de dispositivos, 38 x , AZUL EL 38 MM BL 30M (2519010000)	1u.	USD 657,95 IVA 21%
	2006670000	EL 38 MM GE 30M	ROLLO CONTINUO AMARILLO-EL 38 MM GE 30M (2006670000)	1u.	USD 464,97 IVA 21%
	2006660000	EL 38 MM WS 30M	ROLLO CONTINUO BLANCO - EL 38 MM WS 30M (2006660000)	1u.	USD 464,97 IVA 21%
	2528410000	EL 38 MM SW 30M	ETIQUETA CONTINUA THM, Señalizadores de dispositivos, 38 x , NEGRA EL 38 MM SW 30M (2528410000)	1u.	USD 657,95 IVA 21%
	2006650000	EL 38 MM SI 30M	ROLLO CONTINUO GRIS - EL 38 MM SI 30M (2006650000)	1u.	USD 465 IVA 21%
	2006700000	EL 60 MM GE 30M	ROLLO CONTINUO AMARILLO-EL 60 MM GE 30M (2006700000)	1u.	USD 1.034,58 IVA 21%
	2006730000	EL 100 MM GE 30M	ROLLO CONTINUO AMARILLO-EL 100 MM GE 30M (2006730000)	1u.	USD 1.218,54 IVA 21%

PRENSACABLES IP68 PLÁSTICOS (POLIAMIDA 6,6)



CÓD. FABRICANTE	SKU	DESCRIPCIÓN	MASTER	PRECIO
1772280000	VG M12-1/K68	PRENSACABLE - VG M12-1/K68 (1772280000)	100u.	USD 2,03 IVA 21%
1772290000	VG M16 - K 68	PRENSACABLE - VG M16 - K 68 (1772290000)	50u.	USD 2,04 IVA 21%
1772300000	VG M20-1/K68	PRENSACABLE - VG M20-1/K68 (1772300000)	100u.	USD 2,39 IVA 21%
1909870000	VG M25-1/K68	PRENSACABLE Plastico- VG M25-1/K68 (1909870000)	50u.	USD 3,92 IVA 21%
1909880000	VG M32-1/K68	PRENSACABLE Plastico- VG M32-1/K68 (1909880000)	100u.	USD 8,33 IVA 21%
1909890000	VG M40-1/K68	PRENSACABLE Plastico- VG M40-1/K68 (1909890000)	10u.	USD 13,2 IVA 21%
1909740000	VG M50-K67	PRENSACABLE Plastico- VG M50-K67 (1909740000)	450u.	USD 21,65 IVA 21%

CONTRATUERCA PLÁSTICA



CÓD. FABRICANTE	SKU	DESCRIPCIÓN	MASTER	PRECIO
1772440000	SKMU M12 - K GR	TUERCA PA - SKMU M12 - K GR (1772440000)	100u.	USD 0,45 IVA 21%
1772450000	SKMU M16 - K GR	TUERCA PA - SKMU M16 - K GR (1772450000)	100u.	USD 0,50 IVA 21%
1772460000	SKMU M20 - K GR	TUERCA PA - SKMU M20 - K GR (1772460000)	100u.	USD 0,70 IVA 21%
1772470000	SKMU M25 - K GR	TUERCA PA - SKMU M25 - K GR (1772470000)	100u.	USD 0,80 IVA 21%
1772480000	SKMU M32 - K GR	TUERCA PA - SKMU M32 - K GR (1772480000)	100u.	USD 1,2 IVA 21%
1772490000	SKMU M40 - K GR	TUERCA PA - SKMU M40 - K GR (1772490000)	50u.	USD 2,87 IVA 21%
1772500000	SKMU M50 - K GR	TUERCA PA - SKMU M50 - K GR (1772500000)	10u.	USD 4,43 IVA 21%

METÁLICO IP68 LATON NIQUELADO



CÓD. FABRICANTE	SKU	DESCRIPCIÓN	MASTER	PRECIO
1772200000	VG M12 - MS 68	PRENSACABLE - VG M12 - MS 68 (1772200000)	50u.	USD 8,13 IVA 21%
1909910000	VG M16-1/MS68	PRENSACABLE laton - VG M16-1/MS68 (1909910000)	50u.	USD 8,45 IVA 21%
1772220000	VG M20 - MS 68	PRENSACABLE - VG M20 - MS 68 (1772220000)	50u.	USD 12,52 IVA 21%
1909920000	VG M25-1/MS68	PRENSACABLE laton - VG M25-1/MS68 (1909920000)	25u.	USD 13,96 IVA 21%
1909930000	VG M32-1/MS68	PRENSACABLE laton - VG M32-1/MS68 (1909930000)	10u.	USD 23,29 IVA 21%
1909940000	VG M40-1/MS68	PRENSACABLE laton - VG M40-1/MS68 (1909940000)	10u.	USD 27,85 IVA 21%
1909950000	VG M50-1/MS68	PRENSACABLE laton - VG M50-1/MS68 (1909950000)	5u.	USD 74,86 IVA 21%

CONTRATUERCA METÁLICA



CÓD. FABRICANTE	SKU	DESCRIPCIÓN	MASTER	PRECIO
1772360000	SKMU M12 MS	TUERCA Laton - SKMU M12 MS (1772360000)	100u.	USD 1,16 <small>IVA 21%</small>
1736990000	SKMU M16 MS	TUERCA Laton M16 SKMU M16 MS (1736990000)	100u.	USD 1,49 <small>IVA 21%</small>
1737000000	SKMU M20 MS	TUERCA Laton M20 SKMU M20 MS (1737000000)	100u.	USD 1,68 <small>IVA 21%</small>
1737010000	SKMU M25 MS	TUERCA Laton M25 SKMU M25 MS (1737010000)	100u.	USD 2,3 <small>IVA 21%</small>
1737020000	SKMU M32 MS	TUERCA Laton M32 SKMU M32 MS (1737020000)	100u.	USD 3,56 <small>IVA 21%</small>
1737030000	SKMU M40 MS	TUERCA Laton M40 SKMU M40 MS (1737030000)	50u.	USD 6,57 <small>IVA 21%</small>
1737040000	SKMU M50 MS	TUERCA Laton M50 SKMU M50 MS (1737040000)	25u.	USD 12,86 <small>IVA 21%</small>

PUNTERA PREAISLADA SIMPLE (FERRULES)



CÓD. FABRICANTE	SKU	DESCRIPCIÓN	MASTER	PRECIO
9019010000	H0,5/14D W	PUNTERA PREAISLADA, p/ 0,5mm2 BLANCO - H0,5/14D (9019010000)	500u.	USD 0,03 <small>IVA 21%</small>
9019040000	H0,75/14D GR	PUNTERA PREAISLADA, p/ 0,75mm2 GRIS - H0,75/14D (9019040000)	500u.	USD 0,03 <small>IVA 21%</small>
9019080000	H1,0/14D R	PUNTERA PREAISLADA, p/ 1mm2 ROJO - H1,0/14D (9019080000)	500u.	USD 0,03 <small>IVA 21%</small>
9019120000	H1,5/14D SW	PUNTERA PREAISLADA, p/ 1,5mm2 NEGRO - H1,5/14D (9019120000)	500u.	USD 0,03 <small>IVA 21%</small>
9019160000	H2,5/15D BL	PUNTERA PREAISLADA, p/ 2,5mm2 AZUL - H2,5/15D (9019160000)	500u.	USD 0,06 <small>IVA 21%</small>
9019200000	H4,0/20D GR	PUNTERA PREAISLADA, p/ 4mm2 GRIS - H4,0/20D (9019200000)	500u.	USD 0,11 <small>IVA 21%</small>
9019220000	H6,0/20D GE	PUNTERA PREAISLADA, p/ 6mm2 AMARILLO - H6,0/20D (9019220000)	100u.	USD 0,13 <small>IVA 21%</small>
9019240000	H10,0/22D R	PUNTERA PREAISLADA, p/ 10mm2 ROJO - H10,0/22D (9019240000)	100u.	USD 0,13 <small>IVA 21%</small>
9019260000	H16,0/22D BL	PUNTERA PREAISLADA, p/ 16mm2 AZUL - H16,0/22D (9019260000)	100u.	USD 0,18 <small>IVA 21%</small>
9019280000	H25,0/30D 16 GE	PUNTERA PREAISLADA, p/ 25mm2 AMARILLO - H25,0/30D (9019280000)	50u.	USD 0,42 <small>IVA 21%</small>
9019310000	H35,0/30D 16 R	PUNTERA PREAISLADA, p/ 35mm2 ROJO - H35,0/30D (9019310000)	50u.	USD 0,62 <small>IVA 21%</small>
9019340000	H50,0/36D BL	PUNTERA PREAISLADA, p/ 50mm2 AZUL - H50,0/36D (9019340000)	50u.	USD 0,9 <small>IVA 21%</small>

PUNTERA HUECA PREAISLADA DOBLE (FERRULES)



CÓD. FABRICANTE	SKU	DESCRIPCIÓN	MASTER	PRECIO
	9037380000	H0,5/14D ZH W PUNTERA DOBLE PREAISLADA, BLANCO p/0,5 - H0,5/14D (9037380000)	500u.	USD 0,11 IVA 21%
	9037410000	H0,75/14D ZH GR PUNTERA DOBLE PREAISLADA, GRIS p/0,75 - H0,75/14D (9037410000)	500u.	USD 0,09 IVA 21%
	9037440000	H1,0/15D ZH R PUNTERA DOBLE PREAISLADA, ROJO p/1 - H1,0/15D (9037440000)	500u.	USD 0,11 IVA 21%
	9037470000	H1,5/16D ZH SW PUNTERA DOBLE PREAISLADA, NEGRO p/1,5 - H1,5/16D (9037470000)	500u.	USD 0,09 IVA 21%
	9037500000	H2,5/19D ZH BL PUNTERA DOBLE PREAISLADA, BLANCO p/2,5 - H2,5/19D (9037500000)	500u.	USD 0,11 IVA 21%
	9037530000	H4,0/22D ZH GR PUNTERA DOBLE PREAISLADA, GRIS p/4 - H4,0/22D (9037530000)	100u.	USD 0,3 IVA 21%
	9037550000	H6,0/23D ZH GE PUNTERA DOBLE PREAISLADA, AMARILLO p/6 - H6,0/23D (9037550000)	100u.	USD 0,45 IVA 21%
	9037570000	H10,0/24D ZH R PUNTERA DOBLE PREAISLADA, ROJO p/10 - H10,0/24D (9037570000)	100u.	USD 0,56 IVA 21%
	9037590000	H16,0/29D ZH BL PUNTERA DOBLE PREAISLADA, AZUL p/16 - H16,0/29D (9037590000)	50u.	USD 0,67 IVA 21%



# CONECTORES CIRCULARES Y RECTANGULARES

FICHA CON SALIDA SUPERIOR



CÓD. FABRICANTE	SKU	DESCRIPCIÓN	MASTER	PRECIO
1788820000	HDC 04A TOLU 1M20G	CAPOTA TAMAÑO 1 enclavamiento lateral HDC-04A-TOLU-1M20G 3/4 polos (1788820000)	1u.	USD 10,43 <small>IVA 21%</small>
1788120000	HDC 06B TOLU 1M20G	CAPOTA TAMAÑO 3 enclavamiento longitudinal HDC-06B-TOLU-1M20G 6 polos (1788120000)	1u.	USD 19,22 <small>IVA 21%</small>
1787590000	HDC 10B TOBU 1M25G	CAPOTA TAMAÑO 4 enclavamiento lateral HDC-10B-TOBU-1M25G 10 polos (1787590000)	1u.	USD 24,68 <small>IVA 21%</small>
1788210000	HDC 16B TOBU 1M25G	CAPOTA TAMAÑO 6 enclavamiento lateral HDC-16B-TOBU-1M25G 16 polos (1788210000)	1u.	USD 26,52 <small>IVA 21%</small>
1787810000	HDC 24B TOBU 1M32G	CAPOTA TAMAÑO 8 enclavamiento lateral HDC-24B-TOBU-1M32G 24 polos (1787810000)	1u.	USD 32,51 <small>IVA 21%</small>
1788430000	HDC 32B TOBU 1M32G	CAPOTA TAMAÑO 10 enclavamiento lateral HDC-32B-TOBU-1M32G 32 polos (1788430000)	1u.	USD 47,47 <small>IVA 21%</small>
1788340000	HDC 48B TOLU 1M40G	CAPOTA TAMAÑO 12 enclavamiento longitudinal HDC-48B-TOLU-1M40G 48 polos (1788340000)	1u.	USD 170,61 <small>IVA 21%</small>

FICHA CON SALIDA LATERAL



CÓD. FABRICANTE	SKU	DESCRIPCIÓN	MASTER	PRECIO
1788810000	HDC 04A TWLU 1M20G	CAPOTA TAMAÑO 1 enclavamiento lateral HDC-04A-TWLU-1M20G 3/4 polos (1788810000)	1u.	USD 13,53 <small>IVA 21%</small>
1788100000	HDC 06B TSLU 1M20G	CAPOTA TAMAÑO 3 enclavamiento longitudinal HDC-06B-TSLU-1M20G 6 polos (1788100000)	1u.	USD 18,14 <small>IVA 21%</small>
1787550000	HDC 10B TSBU 1M25G	CAPOTA TAMAÑO 4 enclavamiento lateral HDC-10B-TSBU-1M25G 10 polos (1787550000)	1u.	USD 23,22 <small>IVA 21%</small>
1788180000	HDC 16B TSBU 1M25G	CAPOTA TAMAÑO 6 enclavamiento longitudinal HDC-16B-TSBU-1M25G 16 polos (1788180000)	1u.	USD 25,92 <small>IVA 21%</small>
1787750000	HDC 24B TSBU 1M32G	CAPOTA TAMAÑO 8 enclavamiento lateral HDC-24B-TSBU-1M32G 24 polos (1787750000)	1u.	USD 32,55 <small>IVA 21%</small>
1788400000	HDC 32B TSBU 1M32G	CAPOTA TAMAÑO 10 enclavamiento lateral HDC-32B-TSBU-1M32G 32 polos (1788400000)	1u.	USD 63,29 <small>IVA 21%</small>
1788310000	HDC 48B TSLU 1M40G	CAPOTA TAMAÑO 12 enclavamiento longitudinal HDC-48B-TSLU-1M40G 48 polos (1788310000)	1u.	USD 116,8 <small>IVA 21%</small>

NÚCLEO MACHO









CÓD. FABRICANTE	SKU	DESCRIPCIÓN	MASTER	PRECIO
1498100000	HDC HA 3 MS	HDC - CONECTOR, Macho, 400 V, 16 A, Número de polos: 3, Conexión brida-tornillo, Tamaño de instalación: 1 (1498100000)	1u.	USD 14,1 <small>IVA 21%</small>
1498300000	HDC HA 4 MS	HDC - CONECTOR, Macho, 400 V, 16 A, Número de polos: 4, Conexión brida-tornillo, Tamaño de instalación: 1 (1498300000)	1u.	USD 19,05 <small>IVA 21%</small>
1200000000	HDC HE 6 MS	HDC - CONECTOR, Macho, 500 V, 24 A, Número de polos: 6, Conexión brida-tornillo, Tamaño de instalación: 3 (1200000000)	1u.	USD 12,37 <small>IVA 21%</small>
1203900000	HDC HE 10 MS	HDC - CONECTOR, Macho, 500 V, 16 A, Número de polos: 10, Conexión brida-tornillo, Tamaño de instalación: 4 HDC-HE-10-MS 10 polos (1203900000)	1u.	USD 18,48 <small>IVA 21%</small>
1207500000	HDC HE 16 MS	HDC - CONECTOR, Macho, 500 V, 16 A, Número de polos: 16, Conexión brida-tornillo, Tamaño de instalación: 6 (1207500000)	1u.	USD 21,66 <small>IVA 21%</small>
1211100000	HDC HE 24 MS	HDC - CONECTOR, Macho, 500 V, 16 A, Número de polos: 24, Conexión brida-tornillo, Tamaño de instalación: 8 (1211100000)	1u.	USD 28,26 <small>IVA 21%</small>
1215700000	HDC HE 16 MS 17-32	HDC - CONECTOR, Macho, 500 V, 16 A, Número de polos: 16, Conexión brida-tornillo, Tamaño de instalación: 6 (1215700000)	1u.	USD 31,72 <small>IVA 21%</small>
1220800000	HDC HE 24 MS 25-48	HDC - CONECTOR, Macho, 500 V, 16 A, Número de polos: 24, Conexión brida-tornillo, Tamaño de instalación: 8 (1220800000)	1u.	USD 38,88 <small>IVA 21%</small>

NÚCLEO HEMBRA



CÓD. FABRICANTE	SKU	DESCRIPCIÓN	MASTER	PRECIO
1498200000	HDC HA 3 FS	HDC - CONECTOR, Hembra, 400 V, 16 A, Número de polos: 3, Conexión brida-tornillo, Tamaño de instalación: 1 (1498200000)	1u.	USD 15,04 <small>IVA 21%</small>
1498400000	HDC HA 4 FS	HDC - CONECTOR, Hembra, 400 V, 16 A, Número de polos: 4, Conexión brida-tornillo, Tamaño de instalación: 1 (1498400000)	1u.	USD 20,23 <small>IVA 21%</small>
1200200000	HDC HE 6 FS	HDC - CONECTOR, Hembra, 500 V, 24 A, Número de polos: 6, Conexión brida-tornillo, Tamaño de instalación: 3 (1200200000)	1u.	USD 13,44 <small>IVA 21%</small>
1204100000	HDC HE 10 FS	HDC - CONECTOR, Hembra, 500 V, 16 A, Número de polos: 10, Conexión brida-tornillo, Tamaño de instalación: 4 HDC-HE-10-FS 10 polos (1204100000)	1u.	USD 18,11 <small>IVA 21%</small>
1207700000	HDC HE 16 FS	HDC - CONECTOR, Hembra, 500 V, 16 A, Número de polos: 16, Conexión brida-tornillo, Tamaño de instalación: 6 (1207700000)	1u.	USD 25,23 <small>IVA 21%</small>
1211300000	HDC HE 24 FS	HDC - CONECTOR, Hembra, 500 V, 16 A, Número de polos: 24, Conexión brida-tornillo, Tamaño de instalación: 8 (1211300000)	1u.	USD 29,96 <small>IVA 21%</small>
1216100000	HDC HE 16 FS 17-32	HDC - CONECTOR, Hembra, 500 V, 16 A, Número de polos: 16, Conexión brida-tornillo, Tamaño de instalación: 6 (1216100000)	1u.	USD 33,34 <small>IVA 21%</small>
1221200000	HDC HE 24 FS 25-48	HDC - CONECTOR, Hembra, 500 V, 16 A, Número de polos: 24, Conexión brida-tornillo, Tamaño de instalación: 8 (1221200000)	1u.	USD 41,14 <small>IVA 21%</small>

BASE ABIERTA

	CÓD. FABRICANTE	SKU	DESCRIPCIÓN	MASTER	PRECIO
	1497600000	HDC 04A ALU	BASE TAMAÑO 1 HDC 04A ALU (1497600000)	1u.	USD 8,93 IVA 21%
	1202100000	HDC 06B ALU	BASE TAMAÑO 3 enclavamiento longitudinal HDC-06B-ALU 6 polos (1202100000)	1u.	USD 21,97 IVA 21%
	1205000000	HDC 10B ABU	BASE TAMAÑO 4 enclavamiento lateral HDC-10B-ABU 10 polos, (1205000000)	1u.	USD 32,65 IVA 21%
	1208600000	HDC 16B ABU	BASE TAMAÑO 6 enclavamiento lateral HDC-16B-ABU 16 polos (1208600000)	1u.	USD 29,24 IVA 21%
	1212400000	HDC 24B ABU	BASE TAMAÑO 8 enclavamiento lateral HDC-24B-ABU 24 polos (1212400000)	1u.	USD 35,53 IVA 21%
	1217800000	HDC 32B ABU	BASE TAMAÑO 10 enclavamiento lateral HDC-32B-ABU 32 polos (1217800000)	1u.	USD 66,56 IVA 21%
	1222900000	HDC 48B ADLU	BASE CON TAPA tamaño 12 HDC-48B-ADLU con TAPA 48 polos (1222900000)	1u.	USD 131,67 IVA 21%

BASE DE ENTRADA LATERAL

	CÓD. FABRICANTE	SKU	DESCRIPCIÓN	MASTER	PRECIO
	1788830000	HDC 04A SLU 1M20G	CAPOTA TAMAÑO 1 HDC 04A SLU 1M20G (1788830000)	1u.	USD 21,14 IVA 21%
	1900460000	HDC 06B SLU 1M20G	BASE ALTA TAMAÑO 3 enclavamiento longitudinal HDC-06B-SLU-1M20G 6 polos (1900460000)	1u.	USD 34,28 IVA 21%
	1901370000	HDC 10B SBU 1M25G	BASE TAMAÑO 4 enclavamiento lateral HDC-10B-SBU-1M25G 10 polos (1901370000)	1u.	USD 53,95 IVA 21%
	1899980000	HDC 16B SBU 1M25G	BASE ALTA TAMAÑO 6 enclavamiento lateral HDC-16B-SBU-1M25G 16 polos (1899980000)	1u.	USD 54,45 IVA 21%
	1901150000	HDC 24B SBU 1M25G	BASE TAMAÑO 8 enclavamiento lateral HDC-24B-SBU-1M25G 24 polos (1901150000)	1u.	USD 58,8 IVA 21%
	1902600000	HDC 32B SBU 1M32G	BASE TAMAÑO 10 enclavamiento lateral HDC-32B-SBU-1M32G 32 polos (1902600000)	1u.	USD 87,71 IVA 21%
	1904190000	HDC 48B SLU 1M32G	BASE ALTA TAMAÑO 12 enclavamiento longitudinal HDC-48B-SLU-1M32G 48 polos (1904190000)	1u.	USD 221,33 IVA 21%

BASE PROLONGACIÓN



CÓD. FABRICANTE	SKU	DESCRIPCIÓN	MASTER	PRECIO
1788840000	HDC 04A KOLU 1M20G	CAPOTA TAMAÑO 1 HDC-04A-KOLU-1M20G (1788840000)	1u.	USD 11,2 IVA 21%



1021330000	HDC 06B KLU 1M25G	CAPOTA T3 HDC-06B-KLU-1M25G 6 polos (1021330000)	1u.	USD 43,03 IVA 21%
------------	-------------------	--	-----	----------------------



1787720000	HDC 10B KBU 1M20G	BASE AEREA tamaño 4 enclavamiento lateral HDC-10B-KBU-1M20G 10 polos (1787720000)	1u.	USD 38,68 IVA 21%
------------	-------------------	---	-----	----------------------



1787200000	HDC 40D KBU 1M25G	BASE AEREA tamaño 6 enclavamiento lateral HDC-40D-KBU-1M25G 16 polos (1787200000)	1u.	USD 52,35 IVA 21%
------------	-------------------	---	-----	----------------------



1787920000	HDC 24B KBU 1M25G	BASE AEREA tamaño 8 enclavamiento lateral HDC-24B-KBU-1M25G 24 polos (1787920000)	1u.	USD 46,17 IVA 21%
------------	-------------------	---	-----	----------------------



1902730000	HDC 32B KBU 1M40G	BASE AEREA tamaño 10 enclavamiento lateral HDC-32B-KBU-1M40G 32 polos (1902730000)	1u.	USD 109,7 IVA 21%
------------	-------------------	--	-----	----------------------



CABLE CON CONECTOR M12

	CÓD. FABRICANTE	SKU	DESCRIPCIÓN	MASTER	PRECIO
	9457740500	SAIL-M12BW-4-5.0U	CABLE PARA SENSORES Y ACTUADORES, Abierto por un lado, M12, Número de polos : 4, 5 m, CONECTOR HEMBRA acodado, Apantallado: No, LED: No, Material de la funda: PUR, Halógenos: No SAIL-M12BW-4-5.0U (9457740500)	1u.	USD 42,58 <small>IVA 21%</small>
	9457731000	SAIL-M12BG-4-10U	CABLE PARA SENSORES Y ACTUADORES, Abierto por un lado, M12, Número de polos : 4, 10 m, CONECTOR HEMBRA, recto, Apantallado: No, LED: No, Material de la funda: PUR, Halógenos: No SAIL-M12BG-4-10U (9457731000)	1u.	USD 32,37 <small>IVA 21%</small>
	9457730500	SAIL-M12BG-4-5.0U	CABLE PARA SENSORES Y ACTUADORES, Abierto por un lado, M12, Número de polos : 4, 5 m, CONECTOR HEMBRA, recto, Apantallado: No, LED: No, Material de la funda: PUR, Halógenos: No SAIL-M12BG-4-5.0U (9457730500)	1u.	USD 38,58 <small>IVA 21%</small>
	9457730200	SAIL-M12BG-4-2.0U	CABLE PARA SENSORES Y ACTUADORES, Abierto por un lado, M12, Número de polos : 4, 2 m, CONECTOR HEMBRA, recto, Apantallado: No, LED: No, Material de la funda: PUR, Halógenos: No SAIL-M12BG-4-2.0U (9457730200)	1u.	USD 38,23 <small>IVA 21%</small>
	9457740200	SAIL-M12BW-4-2.0U	CABLE PARA SENSORES Y ACTUADORES, Abierto por un lado, M12, Número de polos : 4, 2 m, CONECTOR HEMBRA acodado, Apantallado: No, LED: No, Material de la funda: PUR, Halógenos: No SAIL-M12BW-4-2.0U (9457740200)	1u.	USD 38,2 <small>IVA 21%</small>
	9457741000	SAIL-M12BW-4-10U	CABLE PARA SENSORES Y ACTUADORES, Abierto por un lado, M12, Número de polos : 4, 10 m, CONECTOR HEMBRA acodado, Apantallado: No, LED: No, Material de la funda: PUR, Halógenos: No SAIL-M12BW-4-10U (9457741000)	1u.	USD 76,21 <small>IVA 21%</small>

CONECTOR M12 PARA ARMAR



CÓD. FABRICANTE	SKU	DESCRIPCIÓN	MASTER	PRECIO
9457240000	SAIB-4/7	CONECTOR acoplable en campo, M12 SAIB-4/7 (9457240000)	1u.	USD 27,2 <small>IVA 21%</small>
9457700000	SAIBW-4/7	CONECTOR acoplable en campo, M12 SAIBW-4/7 (9457700000)	1u.	USD 34 <small>IVA 21%</small>
9457250000	SAIB-5/7	CONECTOR acoplable en campo, M12 SAIB-5/7 (9457250000)	1u.	USD 32,42 <small>IVA 21%</small>
9457260000	SAIBW-5/7	CONECTOR acoplable en campo, M12 SAIBW-5/7 (9457260000)	1u.	USD 61,94 <small>IVA 21%</small>
9457550000	SAIS-4/7	CONECTOR acoplable en campo, M12 SAIS-4/7 (9457550000)	1u.	USD 25,06 <small>IVA 21%</small>
9457290000	SAISW-4/7	CONECTOR acoplable en campo, M12 SAISW-4/7 (9457290000)	1u.	USD 26,75 <small>IVA 21%</small>
9456940000	SAIS-5/7	CONECTOR acoplable en campo, M12 SAIS-5/7 (9456940000)	1u.	USD 27,42 <small>IVA 21%</small>
9456950000	SAISW-5/7	CONECTOR acoplable en campo, M12 SAISW-5/7 (9456950000)	1u.	USD 37,79 <small>IVA 21%</small>

CABLE CON CONECTOR M8



CÓD. FABRICANTE	SKU	DESCRIPCIÓN	MASTER	PRECIO
9457850500	SAIL-M8BG-4-5.0U	CABLE PARA SENSORES Y ACTUADORES, Abierto por un lado, M8, Número de polos : 4, 5 m, CONECTOR HEMBRA, recto, Apantallado: No, LED: No, Material de la funda: PUR, Halógenos: No SAIL-M8BG-4-5.0U (9457850500)	1u.	USD 61,11 <small>IVA 21%</small>
9456150500	SAIL-M8BW-4-5.0U	CABLE PARA SENSORES Y ACTUADORES, Abierto por un lado, M8, Número de polos : 4, 5 m, CONECTOR HEMBRA acodado, Apantallado: No, LED: No, Material de la funda: PUR, Halógenos: No SAIL-M8BW-4-5.0U (9456150500)	1u.	USD 61,12 <small>IVA 21%</small>
9457450500	SAIL-M8BG-3-5.0U	CABLE PARA SENSORES Y ACTUADORES, Abierto por un lado, M8, Número de polos : 3, 5 m, CONECTOR HEMBRA, recto, Apantallado: No, LED: No, Material de la funda: PUR, Halógenos: No SAIL-M8BG-3-5.0U (9457450500)	1u.	USD 52,72 <small>IVA 21%</small>
9457380500	SAIL-M8BW-3-5.0U	CABLE PARA SENSORES Y ACTUADORES, Abierto por un lado, M8, Número de polos : 3, 5 m, CONECTOR HEMBRA acodado, Apantallado: No, LED: No, Material de la funda: PUR, Halógenos: No SAIL-M8BW-3-5.0U (9457380500)	1u.	USD 49,61 <small>IVA 21%</small>

CONECTOR M8 PARA ARMAR



CÓD. FABRICANTE	SKU	DESCRIPCIÓN	MASTER	PRECIO
1803870000	SAIB-M8-3P	CONECTOR Circular - SAIB-M8-3P (1803870000)	1u.	USD 35,14 IVA 21%
1803880000	SAIB-M8-4P	CONECTOR Circular - SAIB-M8-4P (1803880000)	1u.	USD 51,04 IVA 21%
1803860000	SAIS-M8-3P	CONECTOR Circular - SAIS-M8-3P (1803860000)	1u.	USD 35,16 IVA 21%
1803850000	SAIS-M8-4P	CONECTOR Circular - SAIS-M8-4P (1803850000)	1u.	USD 47,38 IVA 21%



# ETHERNET INDUSTRIAL

Los componentes de Ethernet industrial de Weidmüller son las piezas de conexión ideales para la comunicación de datos entre aparatos compatibles con Ethernet en la automatización industrial. Gracias a su compatibilidad con topologías y protocolos diferentes, se pueden emplear en múltiples aplicaciones industriales. Como proveedor completo de infraestructuras de red industrial para máquinas y equipos de fabricación, ofrecemos una amplia gama de switches que se ajusta a las necesidades individuales de nuestros clientes.



SWITCHES SIN GESTIÓN



CÓD. FABRICANTE	SKU	DESCRIPCIÓN	MASTER	PRECIO
2828540000	IE-SW-ELB-05-5TX	SWITCH DE RED, sin gestion, Fast Ethernet, Número de puertos: 5x RJ45, IP40, -10 °C...60 °C IE-SW-ELB-05-5TX (2828540000)	1u.	USD 226,29 <small>IVA 10.5%</small>
2828550000	IE-SW-ELB-08-8TX	SWITCH DE RED, sin gestion, Fast Ethernet, Número de puertos: 8x RJ45, IP40, -10 °C...60 °C IE-SW-ELB-08-8TX (2828550000)	1u.	USD 312,91 <small>IVA 10.5%</small>
2828560000	IE-SW-ELB-05-5GT	SWITCH DE RED, sin gestion, Gigabit Ethernet, Número de puertos: 5x RJ45, IP40, -10 °C...60 °C IE-SW-ELB-05-5GT (2828560000)	1u.	USD 483,92 <small>IVA 10.5%</small>
2828570000	IE-SW-ELB-08-8GT	SWITCH DE RED, sin gestion, Gigabit Ethernet, Número de puertos: 8x RJ45, IP40, -10 °C...60 °C IE-SW-ELB-08-8GT (2828570000)	1u.	USD 650,25 <small>IVA 10.5%</small>
2828580000	IE-SW-ELB-16-16TX	SWITCH DE RED, sin gestion, Fast Ethernet, Número de puertos: 16x RJ45, IP40, -10 °C...60 °C IE-SW-ELB-16-16TX (2828580000)	1u.	USD 979,45 <small>IVA 10.5%</small>
2828590000	IE-SW-ELB-05-4TX-1FESFP	SWITCH DE RED, sin gestion, Fast Ethernet, Número de puertos: 4x RJ45, 1x 100BaseSFP slot, IP40, -10 °C...60 °C IE-SW-ELB-05-4TX-1FESFP (2828590000)	1u.	USD 521,89 <small>IVA 10.5%</small>
2828600000	IE-SW-ELB-08-6TX-2FESFP	SWITCH DE RED, sin gestion, Fast Ethernet, Número de puertos: 6x RJ45, 2x 100BaseSFP slot, IP40, -10 °C...60 °C IE-SW-ELB-08-6TX-2FESFP (2828600000)	1u.	USD 627,74 <small>IVA 10.5%</small>
2682190000	IE-SW-EL24-24TX	SWITCH DE RED, sin gestion, Fast Ethernet, Número de puertos: 24x RJ45, IP30, -40 °C...75 °C IE-SW-EL24-24TX (2682190000)	1u.	USD 1.848,57 <small>IVA 10.5%</small>

SWITCHES DE ALTAS PRESTACIONES



CÓD. FABRICANTE	SKU	DESCRIPCIÓN	MASTER	PRECIO
2682370000	IE-SW-AL24M-16GT-8GESFP	SWITCH DE RED, gestionable, Gigabit Ethernet, Número de puertos: 16x RJ45, 8x 100/1000BaseSFP Slot, IP30, -40 °C...75 °C IE-SW-AL24M-16GT-8GESFP (2682370000)	1u.	USD 4.045,24 <small>IVA 10.5%</small>
2682280000	IE-SW-AL08M-8TX	SWITCH DE RED, gestionable, Fast Ethernet, Número de puertos: 8x RJ45, IP30, -40 °C...75 °C IE-SW-AL08M-8TX (2682280000)	1u.	USD 1.540,41 <small>IVA 10.5%</small>
2682350000	IE-SW-AL08M-8GT	SWITCH DE RED, gestionable, Gigabit Ethernet, Número de puertos: 8x RJ45, IP30, -40 °C...75 °C IE-SW-AL08M-8GT (2682350000)	1u.	USD 2.367,27 <small>IVA 10.5%</small>
2682380000	IE-SW-EL08-8POE	SWITCH DE RED, sin gestion PoE, Fast Ethernet, Número de puertos: 8x RJ45 10/100 BaseT(X) PoE+, IP30, -40 °C...75 °C IE-SW-EL08-8POE (2682380000)	1u.	USD 1.424,68 <small>IVA 10.5%</small>
2682440000	IE-INJ-EL02-2GTPOE	INYECTOR PoE, Gigabit Ethernet, Número de puertos: 2x RJ45 10/100/1000BaseT(X), 2x RJ45 10/100/1000 BaseT(X) PoE+, IP30, -40 °C...75 °C IE-INJ-EL02-2GTPOE (2682440000)	1u.	USD 712,89 <small>IVA 10.5%</small>

## MEDIA CONVERTERS / GATEWAYS



CÓD. FABRICANTE	SKU	DESCRIPCIÓN	MASTER	PRECIO
1241400000	IE-MC-VL-1TX-1SC	CONVERTIDOR de cables, Fast Ethernet, Número de puertos: 1x RJ45, 1 * SC Multimodo, IP30, 0 °C...60 °C IE-MC-VL-1TX-1SC (1241400000)	1u.	USD 979,78 IVA 10,5%
1241410000	IE-MC-VL-1TX-1ST	CONVERTIDOR de cables, Fast Ethernet, Número de puertos: 1x RJ45, 1 * ST Multimodo, IP30, 0 °C...60 °C IE-MC-VL-1TX-1ST (1241410000)	1u.	USD 979,06 IVA 10,5%
2682600000	IE-CS-MBGW-2TX-1COM	CONVERTIDOR serial/Ethernet y pasarela Modbus TCP/RTU, Número de puertos: 2x RJ45 10/100BASE-T(X), 1x DB9 male for RS-232/422/485, IP30, -40 °C...70 °C IE-CS-MBGW-2TX-1COM (2682600000)	1u.	USD 979,75 IVA 10,5%







## WIFI ACCESS POINTS



CÓD. FABRICANTE	SKU	DESCRIPCIÓN	MASTER	PRECIO
2536700000	IE-WL-VL-AP-BR-CL-US	ACCESS POINT INALÁMBRICO Wireless/Bridge/Cliente, IEEE 802.11 a/b/g/n, modelo US, IP30, -25 °C...60 °C IE-WL-VL-AP-BR-CL-US (2536700000)	1u.	USD 2.064,56 IVA 10,5%
2536660000	IE-WL-BL-AP-CL-US	ACCESS POINT INALÁMBRICO, IEEE 802.11 a/b/g/n, modelo US, IP30, 0 °C...60 °C IE-WL-BL-AP-CL-US (2536660000)	1u.	USD 15.40,86 IVA 10,5%



ACCESORIOS INDUSTRIALES ETHERNET

	CÓD. FABRICANTE	SKU	DESCRIPCIÓN	MASTER	PRECIO
	1241440000	RM-KIT	Kit para montaje en rack de 19" (1241440000)	1u.	USD 764,35 <small>IVA 10,5%</small>
	1963600000	IE-PS-RJ45-FH-BK	CONECTOR macho sin herramientas 5, Cat.6A / Class EA (ISO/IEC 11801 2010), 8 núcleos, 4 núcleos, EIA/TIA T568 A, EIA/TIA T568 B, PROFINETIE-PS-RJ45-FH-BK (1963600000)	10u.	USD 46,29 <small>IVA 21%</small>
	1018790000	IE-FCM-RJ45-C	FrontCom Micro acoplamiento RJ45 IE-FCM-RJ45-C (1018790000)	10u.	USD 54,06 <small>IVA 21%</small>
	2763540000	IE-C7BS8VG-500	Cable de instalación, Cat.7 (ISO/IEC 11801), PVC, 500 m IE-C7BS8VG-500 (2763540000)	1u.	USD 5.197,84 <small>IVA 21%</small>
	1344680000	IE-C7FS8LG-305M	Cable de sistema, Cat.7 (ISO/IEC 11801), Poco humo, cero halógenos (LSZH), 305 mm IE-C7FS8LG-305M (1344680000)	1u.	USD 2.344,28 <small>IVA 21%</small>
	1963590000	IE-PS-RJ45-TH-BK	CONECTOR RJ45 crimpado, CONECTOR con protector antidoblado de cables en NEGRO, Cat.6A / Class EA IE-PS-RJ45-TH-BK (1963590000)	10u.	USD 10,26 <small>IVA 21%</small>
	1963600000	IE-PS-RJ45-FH-BK	CONECTOR macho sin herramientas 5, Cat.6A / Class EA (ISO/IEC 11801 2010), 8 núcleos, 4 núcleos, EIA/TIA T568 A, EIA/TIA T568 B, PROFINETIE-PS-RJ45-FH-BK (1963600000)	10u.	USD 46,29 <small>IVA 21%</small>
	8946920000	IE-TO-RJ45-C	Salida de carril RJ45, Acoplamiento, IP20, Cat.6A / Class EA (ISO/IEC 11801 2010) IE-TO-RJ45-C (8946920000)	1u.	USD 95,76 <small>IVA 21%</small>
	8946930000	IE-TO-RJ45-FJ-A	Salida de carril RJ45, EIA/TIA T568 A, IP20, Cat.6A / Class EA (ISO/IEC 11801 2010) IE-TO-RJ45-FJ-A (8946930000)	10u.	USD 106,92 <small>IVA 21%</small>
	1165940002	IE-C6FP8LD-0002M40M40-D	PATCHCORD, RJ45 IP20, RJ45 IP20, <20 m: Cat.6A / >20 m Class EA (ISO/IEC 11801 2010), Poco humo, cero halógenos (LSZH), 0,2 m IE-C6FP8LD0002M40M40-D (1165940002)	1u.	USD 14,57 <small>IVA 21%</small>
	1165940005	IE-C6FP8LD-0005M40M40-D	PATCHCORD, RJ45 IP20, RJ45 IP20, <20 m: Cat.6A / >20 m Class EA (ISO/IEC 11801 2010), Poco humo, cero halógenos (LSZH), 0,5 m IE-C6FP8LD0005M40M40-D (1165940005)	1u.	USD 15,23 <small>IVA 21%</small>
	1165940015	IE-C6FP8LD-0015M40M40-D	PATCHCORD, RJ45 IP20, RJ45 IP20, <20 m: Cat.6A / >20 m Class EA (ISO/IEC 11801 2010), Poco humo, cero halógenos (LSZH), 1,5 m IE-C6FP8LD0015M40M40-D (1165940015)	1u.	USD 23,94 <small>IVA 21%</small>
	1165940030	IE-C6FP8LD-0030M40M40-D	PATCHCORD, RJ45 IP20, RJ45 IP20, <20 m: Cat.6A / >20 m Class EA (ISO/IEC 11801 2010), Poco humo, cero halógenos (LSZH), 3 m IE-C6FP8LD0030M40M40-D (1165940030)	1u.	USD 32,26 <small>IVA 21%</small>
	1165940050	IE-C6FP8LD-0050M40M40-D	PATCHCORD, RJ45 IP20, RJ45 IP20, <20 m: Cat.6A / >20 m Class EA (ISO/IEC 11801 2010), Poco humo, cero halógenos (LSZH), 5 m IE-C6FP8LD0050M40M40-D (1165940050)	1u.	USD 45,62 <small>IVA 21%</small>
	1344680000	IE-C7FS8LG-305M	Cable de sistema, Cat.7 (ISO/IEC 11801), Poco humo, cero halógenos (LSZH), 305 mm IE-C7FS8LG-305M (1344680000)	1u.	USD 2.344,28 <small>IVA 21%</small>
	8813130000	IE-7IC4X2XAWG23/1-PVC	Cable de instalación, Cat.7 (ISO/IEC 11801), PVC, 100 m IE-C7BS8VG-100 (8813130000)	1u.	USD 722,69 <small>IVA 21%</small>



# AUTOMATIZACIÓN INDUSTRIAL

Optimiza tu automatización - fácil y preparado para la IoT

## PLC (EDGING PLC - NODE RED / ETHERNET - MODBUS)



CÓD. FABRICANTE	SKU	DESCRIPCIÓN	MASTER	PRECIO
1334950000	UC20-WL2000-AC	Controlador UC20-WL2000-AC PLC 2x Ethernet TCP/IP, 1x Micro USB (1334950000)	1u.	USD 2.079,86 IVA 21%
1487980000	IE-USB-A-MICRO-1.8M	Cable USB, USB A, USB Micro, PVC, 1.8 m (1487980000)	1u.	USD 23,69 IVA 21%

## WEIDMÜLLER U-CONTROL STARTER KIT



CÓD. FABRICANTE	SKU	DESCRIPCIÓN	MASTER	PRECIO
2666080000	STARTERKIT-UC20-WL2000-AC	STARTERKIT-UC20-WL2000-AC (2666080000)	1u.	USD 5.171 IVA 21%

## FIELD BUS COUPLER (FBC)



CÓD. FABRICANTE	SKU	DESCRIPCIÓN	MASTER	PRECIO
2476450000	UR20-FBC-MOD-TCP-V2	CABECERA DE BUS DE CAMPO DE E/S remoto, IP20, Ethernet, Modbus/TCP UR20-FBC-MOD-TCP-V2 (2476450000)	1u.	USD 1.478,13 IVA 21%
1550550000	UR20-FBC-EIP-V2	CABECERA DE BUS DE CAMPO DE E/S remoto, IP20, Ethernet, EtherNet/IP UR20-FBC-EIP-V2 (1550550000)	1u.	USD 1.804,46 IVA 21%
2566380000	UR20-FBC-PN-IRT-V2	CABECERA DE BUS DE CAMPO DE E/S remoto, IP20, Ethernet, PROFINET IRT+RT UR20-FBC-PN-IRT-V2 (2566380000)	1u.	USD 1.806,16 IVA 21%

## MÓDULOS DE ENTRADAS Y SALIDAS DIGITALES



CÓD. FABRICANTE	SKU	DESCRIPCIÓN	MASTER	PRECIO
2009360000	UR20-4DI-P-3W	MÓDULO DE E/S REMOTO, IP20, Señales digitales, Entrada, 4 canales UR20-4DI-P-3W (2009360000)	1u.	USD 207,94 <small>IVA 21%</small>
1315180000	UR20-8DI-P-2W	MÓDULO DE E/S REMOTO, IP20, Señales digitales, Entrada, 8 canales, Sistema de conexión con 2 conductores UR20-8DI-P-2W (1315180000)	1u.	USD 310,68 <small>IVA 21%</small>
1315200000	UR20-16DI-P	MÓDULO DE E/S REMOTO, IP20, Señales digitales, Entrada, 16 canales UR20-16DI-P (1315200000)	1u.	USD 419,39 <small>IVA 21%</small>
1315220000	UR20-4DO-P	MÓDULO DE E/S REMOTO, IP20, Señales digitales, Salida, 4 canales UR20-4DO-P (1315220000)	1u.	USD 230,01 <small>IVA 21%</small>
1315240000	UR20-8DO-P	MÓDULO DE E/S REMOTO, IP20, Señales digitales, Salida, 8 canales UR20-8DO-P (1315240000)	1u.	USD 357,32 <small>IVA 21%</small>
1315250000	UR20-16DO-P	MÓDULO DE E/S REMOTO, IP20, Señales digitales, Salida, 16 canales UR20-16DO-P (1315250000)	1u.	USD 497,04 <small>IVA 21%</small>

## MÓDULOS DE ENTRADAS Y SALIDAS ANALÓGICAS



CÓD. FABRICANTE	SKU	DESCRIPCIÓN	MASTER	PRECIO
1315690000	UR20-4AI-UI-16-DIAG	MÓDULO DE E/S REMOTO, IP20, 4 canales, Señales analógicas, Entrada, Intensidad/Tensión, 16 bits UR20-4AI-UI-16-DIAG (1315690000)	1u.	USD 1.164,71 <small>IVA 21%</small>
1315730000	UR20-4AO-UI-16-DIAG	MÓDULO DE E/S REMOTO, IP20, Señales analógicas, Salida, 4 canales, Intensidad/Tensión UR20-4AO-UI-16-DIAG (1315730000)	1u.	USD 1.319,96 <small>IVA 21%</small>

## MÓDULOS DE TEMPERATURA



CÓD. FABRICANTE	SKU	DESCRIPCIÓN	MASTER	PRECIO
1315710000	UR20-4AI-TC-DIAG	MÓDULO DE E/S REMOTO, IP20, Señales analógicas, Temperatura, TC UR20-4AI-TC-DIAG (1315710000)	1u.	USD 976,68 <small>IVA 21%</small>
2555940000	UR20-8AI-RTD-DIAG-2W	MÓDULO DE E/S REMOTO, IP20, Señales analógicas, Temperatura, RTD UR20-8AI-RTD-DIAG-2W (2555940000)	1u.	USD 827,12 <small>IVA 21%</small>

## MÓDULOS DE TEMPERATURA



CÓD. FABRICANTE	SKU	DESCRIPCIÓN	MASTER	PRECIO
1315750000	UR20-1COM-232-485-422	MÓDULO DE E/S REMOTO, IP20, 1 canal, Comunicación RS232/RS485/RS422, Conexión PUSH IN UR20-1COM-232-485-422 (1315750000)	1u.	USD 907,87 IVA 21%
2007420000	UR20-3EM-230V-AC	MÓDULO DE E/S REMOTO, IP20, 6 canales, Entrada, Medición de corriente, Conexión PUSH IN UR20-3EM-230V-AC (2007420000)	1u.	USD 844,66 IVA 21%
1990070000	UR20-2AI-SG-24-DIAG	MÓDULO DE E/S REMOTO, IP20, Señales analógicas, Entrada, Conexión PUSH IN UR20-2AI-SG-24-DIAG (1990070000)	1u.	USD 1.025,76 IVA 21%
1315740000	UR20-4COM-IO-LINK	MÓDULO DE E/S REMOTO, IP20, 4 canales, Módulo de comunicación, Conexión PUSH IN UR20-4COM-IO-LINK (1315740000)	1u.	USD 1060,74 IVA 21%
1334710000	UR20-PF-I	MÓDULO DE E/S REMOTO, IP20, Fuente de alimentación, Entrada 24 V DC UR20-PF-I (1334710000)	1u.	USD 201,95 IVA 21%
1334740000	UR20-PF-O	MÓDULO DE E/S REMOTO, IP20, Fuente de alimentación, Salida 24 V DC UR20-PF-O (1334740000)	1u.	USD 201,98 IVA 21%
1315610000	UR20-2PWM-PN-2A	MÓDULO DE E/S REMOTO, IP20, Señales digitales, Módulo especial, PWM, 2 A por canal UR20-2PWM-PN-2A (1315610000)	1u.	USD 1.087,1 IVA 21%
1315570000	UR20-1CNT-100-1DO	MÓDULO DE E/S REMOTO, IP20, Señales digitales, Entrada, Conexión PUSH IN, Contador, monocal UR20-1CNT-100-1DO (1315570000)	1u.	USD 776,55 IVA 21%
1315590000	UR20-2CNT-100	MÓDULO DE E/S REMOTO, IP20, Señales digitales, Entrada, Conexión PUSH IN, Contador, bicanal UR20-2CNT-100 (1315590000)	1u.	USD 931,81 IVA 21%

## HDMI



CÓD. FABRICANTE	SKU	DESCRIPCIÓN	MASTER	PRECIO
2555790000	UV66-ECO-10-RES-W	Panel táctil compatible con web, Tamaño de pantalla 10,1", resistente, Protección frontal IP66 UV66-ECO-10-RES-W (2555790000)	1u.	USD 2.665,66 IVA 10.5%
2932860000	UV66-ADV-15-CAP-W-V2	Pantalla táctil 15" Advanced UV66-ADV-15-CAP-W-V2 (2932860000)	1u.	USD 4.646,61 IVA 10.5%



CÓD. FABRICANTE	SKU	DESCRIPCIÓN	MASTER	PRECIO
	7760051002	EM110-RTU-2P	MULTIMEDIDOR MEDICIÓN/visualización de potencia de la red monofásica, uso de CT, salida de impulso, Modbus RTU EM110-RTU-2P (7760051002)	1u. USD 175,78 IVA 10.5%
	7760051001	EM111-RTU-2P	MULTIMEDIDOR MEDICIÓN/visualización de potencia de la red monofásica, 45 A, medición directa, salida de impulso, Modbus RTU EM111-RTU-2P (7760051001)	1u. USD 175,79 IVA 10.5%
	7760051003	EM122-RTU-2P	MULTIMEDIDOR MEDICIÓN/visualización de potencia de la red monofásica, trifásica, 100 A, medición directa, salida de impulso, Modbus RTU (7760051003)	1u. USD 599,92 IVA 10.5%
	7760051005	EM220-RTU-4DI2DO	MULTIMEDIDOR MEDICIÓN/visualización de potencia de la red monofásica, trifásica, uso de CT, salida de impulso, entrada/salida digital, Modbus RTU (7760051005)	Imagen USD 621,01 IVA 10.5%
	2540880000	ENERGY METER 525-24	ENERGY METER 525-24 Medición/visualización de potencia de la red monofásica, trifásica. Con Modbus TCP/IP, Modbus RTU over Ethernet, SNMP (2540880000)	1u. USD 1.489,06 IVA 10.5%
	2500880000	ENERGY METER 520-230	ENERGY METER 520-230 - Medición/visualización de potencia de la red monofásica, trifásica. Con Modbus RTU (2500880000)	1u. USD 1.338,02 IVA 10.5%
	2540910000	ENERGY METER 750-230	ENERGY METER 750-230 Medición/visualización de potencia de la red monofásica, trifásica. Con Modbus TCP/IP, Modbus RTU over Ethernet, SNMP (2540910000)	1u. USD 2.743,14 IVA 10.5%
	2420710000	KCMA-44-750-5A-5VA-1	Transformador nucleo partido Corriente principal: 750 A, Corriente secundaria máx.: 5 A, Carga: 5 VA, Clase de exactitud: 1 KCMA-44-750-5A-5VA-1 (2420710000)	1u. USD 491,75 IVA 21%

## Derecho de Imagen y Representación

Todo el contenido visual (imágenes, fotografías, logotipos, etc.) de nuestras marcas Macroled, PowerSwitch e Inteck y por consiguiente de la marca CHINT y Astronergy donde actuamos como representante oficial en el país son propiedad intelectual pertenecientes a Coresa Group SRL, queda terminantemente prohibido el uso inadecuado o la reproducción de contenido sin autorización escrita por parte de la empresa. En caso de poseer dicha autorización, el contenido visual utilizado deberá estar acompañado por nuestra marca madre Coresa Group y/o por la siguiente descripción: "Propiedad Intelectual de Coresa Group SRL todos los derechos Reservados". O una marca del grupo Coresa.

### CUENTA BANCARIA

Titular: Coresa Group SRL

CUIT: 30-71178446-9

CBU: 0720762620000002861618

Cuenta Cte: 762-028616/1

Sucursal: Pellegrini (018/6)

### GERENCIA COMERCIAL

Dirección: Laminar Plaza: Ingeniero Butty 240, piso 10.

Tel: 0810-222-2882

-----

Interno ---

### GERENTE LOGÍSTICO

Contacto: Santiago Osorio

0810 222 2882

Interno 103

santiago.osorio@coresagroup.com.ar

Centro Logístico 3 de Febrero - Grupo Posadas. Km 10, Au Cam. del Buen Ayre, 1678 Buenos Aires

HORARIOS DE ATENCIÓN Lunes a Viernes de 9:00 a 18:00 hs

DESCUENTO	TODA LA LISTA	MACROLED	RESTO	CHINT	UNIVIEW
	..... %	..... %	..... %	..... %	..... %
Forma de pago	LC=USO : LC + LCC				
Envíos sin cargo desde: USD.	..... .....				
Facturación \$ (TIPO DE CAMBIO BNA - BANCO NACIÓN ARGENTINA)					
Garantías: Macroled General 2 años, Macroled Alta Potencia 5 años, PowerSwitch 2 años CHINT 3 años, CHINT Power 5 años, Astronergy 10 Años MACROLED, 1, 2, LÍNEA PRO 3 O LÍNEA ALTA POTENCIA 5 AÑOS, CHINT 3 AÑOS, UNV 1, 2 AÑOS					
Capacitaciones Técnicas y Comerciales.	..... .....				
Acciones de Marketing en punto de Venta.	..... .....				
Observaciones.	..... .....				