



LISTA DE PRECIOS

- MARZO 2026 -

MACROLED®

Línea Bulbos	P.03	Luminaria LED estanco listones para tubos	P.63
Líneas Bulbones - Highpower	P.05	Artefacto LED estanco	P.64
Líneas Filamento DECO - Golden - Colors	P.07	Luces de emergencia - Linterna PRO	P.65
Líneas PAR 30 / PAR 38	P.10	Señales luminosas	P.68
Línea PAR16	P.11	Paneles de gran formato & drivers	P.69
Línea AR111	P.13	Accesorios paneles de gran formato	P.70
Línea AR111 PRO - Mirror	P.14	NUEVO Paneles de gran formato Backlight	P.71
Línea BIPIN	P.16	Paneles COB	P.72
Guirnaldas	P.17	Paneles LED 6 a 24	P.73
Portalámparas aluminio	P.18	Listón T5	P.79
Cables textiles	P.19	S K Y L I N E	P.80
Portalámparas	P.20	Tortugas LED	P.98
Aros embutir MR16	P.21	Estacas de jardín y solares	P.99
Artefactos MR16	P.22	Luz de pared y de calle solar	P.100
Artefactos AR111	P.23	Reflectores LED PRO	P.103
Artefactos MR16	P.24	Reflectores LED	P.106
Artefactos embutir PC	P.25	Reflectores TITÁN	P.109
Artefacto plafón PC	P.27	Reflectores OLIMPUS	P.110
Artefactos de pared exterior	P.28	Reflectores FOCUS	P.111
Línea SMART	P.29	Reflector Industrial	P.113
NUEVO Línea MILAN	P.31	Highbay	P.114
Línea ROMA	P.44	NUEVO Luminaria pública LUMAX	P.117
Teclas TOKIO	P.46	NUEVO Luminaria Pública PRO	P.118
Teclas KINETIC	P.47	Farolas	P.119
Interruptor y Toma SMART	P.48	NUEVO Tiras COB	P.120
Sensores SMART	P.49	NUEVO Conectores para tiras COB	P.121
Fotocélulas y sensores comunes	P.51	NUEVO Sensores para tiras COB/NEON/SMD	P.123
Sensores comunes	P.52	NUEVO Perfiles de aluminio	P.124
Luminaria de Pie	P.53	NUEVO Tiras NEON	P.129
Luminaria de Mesa	P.54	NUEVO Accesorios para tiras NEON	P.131
NUEVO Luminaria Inalámbrica	P.56	NUEVO Tiras NEON 360°	P.133
Línea TUBOS	P.62	NUEVO Accesorios para tiras NEON 360°	P.134
Luminaria LED estanco listones para tubos	P.63	Tiras SMD	P.136
Línea TUBOS	P.62	Conectores para tiras SMD	P.138
		Controladoras	P.139

 [Clickeá en el título para ir a la página](#)

POWERSWITCH[®]

NUEVO	Fuentes LED Slim - Fuentes LED Slim Dimerizable	P.141
	Fuentes Switching	P.142
	Fuentes Switching con riel DIN	P.143
NUEVO	Baterías alcalinas	P.144



A55 6.5W / E27 / 55X103mm					VIDA ÚTIL	MASTER	PRECIO SIN IVA
BT-55-7WW	220°	3000°K	690lm	106 lm/W	15.000hs	100u.	0,62 USD
BT-55-7NW	220°	4500°K	690lm	106 lm/W	15.000hs	100u.	
BT-55-7CW	220°	6500°K	690lm	106 lm/W	15.000hs	100u.	
							IVA 10,5%



BULBO A60 9,5W / E27 / 60X113mm					VIDA ÚTIL	MASTER	PRECIO SIN IVA
BT-60-10WW	220°	3000°K	950lm	100 lm/W	15.000hs	100u.	0,67 USD
BT-60-10NW	220°	4500°K	950lm	100 lm/W	15.000hs	100u.	
BT-60-10CW	220°	6500°K	950lm	100 lm/W	15.000hs	100u.	
							IVA 10,5%



BULBO A60 11,5W / E27 / 60X118mm					VIDA ÚTIL	MASTER	PRECIO SIN IVA
BT-60-12WW	220°	3000°K	1100lm	95,6 lm/W	15.000hs	100u.	0,86 USD
BT-60-12NW	220°	4500°K	1100lm	95,6 lm/W	15.000hs	100u.	
BT-60-12CW	220°	6500°K	1100lm	95,6 lm/W	15.000hs	100u.	
							IVA 10,5%



BULBO A60 14,5W / E27 / 60X118mm					VIDA ÚTIL	MASTER	PRECIO SIN IVA
BT-60-15WW	220°	3000°K	1400lm	96,5 lm/W	15.000hs	100u.	0,99 USD
BT-60-15NW	220°	4500°K	1400lm	96,5 lm/W	15.000hs	100u.	
BT-60-15CW	220°	6500°K	1400lm	96,5 lm/W	15.000hs	100u.	
							IVA 10,5%



PERFUME LED 3W / E14 / 18X25mm					VIDA ÚTIL	MASTER	PRECIO SIN IVA
BTF-1.8-14WW	360°	2700°K	140lm	77,7 lm/W	15000hs	100u./600u.	2,14 USD
BTF-1.8-14CW	360°	6000°K	155lm	86,1 lm/W	15000hs	100u./600u.	
							IVA 10,5%



PERFUME LED 3W / E14 / 18X25mm					VIDA ÚTIL	MASTER	PRECIO SIN IVA
BTF-4-14WW	360°	2700°K	270lm	90 lm/W	15000hs	100u./600u.	2,96 USD
BTF-4-14CW	360°	6000°K	280lm	93,3 lm/W	15000hs	100u./600u.	
							IVA 10,5%



VELA C37 6W / E27 & E14 / 36,5X100mm					VIDA ÚTIL	MASTER	PRECIO SIN IVA
G45-6-E27-WW	200°	3000°K	520lm	86 lm/W	25.000hs	100u.	0,88 USD
G45-6-E27-CW	200°	6000°K	520lm	86 lm/W	25.000hs	100u.	
G45-6-E14-WW	200°	3000°K	520lm	86 lm/W	25.000hs	100u.	
G45-6-E14-CW	200°	6000°K	520lm	86 lm/W	25.000hs	100u.	
							IVA 10,5%



VELA C37 6W / E27 & E14 / 36,5X100mm					VIDA ÚTIL	MASTER	PRECIO SIN IVA
C37-6-E27-WW	200°	3000°K	520lm	86 lm/W	25.000hs	100u.	0,86 USD
C37-6-E27-CW	200°	6000°K	520lm	86 lm/W	25.000hs	100u.	
C37-6-E14-WW	200°	3000°K	520lm	86 lm/W	25.000hs	100u.	
C37-6-E14-CW	200°	6000°K	520lm	86 lm/W	25.000hs	100u.	
							IVA 10,5%



GLOBO G95 14W / E27 / 95X135mm					VIDA ÚTIL	MASTER	PRECIO SIN IVA
G95-14-E27-WW	200°	3000K	1600lm	114 lm/W	25.000hs	20u.	5,62 USD
G95-14-E27-CW	200°	6000K	1600lm	114 lm/W	25.000hs	20u.	
							IVA 10,5%



GLOBO G120 18W / E27 / 120X158mm					VIDA ÚTIL	MASTER	PRECIO SIN IVA
G120-18-E27-WW	200°	3000K	2140lm	118,8 lm/W	25.000hs	20u.	8,79 USD
G120-18-E27-CW	200°	6000K	2140lm	118,8 lm/W	25.000hs	20u.	
							IVA 10,5%



Vida Útil
9.000hs
8.000 ON/OFF

Iluminación Mejorada
90lm x watt

Factor Potencia
0.5
AC185-265V



Vida Útil
15.000hs
15.000 ON/OFF

Iluminación Mejorada
90lm x watt

Factor Potencia
0.9
AC175-265V



Vida Útil
15.000hs
15.000 ON/OFF

Iluminación Mejorada
100lm x watt

Factor Potencia
0.9
AC185-265V



BULBÓN 19W / E27 / 80X120mm	FP	VIDA ÚTIL	PRECIO SIN IVA	PRECIO SIN IVA				
C-BAP-20CW	180°	6500°K	1.710lm	90 lm/W	0.5	9000hs	50u.	1,62 USD
								IVA 10,5%



BULBÓN 19W / E27 / 80X120mm	FP	VIDA ÚTIL	PRECIO SIN IVA	PRECIO SIN IVA				
C-BAP-30CW	180°	6500°K	2.500lm	89,2lm/W	0.5	9000hs	40u.	2,62 USD
								IVA 10,5%



BULBÓN 19W / E27 / 80X120mm	FP	VIDA ÚTIL	PRECIO SIN IVA	PRECIO SIN IVA				
C-BAP-40CW	180°	6500°K	3.540lm	93,1lm/W	0.5	9000hs	20u.	3,73 USD
								IVA 10,5%



BULBÓN LED 48W / E27 / 140X191mm	FP	VIDA ÚTIL	PRECIO SIN IVA	PRECIO SIN IVA				
C-BAP-50CW	180°	6500°K	3.540lm	93,1lm/W	0.5	9000hs	20u.	5,08 USD
								IVA 10,5%



BULBÓN LED 60W / E40 / 140X208mm	FP	VIDA ÚTIL	PRECIO SIN IVA	PRECIO SIN IVA				
C-BAP-60-E40-CW	270°	6500°K	5.400lm	90lm/W	0.5	15.000 hs	20u.	7,62 USD
								IVA 10,5%



HIGHPOWER BULBON LED 20W / E27 / 80X147mm	FP	VIDA ÚTIL	PRECIO SIN IVA	PRECIO SIN IVA				
BAP-20-E27-WW	180°	3000°K	2000lm	100lm/W	0.9	15000hs	20u.	2,45 USD
BAP-20-E27-CW	180°	6500°K	2000lm	100lm/W	0.9	15000hs	20u.	
								IVA 10,5%



HIGHPOWER BULBON LED 30W / E27 / 100X188mm	FP	VIDA ÚTIL	PRECIO SIN IVA	PRECIO SIN IVA				
BAP-30-E27-WW	180°	3000°K	3000lm	100lm/W	0.9	15000hs	20u.	3,53 USD
BAP-30-E27-CW	180°	6500°K	3000lm	100lm/W	0.9	15000hs	20u.	
								IVA 10,5%



HIGHPOWER BULBON LED 40W / E27 / 120X220mm	FP	VIDA ÚTIL	PRECIO SIN IVA	PRECIO SIN IVA				
BAP-40-E27-WW	180°	3000°K	4000lm	100lm/W	0.9	15000hs	12u.	5,25 USD
BAP-40-E27-WW	180°	6500°K	4000lm	100lm/W	0.9	15000hs	12u.	
								IVA 10,5%



HIGHPOWER BULBON LED 60W / E27 / 120X275mm	FP	VIDA ÚTIL	PRECIO SIN IVA	PRECIO SIN IVA				
BAP-60-E27-WW	180°	3000°K	6000lm	100lm/W	0.9	15000hs	8u.	8,20 USD
BAP-60-E27-WW	180°	6500°K	6000lm	100lm/W	0.9	15000hs	8u.	
								IVA 10,5%



Vida Útil
25.000hs
2 años de garantía

**Disipador
abierto
de Aluminio**



**Iluminación
Mejorada**
100lm x watt

**Driver
Mejorado**
AC100-240V
PF 0.9

ADVERTENCIA: Para una óptima disipación del calor, las Magnolias deben ser instaladas verticalmente apuntando hacia arriba.



HIGHPOWER MAGNOLIA 40W / E27 / 90X215mm y 90x220mm					FP	VIDA ÚTIL	MASTER	PRECIO SIN IVA
BTM-40-E27-WW	220°	3000°K	3800lm	95lmxw	0.9	25.000hs	10u.	23,66 USD
BM-40-E27-CW	300°	6500°K	4600lm	115lmxw	0.9	25.000hs	20u.	20,60 USD
								IVA 10,5%



HIGHPOWER MAGNOLIA 40W / E40 / 90X220mm						VIDA ÚTIL	MASTER	PRECIO SIN IVA
BTM-40WW	200°	3000°K	3800lm	95lmxw	0.9	25.000hs	10u.	24,98 USD
								IVA 10,5%



HIGHPOWER MAGNOLIA 60W / E40 / 105X270mm						VIDA ÚTIL	MASTER	PRECIO SIN IVA
BM-60-E40-WW	300°	3000°K	6900lm	115lmxw	0.9	35.000hs	15u.	28,40 USD
BM-60-E40-CW	300°	6500°K	6900lm	115lmxw	0.9	35.000hs	15u.	28,40 USD
								IVA 10,5%



HIGHPOWER MAGNOLIA 80W / E40 / 120X285mm					FP	VIDA ÚTIL	MASTER	PRECIO SIN IVA
BM-80-E40-WW	200°	3000°K	8000lm	100lmxw	0.9	25.000hs	10u.	38,16 USD
BM-80-E40-CW	200°	6000°K	8200lm	102,5lmxw	0.9	25.000hs	10u.	38,16 USD
								IVA 10,5%



HIGHPOWER BULBON LED 60W / E40 / 135X255mm					FP	VIDA ÚTIL	MASTER	PRECIO SIN IVA
BAP-60-E40-WW	200°	3000°K	6000lm	100lmxw	0.9	25.000hs	8u.	19,40 USD
BAP-60-E40-CW	200°	6500°K	6000lm	100lmxw	0.9	25.000hs	8u.	19,40 USD
								IVA 10,5%



HIGHPOWER BULBON LED 90W / E40 / 160X288mm					FP	VIDA ÚTIL	MASTER	PRECIO SIN IVA
BAP-90-E40-WW	200°	3000°K	9000lm	100lmxw	0.9	25.000hs	8u.	23,83 USD
BAP-90-E40-CW	200°	6500°K	9000lm	100lmxw	0.9	25.000hs	8u.	23,83 USD
								IVA 10,5%



LÍNEA DECO GOTA 0.65W / E27 / 80X45mm					VIDA ÚTIL	MASTER	VENTA MINIMA	PRECIO SIN IVA
BFS14-1WW	360°	2700°K	70lm	107,6lm/w	25.000hs	100u.	20u.	1,20 USD
BFS14-1CW	360°	6000°K	70lm	107,6lm/w	25.000hs	100u.	20u.	
IVA 10,5%								



LÍNEA DECO VELA 4W C37 / E14 / 35X100mm					VIDA ÚTIL	MASTER	PRECIO SIN IVA	
BFC37-4WW	360°	2700°K	480lm	120 lm/W	25.000hs	50u.	2,20 USD	
BFC37-4CW	360°	6000°K	505lm	126 lm/W	25.000hs	50u.		
BFC37-E27-4WW	360°	2700°K	490lm	122 lm/W	25.000hs	50u.		
BFC37-E27-4CW	360°	6000°K	515lm	129 lm/W	25.000hs	50u.		
IVA 10,5%								



LÍNEA DECO GOTA 4W G45 / E27 / 45X72mm					VIDA ÚTIL	MASTER	PRECIO SIN IVA	
BFG45-E14-4WW	360°	2700°K	480lm	120 lm/W	25.000hs	50u.	2,25 USD	
BFG45-E14-4CW	360°	6000°K	540lm	135 lm/W	25.000hs	50u.		
BFG45-4WW	360°	2700°K	470lm	117 lm/W	25.000hs	50u.		
BFG45-4CW	360°	6000°K	530lm	132 lm/W	25.000hs	50u.		
IVA 10,5%								



LÍNEA DECO BULBO 6W A60 / E27 / 60X105mm					VIDA ÚTIL	MASTER	PRECIO SIN IVA	
BFA60-6WW	360°	2700°K	800lm	133 lm/W	25.000hs	50u.	3,09 USD	
BFA60-6CW	360°	6000°K	840lm	140 lm/W	25.000hs	50u.		
IVA 10,5%								



LÍNEA DECO BULBO 8W A60 / E27 / 60X105mm					VIDA ÚTIL	MASTER	PRECIO SIN IVA	
BFA60-8WW	360°	2700°K	940lm	117 lm/W	25.000hs	50u.	3,28 USD	
BFA60-8CW	360°	6000°K	1040lm	130 lm/W	25.000hs	50u.		
IVA 10,5%								



LÍNEA DECO VINTAGE DIMERIZABLE 8W ST19 / E27 / 64X140mm					VIDA ÚTIL	MASTER	PRECIO SIN IVA	
DBFST19-8WW	360°	2700°K	875lm	110 lm/W	25.000hs	50u.	5,55 USD	
DBFST19-8CW	360°	6000°K	875lm	110 lm/W	25.000hs	50u.		
IVA 10,5%								



LÍNEA DECO GLOBO DIMERIZABLE 8W G125 / E27 / 125X180mm					VIDA ÚTIL	MASTER	PRECIO SIN IVA	
DBFG125-8WW	360°	2700°K	920lm	115lm/W	25.000hs	20u.	10,23 USD	
DBFG125-8CW	360°	6000°K	920lm	115lm/W	25.000hs	20u.		
IVA 10,5%								



LÍNEA GOLDEN GOTA S14 1W / E27 / 80X45mm					VIDA ÚTIL	MASTER	PRECIO SIN IVA
BFS14G-1WW	360°	2200°K	80lm	80lm/W	25.000hs	20u./100u.	1,83 USD
							IVA 10,5%



LÍNEA GOLDEN BULBO A60 2W / E27 / 105X60mm					VIDA ÚTIL	MASTER	PRECIO SIN IVA
BFA60G-2WW	360°	2200°K	150lm	75lm/W	25.000hs	20u./100u.	5,34 USD

LÍNEA GOLDEN BULBO A60 5W / E27 / 105X60mm					VIDA ÚTIL	MASTER	PRECIO SIN IVA
BFA60G-5WW	360°	2200°K	350lm	70lm/W	25.000hs	20u./100u.	6,67 USD
							IVA 10,5%



LÍNEA GOLDEN VELA C37 3W / E27 / 100X35mm					VIDA ÚTIL	MASTER	PRECIO SIN IVA
BFC37G-3WW	360°	2200°K	240lm	80lm/W	25.000hs	20u./100u.	3,80 USD
							IVA 10,5%



LÍNEA GOLDEN GOTA G45 3W / E27 / 78X45mm					VIDA ÚTIL	MASTER	PRECIO SIN IVA
BFG45G-3WW	360°	2200°K	240lm	80lm/W	25.000hs	20u./100u.	3,69 USD
							IVA 10,5%



LÍNEA GOLDEN TUBO T30 2W / E27 / 30X150mm					VIDA ÚTIL	MASTER	PRECIO SIN IVA
BFT30G-2WW	360°	2200°K	160lm	80lm/W	25.000hs	20u./100u.	7,04 USD

LÍNEA GOLDEN TUBO T30 5W / E27 / 30X150mm					VIDA ÚTIL	MASTER	PRECIO SIN IVA
BFT30G-5WW	360°	2200°K	260lm	52lm/W	25.000hs	50u.	7,35 USD
							IVA 10,5%



LÍNEA GOLDEN TUBO T45 4W / E27 / 45X110mm					VIDA ÚTIL	MASTER	PRECIO SIN IVA
BFT45G-4WW	360°	2200°K	240lm	60lm/W	25.000hs	20u./100u.	5,80 USD
							IVA 10,5%



LÍNEA GOLDEN VINTAGE ST19 2W / E27 / 146X64mm					VIDA ÚTIL	MASTER	PRECIO SIN IVA
BFST19G-2WW	360°	2200°K	150lm	75lm/W	25.000hs	20u./100u.	6,11 USD

LÍNEA GOLDEN VINTAGE ST19 5W / E27 / 146X64mm					VIDA ÚTIL	MASTER	PRECIO SIN IVA
BFST19-5WW	360°	2200°K	260lm	52lm/W	25.000hs	50u.	6,04 USD
							IVA 10,5%



LÍNEA GOLDEN GLOBO 5W / E27 / 125X175mm					VIDA ÚTIL	MASTER	PRECIO SIN IVA
BFG95G-5WW	360°	2200°K	260lm	52lm/W	25.000hs	24u.	9,94 USD

BFG125-5WW	360°	2200°K	260lm	52lm/W	25.000hs	20u.	10,53 USD
							IVA 10,5%



LÍNEA FILAMENTO DECO COLOR GOTA 1W / E27 / 80X45mm				MATERIAL	VIDA ÚTIL	MASTER	VENTA MÍNIMA	PRECIO SIN IVA
BFS14 - 1A	360°	Azul	460 NM	Vidrio Translucido	25.000hs	100u.	20u.	1,20 USD
BFS14- 1R	360°	Rojo	625 NM	Vidrio Translucido	25.000hs	100u.	20u.	
BFS14- 1V	360°	Verde	520 NM	Vidrio Translucido	25.000hs	100u.	20u.	
BFS14- 1Y	360°	Amarillo	585 NM	Vidrio Translucido	25.000hs	100u.	20u.	
IVA 10,5%								



LÍNEA FILAMENTO DECO COLOR BULBO 4W / E27 / 60X105mm				MATERIAL	VIDA ÚTIL	MASTER	VENTA MÍNIMA	PRECIO SIN IVA
BFA60- 4A	360°	Azul	460 NM	Vidrio Translucido	25.000hs	100u.	10u.	2,88 USD
BFA60- 4R	360°	Rojo	625 NM	Vidrio Translucido	25.000hs	100u.	10u.	
BFA60- 4V	360°	Verde	520 NM	Vidrio Translucido	25.000hs	100u.	10u.	
BFA60- 4Y	360°	Amarillo	585 NM	Vidrio Translucido	25.000hs	100u.	10u.	
IVA 10,5%								



PAR 30 12W / E27 / 95x119mm / Vidrio					VIDA ÚTIL	INTERMEDIA	MASTER	PRECIO SIN IVA
PAR30-V-12-40G-WW	40°	2700°K	1200lm	100lm/W	19.000hs	6u.	24u.	12,47 USD IVA 10,5%



PAR 30 24.5W / E27 / 95x125mm / Aluminio					VIDA ÚTIL	MASTER	PRECIO SIN IVA
PAR30-AL-30-30G-WW	24°	2700°K	3000lm	123lm/W	50.000hs	24u.	15,00 USD IVA 10,5%



PAR 30 11W / IP65 / E27 / 92x86mm / PVC					VIDA ÚTIL	MASTER	PRECIO SIN IVA
PAR30-11-E27-WW	38°	3000°K	950lm	86 lm/W	25.000hs	20u.	9,00 USD IVA 10,5%
PAR30-11-E27-CW	38°	6500°K	1000lm	90 lm/W	25.000hs	20u.	



PAR 38 18W / IP65 / E27 / 120x135mm / PVC					VIDA ÚTIL	MASTER	PRECIO SIN IVA
PAR38-20-E27-WW	38°	3000°K	1400lm	77,7 lm/W	25.000hs	20u.	14,22 USD IVA 10,5%
PAR38-20-E27-CW	38°	6500°K	1400lm	77,7 lm/W	25.000hs	20u.	

NUEVO SKU, MISMO PRODUCTO



PAR16 5W PVC 120° / GU10 / Ø50x49mm					VIDA ÚTIL	MASTER	PRECIO SIN IVA	
◆	PAR16-PVCB-5W-120D-WW	120°	2700°K	540lm	108lm/W	25.000hs	100u.	1,11 USD
◆	PAR16-PVCB-5W-120D-NW	120°	4500°K	540lm	108lm/W	25.000hs	100u.	
◆	PAR16-PVCB-5W-120D-CW	120°	6500°K	540lm	108lm/W	25.000hs	100u.	
							IVA 10,5%	



PAR16 7W PVC / GU10 / 59x50x50mm					VIDA ÚTIL	MASTER	PRECIO SIN IVA	
◆	PAR16-PVCB-7W-38D-WW	38°	2700°K	595lm	85lm/W	25.000hs	100u.	1,52 USD
◆	PAR16-PVCB-7W-38D-NW	38°	4500°K	595lm	85lm/W	25.000hs	100u.	
◆	PAR16-PVCB-7W-38D-CW	38°	6500°K	595lm	85lm/W	25.000hs	100u.	
							IVA 10,5%	



PAR16 7W PVC DIMERIZABLE / GU10 / 59x50x50mm					VIDA ÚTIL	MASTER	PRECIO SIN IVA	
◆	PAR16-PVCB-7W-38D-DIMWW	38°	2700°K	595lm	85lm/W	25.000hs	100u.	2,88 USD
◆	PAR16-PVCB-7W-38D-DIMNW	38°	4500°K	595lm	85lm/W	25.000hs	100u.	
◆	PAR16-PVCB-7W-38D-DIMCW	38°	6500°K	595lm	85lm/W	25.000hs	100u.	
							IVA 10,5%	



PAR16 7W PVC NEGRA / GU10 / 59x50x50mm					VIDA ÚTIL	MASTER	PRECIO SIN IVA	
◆	PAR16-PVCN-7W-38D-WW	38°	2700°K	595lm	85lm/W	25.000hs	100u.	1,67 USD
◆	PAR16-PVCN-7W-38D-NW	38°	4500°K	595lm	85lm/W	25.000hs	100u.	
◆	PAR16-PVCN-7W-38D-CW	38°	6500°K	595lm	85lm/W	25.000hs	100u.	
							IVA 10,5%	



Bridgelux
Led marca líder en el mercado



6.5W

*Compatible con dimmer apto LED.



PAR16-AL-6.5W-DIM / GU10 / ø50x54mm					VIDA ÚTIL	INTER/MASTER	PRECIO SIN IVA
PAR16-AL-6.5W-DIM-12D	12°	2700°K	585lm	90 lm/W	50.000hs	20u. / 100u.	8,21 USD
PAR16-AL-6.5W-DIM-24D	24°	2700°K	585lm	90 lm/W	50.000hs	20u. / 100u.	6,97 USD
PAR16-AL-6.5W-DIM-36D	36°	2700°K	585lm	90 lm/W	50.000hs	20u. / 100u.	
							IVA 10,5%



7.2W / 7W

*Compatible con dimmer apto LED.



PAR16-V-7W-36D / GU10 / ø50x54mm					VIDA ÚTIL	MASTER/VENTAMÍN.	PRECIO SIN IVA
PAR16-V-7W-36D-DIM-WW	36°	2700°K	540lm	75 lm/W	15.000hs	10u. / 80u.	2,70 USD
PAR16-V-7W-36D-DIM-CW	36°	6500°K	540lm	75 lm/W	15.000hs	10u. / 80u.	
PAR16-V-7W-36D-WW	36°	2700°K	600lm	85 lm/W	25.000hs	10u. / 80u.	2,20 USD
PAR16-V-7W-36D-CW	36°	6500°K	600lm	85 lm/W	25.000hs	10u. / 80u.	
							IVA 10,5%

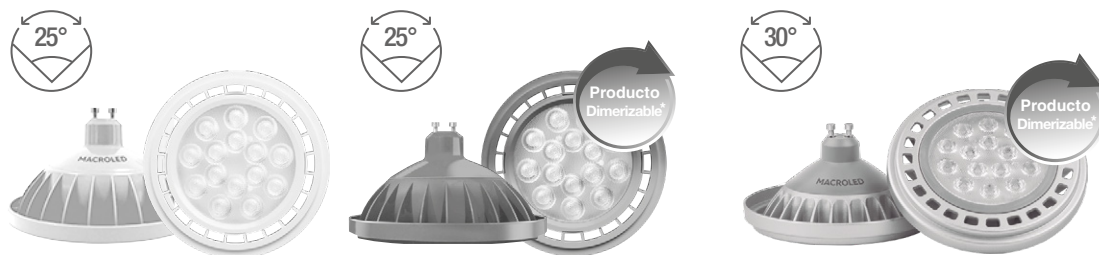

Carcasa Premium
de Aluminio



AR111 11W PVC / GU10 / 111x65mm					VIDA ÚTIL	MASTER	PRECIO SIN IVA
ND111-11-WW	25°	2700°K	980lm	89 lm/W	25.000hs	50u.	5,02 USD
ND111-11-CW	25°	6500°K	990lm	90 lm/W	25.000hs	50u.	
							IVA 10,5%



AR111 11W PVC BLANCA / GU10 / 111x65mm					VIDA ÚTIL	MASTER	PRECIO SIN IVA
BND111-11-WW	25°	2700°K	980lm	89 lm/W	25.000hs	50u.	4,82 USD
BND111-11-CW	25°	6500°K	990lm	90 lm/W	25.000hs	50u.	
							IVA 10,5%



AR111 15W PVC / GU10 / 111x65mm					VIDA ÚTIL	MASTER	PRECIO SIN IVA
ND111-15-WW	25°	2700°K	980lm	89 lm/W	25.000hs	50u.	5,12 USD
ND111-15-CW	25°	6500°K	990lm	90 lm/W	25.000hs	50u.	
							IVA 10,5%



AR111 15W PVC BLANCA / GU10 / 111x65mm					VIDA ÚTIL	MASTER	PRECIO SIN IVA
BND111-15-WW	25°	2700°K	980lm	89 lm/W	25.000hs	50u.	4,97 USD
BND111-15-CW	25°	6500°K	990lm	90 lm/W	25.000hs	50u.	
							IVA 10,5%



AR111 15W PVC DIMERIZABLE / GU10 / 111x65mm					VIDA ÚTIL	MASTER	PRECIO SIN IVA
ES111-15-WW	25°	2700°K	980lm	89 lm/W	25.000hs	50u.	6,73 USD
ES111-15-CW	25°	6500°K	990lm	90 lm/W	25.000hs	50u.	
							IVA 10,5%



AR111 15W ALUMINIO DIMERIZABLE / GU10 / 111x61mm					VIDA ÚTIL	MASTER	PRECIO SIN IVA
D-111-GU10-WW	30°	2700°K	1380lm	92lm/W	40000hs	50u.	15,82 USD
D-111-GU10-CW	30°	6500°K	1425lm	95lm/W	40000hs	50u.	
							IVA 10,5%

MATERIAL

ACRÍLICO FOCAL
+ ALUMINIO

- CRI ≥93Ra**
Colores más vivos y con más intensidad.
- LED BRIDGELUX**
Con led Bridgelux, marca líder en el mercado.
- SPD 3000V**
Protección contra sobretensiones
- DIMMER TRIAC**
Compatible con cualquier dimmer.

3
AÑOS
GARANTÍA

Ángulo de Apertura

8°

24°

Advertencias: La lámpara debe ser instalada verticalmente en artefactos abiertos en óptimas condiciones.

	AR111 PRO 11W DIMERIZABLE 8° / GU10 / 92x111mm					VIDA ÚTIL	MASTER	PRECIO SIN IVA
	AR111-12W-8-DIM-WW	Cálido	2700°K	600lm	54,5 lm/W	30000hs	20u.	39,00 USD
								IVA 10,5%

	AR111 PRO 11W DIMERIZABLE 24° / GU10 / 92x111mm					VIDA ÚTIL	MASTER	PRECIO SIN IVA
	AR111-12W-24-DIM-WW	Cálido	2700°K	600lm	54,5 lm/W	30000hs	20u.	39,00 USD
								IVA 10,5%

MATERIAL

PA+PC

- Multivoltaje**
AC100-240V
- SPD 500V**

2
AÑOS
GARANTÍA

Ángulo de Apertura	Tipo LED	Temperatura de color	DIM
12°	COB Samsung	2700	X
		4000	X
24°	SMD	2700	X
		4000	X
		2700	✓

	AR111-C-11W-12D / GU10 / ø110 x 75,5mm					VIDA ÚTIL	MASTER/VENTA MÍN.	PRECIO SIN IVA
	AR111-C-11W-12DWW	Cálido	2700°K	950lm	86lm x/W	25000hs	4u. / 24u.	8,740 USD
	AR111-C-11W-12DNW	Neutro	4000°K	950lm	86lm x/W	25000hs	4u. / 24u.	
							IVA 10,5%	

	AR111-FC-10W-24D / GU10 / ø110x75,5mm					VIDA ÚTIL	MASTER/VENTA MÍN.	PRECIO SIN IVA
	AR111-FC-10W-24DWW	Cálido	2700°K	950lm	95lm x/W	25000hs	4u. / 24u.	7,640 USD
	AR111-FC-10W-24DNW	Neutro	4000°K	950lm	95lm x/W	25000hs	4u. / 24u.	
							IVA 10,5%	

	AR111-DIM-FC-11W-24D / ø110 x 75,5mm					VIDA ÚTIL	MASTER/VENTA MÍN.	PRECIO SIN IVA
	AR111-DIM-FC-11W-24DWW	Cálido	2700°K	950lm	86lm x/W	25000hs	4u. / 24u.	9,750 USD
								IVA 10,5%

MATERIAL

ACRÍLICO FOCAL
+ ALUMINIO

Disipador
de Aluminio





CRI ≥93Ra
Colores más vivos y con más intensidad.

LED BRIDGELUX
Con led Bridgelux, marca líder en el mercado.

SPD 3000V
Protección contra sobretensiones

DIMMER TRIAC
Compatible con cualquier dimmer.

2 AÑOS
GARANTÍA

12°
Ángulo de Apertura

24°
Ángulo de Apertura

Advertencias: La lámpara debe ser instalada verticalmente en artefactos abiertos en óptimas condiciones.



MR16 PRO 5W DIMERIZABLE 12° / GU10 / 64x49mm					VIDA ÚTIL	MASTER	PRECIO SIN IVA
MR16-5W-12G-DIM-WW	Cálido	2700°K	250lm	50 lm/W	30000hs	50u.	18,73 USD IVA 10,5%



MR16 PRO 5W DIMERIZABLE 24° / GU10 / 64x49mm					VIDA ÚTIL	MASTER	PRECIO SIN IVA
MR16-5W-24G-DIM-WW	Cálido	2700°K	250lm	50 lm/W	30000hs	50u.	18,73 USD IVA 10,5%



BIPIN G9 4,5W / 15X50mm					VIDA ÚTIL	INTER / MASTER	PRECIO SIN IVA
G9-4.5-WW	360°	2700°K	390lm	86 lm/W	25.000hs	100u. / 600u.	2,41 USD
G9-4.5-CW	360°	6000°K	390lm	86 lm/W	25.000hs	100u. / 600u.	
							IVA 10,5%



BIPIN G9 6W / 15X60mm					VIDA ÚTIL	INTER / MASTER	PRECIO SIN IVA
G9-6-WW	360°	2700°K	570lm	95 lm/W	25.000hs	100u. / 600u.	3,02 USD
G9-6-CW	360°	6000°K	570lm	95 lm/W	25.000hs	100u. / 600u.	
							IVA 10,5%



BIPIN G9 9W / 20X64mm					VIDA ÚTIL	INTER / MASTER	PRECIO SIN IVA
G9-9-WW	360°	2700°K	900lm	100 lm/W	25.000hs	100u. / 400u.	4,54 USD
G9-9-CW	360°	6000°K	900lm	100 lm/W	25.000hs	100u. / 400u.	
							IVA 10,5%



BIPIN G9 12W / 24X66mm					VIDA ÚTIL	INTER / MASTER	PRECIO SIN IVA
G9-12WW	360°	2700°K	1200lm	100 lm/W	25.000hs	100u. / 400u.	5,11 USD
G9-12CW	360°	6000°K	1200lm	100 lm/W	25.000hs	100u. / 400u.	
							IVA 10,5%



BIPIN G4 2W / 12V / 16x36mm					VIDA ÚTIL	INTER / MASTER	PRECIO SIN IVA
G4-2WW	360°	2700°K	200lm	100 lm/W	25.000hs	100u. / 600u.	2,55 USD
G4-2CW	360°	6000°K	200lm	100 lm/W	25.000hs	100u. / 600u.	
							IVA 10,5%



BIPIN G4 4W / 12V / 16x56mm					VIDA ÚTIL	INTER / MASTER	PRECIO SIN IVA
G4-4WW	360°	2700°K	420lm	105 lm/W	25.000hs	100u. / 600u.	3,36 USD
G4-4CW	360°	6000°K	420lm	105 lm/W	25.000hs	100u. / 600u.	
							IVA 10,5%



BIPIN G9 5W OPAL / 16x60mm					VIDA ÚTIL	INTER / MASTER	PRECIO SIN IVA
G9-OP-5-WW	360°	2700°K	460lm	92 lm/W	25.000hs	100u. / 600u.	2,43 USD
G9-OP-5-CW	360°	6000°K	460lm	92 lm/W	25.000hs	100u. / 600u.	
							IVA 10,5%



BIPIN G4 2,5W OPAL / 220V-240V / 16x45mm					VIDA ÚTIL	INTER / MASTER	PRECIO SIN IVA
G4-OP-220-2.5-WW	360°	2700°K	190lm	76 lm/W	25.000hs	100u./1000u.	2,00 USD
G4-OP-220-2.5-CW	360°	6000°K	190lm	76 lm/W	25.000hs	100u./1000u.	
							IVA 10,5%



GUIRNALDA LARGA E27	LARGO	CANT. DE CONECTORES	POTENCIA	PROTECCIÓN	MASTER	
GUIR-5MT-E27	5 m.	10	700W Máx.	IP66	10u.	40,80 USD
GUIR-10MT-E27	10 m.	20	700W Máx.	IP66	8u.	60,00 USD
						IVA 21%

GUIRNALDA CORTA E27	LARGO	CANT. DE CONECTORES	POTENCIA	PROTECCIÓN	MASTER	
GUIRC-5MT-E27	5 m.	10	700W Máx.	IP66	10u.	38,70 USD
GUIRC-10MT-E27	10 m.	20	700W Máx.	IP66	8u.	71,50 USD
						IVA 21%



VINTAGE



VINTAGE/
CON PERILLA



JERSEY



NASHVILLE



DIXON



VANCOUVER



Portalámparas Nashville E27		POTENCIA MÁX	CONECTOR	TENSIÓN	MASTER	VENTA MIN.	PRECIO SIN IVA
PLV-NAS-E27-CO	Cobre	60W Máx.	E27	250V Máx.	100u.	10u.	7,52 USD
PLV-NAS-E27-BR	Bronce	60W Máx.	E27	250V Máx.	100u.	10u.	
PLV-NAS-E27-BB	Bronce Brillante	60W Máx.	E27	250V Máx.	100u.	10u.	
							IVA 21%



Portalámparas Vintage E27		POTENCIA MÁX	CONECTOR	TENSIÓN	MASTER	VENTA MIN.	PRECIO SIN IVA
PLV-VIN-E27-CO	Cobre	60W Máx.	E27	250V Máx.	100u.	10u.	5,64 USD
PLV-VIN-E27-BR	Bronce	60W Máx.	E27	250V Máx.	100u.	10u.	
PLV-VIN-E27-BB	Bronce Brillante	60W Máx.	E27	250V Máx.	100u.	10u.	
							IVA 21%



Portalámparas Vintage con Perilla E27		POTENCIA MÁX	CONECTOR	TENSIÓN	MASTER	VENTA MIN.	PRECIO SIN IVA
PLV-VIN-P-E27-CO	Cobre	60W Máx.	E27	250V Máx.	100u.	10u.	6,73 USD
PLV-VIN-P-E27-BR	Bronce	60W Máx.	E27	250V Máx.	100u.	10u.	
PLV-VIN-P-E27-BB	Bronce Brillante	60W Máx.	E27	250V Máx.	100u.	10u.	
							IVA 21%



Portalámparas Dixon E27		POTENCIA MÁX	CONECTOR	TENSIÓN	MASTER	VENTA MIN.	PRECIO SIN IVA
PLV-DIX-E27-CO	Cobre	60W Máx.	E27	250V Máx.	100u.	10u.	6,81 USD
PLV-DIX-E27-BR	Bronce	60W Máx.	E27	250V Máx.	100u.	10u.	
PLV-DIX-E27-BB	Bronce Brillante	60W Máx.	E27	250V Máx.	100u.	10u.	
							IVA 21%



Portalámparas Jersey E27		POTENCIA MÁX	CONECTOR	TENSIÓN	MASTER	VENTA MIN.	PRECIO SIN IVA
PLV-JER-E27-CO	Cobre	60W Máx.	E27	250V Máx.	100u.	10u.	5,19 USD
PLV-JER-E27-BR	Bronce	60W Máx.	E27	250V Máx.	100u.	10u.	
PLV-JER-E27-BB	Bronce Brillante	60W Máx.	E27	250V Máx.	100u.	10u.	
							IVA 21%



Portalámparas Vancouver E27		POTENCIA MÁX	CONECTOR	TENSIÓN	MASTER	VENTA MIN.	PRECIO SIN IVA
PLV-VAN-E27-NE	Negro	60W Máx.	E27	250V Máx.	100u.	10u.	7,98 USD
PLV-VAN-E27-CR	Cromo	60W Máx.	E27	250V Máx.	100u.	10u.	
PLV-VAN-E27-CO	Cobre	60W Máx.	E27	250V Máx.	100u.	10u.	
							IVA 21%



CAB-TEX-BR-100



CAB-TEX-ND-50



CAB-TEX-MG-100



CAB-TEX-BN-100

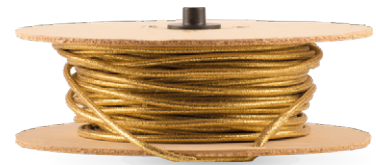

CAB-TEX-DD-50

Todos los modelos de cables textiles, son productos normalizados.

Cables Textiles	SECCIÓN	TENSIÓN	CARRETEL xMTS	COLOR	VENTA MINIMA	PRECIO SIN IVA
CAB-TEX-BR-100	0,5MM2	300V	x100	Bronce	1u.	96,44 USD
CAB-TEX-ND-50	0,5MM2	300V	x50	Negro con Dorado Zig Zag	1u.	75,91 USD
CAB-TEX-MG-100	0,5MM2	300V	x100	Manteca con Gris	1u.	96,44 USD
CAB-TEX-BN-100	0,5MM2	300V	x100	Blanco y Negro Zig Zag	1u.	96,44 USD
CAB-TEX-DD-50	0,5MM2	300V	x50	Dorado	1u.	75,91 USD
						IVA 21%



PL-E27



PL-E27-ES



PL-E27-PU



PL-E27-RO



PL-E40



GU5.3

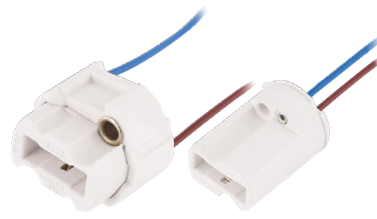

GU9 / CON CABLE



K512GU

Portalámparas Cerámico E27	CARACTERÍSTICAS	POTENCIA MÁX.	CONECTOR	TENSIÓN	MASTER	VENTA MIN.	PRECIO SIN IVA
PL-E27	-	1000W Máx.	E27	250V Máx.	100u.	20u.	0,73 USD
PL-E27-PU	Con Puente	1000W Máx.	E27	250V Máx.	100u.	20u.	0,90 USD
PL-E27-ES	Con Escuadra	1000W Máx.	E27	250V Máx.	100u.	20u.	0,92 USD

IVA 21%

Portalámparas Plástico E27	CARACTERÍSTICAS	POTENCIA MÁX.	CONECTOR	TENSIÓN	MASTER	VENTA MIN.	PRECIO SIN IVA
PL-E27-RO	Rosca Exterior con Aro	60W Máx.	E27	750V Máx.	100u.	20u.	0,87 USD

IVA 21%

Portalámparas Cerámico E40	CARACTERÍSTICAS	POTENCIA MÁX.	CONECTOR	TENSIÓN	MASTER	VENTA MIN.	PRECIO SIN IVA
PL-E40	-	3000W Máx.	E40	250V Máx.	100u.	20u.	2,56 USD

IVA 21%

Conector Cerámico GU5.3	CARACTERÍSTICAS	POTENCIA MÁX.	CONECTOR	TENSIÓN	MASTER	VENTA MIN.	PRECIO SIN IVA
CON-GU5.3-CAB	Cable Entelado (15cm)	40W Máx.	GU5.3	250V Máx.	500u.	20u.	0,43 USD

IVA 21%

Portalámparas Cerámico G9	CARACTERÍSTICAS	POTENCIA MÁX.	CONECTOR	TENSIÓN	MASTER	VENTA MIN.	PRECIO SIN IVA
CON-G9	-	100W Máx.	G9	250V Máx.	500u.	50u.	1,20 USD
CON-G9-CAB	Con Cable (15cm)	100W Máx.	G9	250V Máx.	500u.	50u.	0,66 USD

IVA 21%

Conector Cerámico GU10	CARACTERÍSTICAS	POTENCIA MÁX.	CONECTOR	TENSIÓN	MASTER	PRECIO SIN IVA
K512GU	Cable Entelado (20cm)	100W Máx.	GU10	750V Máx.	500u.	0,51 USD

IVA 21%

Incluye conector GU10



MATERIAL

METAL

Artefactos compatibles con lámparas de Ø50 mm.

EMBUTIR MR16 FIJO 8mm	COLOR	LÁMPARAS	DIMENSIONES	CORTE	MASTER	PRECIO SIN IVA
ADF-D8-BCO	○ Blanco	DICRO 50mm	Ø80mm	Ø60mm	200u.	1,25 USD IVA 21%

EMBUTIR MR16 MÓVIL 8mm	COLOR	LÁMPARAS	DIMENSIONES	CORTE	MASTER	PRECIO SIN IVA
ADM-D8-BCO	○ Blanco	DICRO 50mm	Ø83mm	Ø65mm	100u.	1,72 USD
ADM-D8-NEG	● Negro	DICRO 50mm	Ø83mm	Ø65mm	100u.	1,72 USD
ADM-D8-PLA	● Platil	DICRO 50mm	Ø83mm	Ø65mm	100u.	2,52 USD IVA 21%

EMBUTIR MR16 MÓVIL 10mm	COLOR	LÁMPARAS	DIMENSIONES	CORTE	MASTER	PRECIO SIN IVA
ADM-D10-BCO-CO	○ Blanco	DICRO 50mm	Ø100mm	Ø80mm	100u.	2,60 USD
ADM-D10-NEG-CO	● Negro	DICRO 50mm	Ø100mm	Ø80mm	100u.	2,60 USD
ADM-D10-PLA-CO	● Platil	DICRO 50mm	Ø100mm	Ø80mm	100u.	3,55 USD IVA 21%

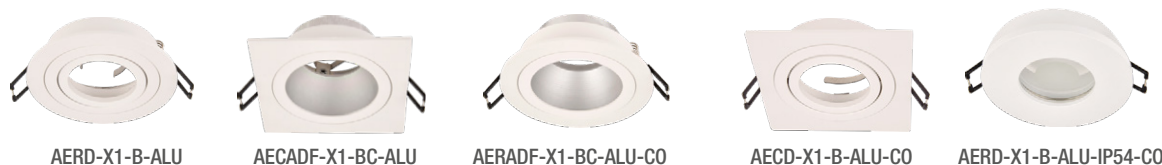

MATERIAL

ALUMINIO

EMBUTIR ALUMINIO IP54	COLOR	COMPATIBILIDAD	DIMENSIONES	CORTE	INTER/MASTER	PRECIO SIN IVA
ADF-D8-BCO	○ Blanco	Circular	Ø85x30mm	Ø60mm	10U./ 100u.	9,91 USD IVA 21%

ANTIDSLUMBRANTE FIJO	COLOR	COMPATIBILIDAD	DIMENSIONES	CORTE	INTER/MASTER	PRECIO SIN IVA
AECADF-X1-BC-ALU	○ Blanco	Cuadrado	93x93x35mm	Ø80mm	10u. / 100u.	9,35 USD
AERADF-X1-BC-ALU-CO	○ Blanco	Circular	93x93x35mm	Ø80mm	10u. / 100u..	9,26 USD IVA 21%

EMBUTIR ALUMINIO MÓVIL	COLOR	COMPATIBILIDAD	DIMENSIONES	CORTE	INTER/MASTER	PRECIO SIN IVA
AECD-X1-B-ALU-CO	○ Blanco	Cuadrado	94x94x25mm	Ø75mm	10u. / 100u.	7,86 USD
AERD-X1-B-ALU-CO	○ Blanco	Circular	Ø94x25mm	Ø75mm	10u. / 100u..	7,86 USD IVA 21%

Incluye conector GU10

MATERIAL
METAL



- Móvil de 1 eje
- Fácil de Colocar
- Embutidos con guía para colocar
- Acabado satinado

Artefactos compatibles con lámparas de Ø50 mm.

EMBUTIR MÓVIL MR16	COLOR	SPOT	COMPATIBLE	DIMENSIONES	CORTE	MASTER	PRECIO SIN IVA
● AED-X1-MB-CO	Blanco	x1	DICRO	100x100x37	85x85	50u.	4,63 USD
● AED-X1-MN-CO	● Negro	x1	DICRO	100x100x37	85x85	50u.	
● AED-X2-MB-CO	Blanco	x2	DICRO	185x100x37	170x85	20u.	9,24 USD
AED-X2-MN	● Negro	x2	DICRO	185x100x37	170x85	20u.	
AED-X3-MB	Blanco	x3	DICRO	270x100x37	255x85	20u.	13,88 USD
							IVA 21%

MATERIAL
METAL



- Plafón Compatible con cajas octogonales homologadas chicas 8cm y grandes 10cm

PLAFÓN CARDANICO MR16	COLOR	SPOT	COMPATIBLE	DIMENSIONES	MASTER	PRECIO SIN IVA
APCD-X1-CB	Blanco	x1	DICRO	134x134x106	20u.	13,90 USD
APCD-X1-CN	● Negro	x1	DICRO	134x134x106	20u.	
APCD-X2-CB	Blanco	x2	DICRO	228x135x100	12u.	18,74 USD
APCD-X2-CN	● Negro	x2	DICRO	228x135x100	12u.	
APCD-X4-CB	Blanco	x4	DICRO	225x225x106	6u.	51,97 USD
APCD-X4-CN	● Negro	x4	DICRO	225x225x106	6u.	
						IVA 21%

Incluye conector GU10

MATERIAL
METAL



- Doble Direccionamiento
 - Fácil de Colocar
 - Embutidos con guia para colocar
 - Acabado satinado
- Artefactos compatibles con lámparas de Ø111 mm.

EMBUTIR CARDANICO AR111	COLOR	SPOT	COMPATIBLE	DIMENSIONES	CORTE	MASTER	PRECIO SIN IVA
● AECAR-X1-MB-CO	○ Blanco	x1	AR111	182x182x40	165x165	20u.	6,85 USD
● AECAR-X1-MN-CO	● Negro	x1	AR111	182x182x40	165x165	20u.	
● AECAR-X2-MB-CO	○ Blanco	x2	AR111	182x332x40	165x300	12u.	11,85 USD
● AECAR-X2-MN-CO	● Negro	x2	AR111	185x100x37	165x300	12u.	
AECAR-X3-MB	○ Blanco	x3	AR111	182x482x40	178x475	12u.	18,23 USD
● AECAR-X3-MN-CO	● Negro	x3	AR111	182x482x40	178x475	12u.	
							IVA 21%

MATERIAL
METAL



- Plafón Compatible con cajas octogonales homologadas chicas 8cm y grandes 10cm

EMBUTIR CARDANICO AR111	COLOR	SPOT	COMPATIBLE	DIMENSIONES	MASTER	PRECIO SIN IVA
APCAR-X1-CB	○ Blanco	x1	AR111	185x185x110	12u.	25,20 USD
APCAR-X1-CN	● Negro	x1	AR111	185x185x110	12u.	
APCAR-X2-CB	○ Blanco	x2	AR111	335x185x110	8u.	37,99 USD
APCAR-X2-CN	● Negro	x2	AR111	335x185x110	8u..	
APCAR-X4-CB	○ Blanco	x4	AR111	335x335x110	6u.	68,01 USD
APCAR-X4-CN	● Negro	x4	AR111	335x335x110	6u.	
						IVA 21%

PLAFÓN CARDANICO AR111	COLOR	SPOT	COMPATIBLE	DIMENSIONES	MASTER	PRECIO SIN IVA
APCAR-X1-CB-ALT	○ Blanco	x1	AR111	185x185x150	12u.	10,00 USD
APCAR-X2-CB-ALT	○ Blanco	x2	AR111	335x185x150	8u.	20,00 USD
APCAR-X4-CB-ALT	○ Blanco	x4	AR111	335x335x150	6u.	40,00 USD
						IVA 21%

Incluye conector GU10

MATERIAL
PC



AERAD-X1-BB-PC



AERAD-X1-NN-PC



AERAD-X1-BC-PC



AERAD-X1-NC-PC



AERAD-X1-BC-PC

Artefactos compatibles con lámparas de Ø50 mm.

ANTIDESLUMBRANTE MOVIL PC	COLOR	COMPATIBLE	DIMENSIONES	CORTE	INTER / MASTER	PRECIO SIN IVA
AERAD-X1-BB-PC	○ ○ Blanco-Blanco	1xGU10	85*85*32	Ø75	20u. / 100u.	1,84 USD
AERAD-X1-BN-PC	○ ● Blanco-Negro	1xGU10	85*85*32	Ø75	20u. / 100u.	
AERAD-X1-NN-PC-CO	● ● Negro-Negro	1xGU10	85*85*32	Ø75	20u. / 100u.	2,48 USD
AERAD-X1-BC-PC	○ ○ Blanco-Cromo	1xGU10	85*85*32	Ø75	20u. / 100u.	
AERAD-X1-NC-PC	● ○ Negro-Cromo	1xGU10	85*85*32	Ø75	20u. / 100u.	2,65 USD
						IVA 21%

MATERIAL
PC



AERADFR-X1-B-PC



AERAD-X1-BB-PC-TEX



AERADFC-X1-B-PC



AERDAC-X1-B-PC



AERDAC-X1-N-PC



AERDF-X1-B-PC



AERD-X1-B-PC



MOVIL PC	COLOR	COMPATIBLE	DIMENSIONES	CORTE	INTER / MASTER	PRECIO SIN IVA
AERD-X1-B-PC	○ Blanco	1xGU10	Ø90*25	Ø75	20u. / 100u.	2,30 USD
						IVA 21%

MOVIL PC	COLOR	COMPATIBLE	DIMENSIONES	CORTE	INTER / MASTER	PRECIO SIN IVA
AERAD-X1-BB-PC-TEX-CO	○ Blanco	1xGU10	Ø90*34	Ø75	20u. / 100u..	2,54 USD
						IVA 21%

MOVIL PC	COLOR	COMPATIBLE	DIMENSIONES	CORTE	INTER / MASTER	PRECIO SIN IVA
AERDF-X1-B-PC	○ Blanco	1xGU10	Ø86*40	Ø50	20u. / 100u.	2,47 USD
						IVA 21%

MOVIL PC	COLOR	COMPATIBLE	DIMENSIONES	CORTE	INTER / MASTER	PRECIO SIN IVA
AERADFC-X1-B-PC	○ Blanco	1xGU10	Ø86*40	Ø50	20u. / 100u.	2,23 USD
						IVA 21%

MOVIL PC	COLOR	COMPATIBLE	DIMENSIONES	CORTE	INTER / MASTER	PRECIO SIN IVA
AERADFR-X1-B-PC	○ Blanco	1xGU10	Ø86*40	Ø85*35	20u. / 100u.	2,15 USD
						IVA 21%

MOVIL PC	COLOR	COMPATIBLE	DIMENSIONES	CORTE	INTER / MASTER	PRECIO SIN IVA
AERDAC-X1-B-PC	○ Blanco	1xGU10	Ø88*32	Ø75	20u. / 100u.	2,50 USD
AERDAC-X1-N-PC	● Negro	1xGU10	Ø88*32	Ø75	20u. / 100u.	
						IVA 21%



MATERIAL
PC



Artefactos compatibles con lámparas de Ø50mm.

ANTIDSLUMBRANTE MOVIL PC		COMPATIBLE	DIMENSIONES	CORTE	INTER / MASTER	PRECIO SIN IVA
AECAD-X2-B-PC	● Blanco	2xGU10	220*113*34	100*200	10u. / 50u.	8,40 USD
AECAD-X2-N-PC	● Negro	2xGU10	220*113*34	100*200	10u. / 50u.	
AECAD-X3-B-PC	● Blanco	3xGU10	326*113*34	100*300	5u. / 50u.	12,11 USD
AECAD-X3-N-PC	● Negro	3xGU10	326*113*34	100*300	5u. / 50u.	
						IVA 21%

MATERIAL
PC



EMBITUR CUADRADO MÓVIL PC		COMPATIBLE	DIMENSIONES	CORTE	INTER / MASTER	PRECIO SIN IVA
AECD-X1-B-PC	● Blanco	1xGU10	93*93*25	Ø75	20u. / 100u.	2,79 USD
AECD-X2-B-PC	○ Blanco	2xGU10	173x93x25	Ø75	10u. / 50u.	6,04 USD
AECD-X2-N-PC	● Negro	2xGU10	173x93x25	Ø75	10u. / 50u.	
AECD-X3-B-PC	○ Blanco	3xGU10	252x93x25	Ø75	5u. / 50u.	8,14 USD
AECD-X3-N-PC	● Negro	3xGU10	252x93x25	Ø75	5u. / 50u.	
						IVA 21%



MATERIAL

PC

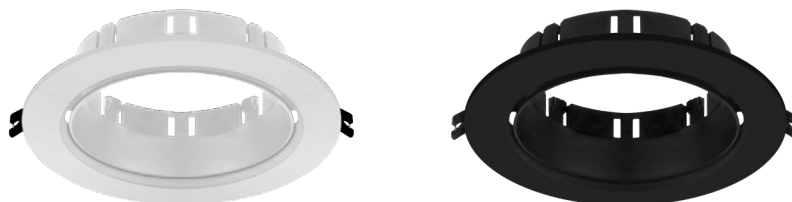

ANTIDESLUMBRANTE MÓVIL 1 EJE PC / REDONDO		COMPATIBLE	DIMENSIONES	CORTE	INTER / MASTER	PRECIO SIN IVA
AERA-AR-X1-B-PC	● Blanco	1xAR111	165*165*43	135*155	10u. / 40u.	7,19 USD IVA 21%
AERA-AR-X1-N-PC	● Negro	1xAR111	165*165*43	135*155	10u. / 40u.	

MATERIAL

PC



8,65 USD

IVA 21%

ANTIDESLUMBRANTE MÓVIL 1 EJE PC / CUADRADO		COMPATIBLE	DIMENSIONES	CORTE	INTER / MASTER	PRECIO SIN IVA
AECA-AR-X1-B-PC	● Blanco	1xAR111	165*165*41	135*155	10u. / 40u.	7,67 USD IVA 21%
AECA-AR-X1-N-PC	● Negro	1xAR111	165*165*41	135*155	10u. / 40u.	

MATERIAL

PC



Artefactos compatibles con lámparas de Ø50 mm.

PLAFÓN LISO PC		FORMA	COMPATIBLE	DIMENSIONES	CORTE	INTER / MASTER	PRECIO SIN IVA
APCDL-X1-B-PC	● Blanco	Cuadrado	1xGU10	96*96*100	Ø50	10u. / 50u.	7,72 USD
APRDL-X1-B-PC	○ Blanco	Redondo	1xGU10	96*96*100	Ø50	10u. / 50u.	7,72 USD
APCDL-X1-N-PC	● Negro	Cuadrado	1xGU10	96*96*100	Ø50	10u. / 50u.	7,72 USD
APRDL-X1-N-PC	● Negro	Redondo	1xGU10	96*96*100	Ø50	10u. / 50u.	7,72 USD
APCDL-X2-B-PC	● Blanco	Cuadrado	2xGU10	186*98*100	Ø50	5u. / 20u.	16,38 USD
APRDL-X2-B-PC	○ Blanco	Redondo	2xGU10	186*98*100	Ø50	5u. / 20u.	16,38 USD
APCDL-X2-N-PC	● Negro	Cuadrado	2xGU10	186*98*100	Ø50	5u. / 20u.	16,38 USD
APRDL-X2-N-PC	● Negro	Redondo	2xGU10	186*98*100	Ø50	5u. / 20u.	16,38 USD
							IVA 21%

MATERIAL

PC



PLAFÓN RANURADO PC		FORMA	COMPATIBLE	DIMENSIONES	CORTE	INTER / MASTER	PRECIO SIN IVA
APCDR-X1-B-PC	● Blanco	Cuadrado	1xGU10	96*96*100	Ø50	10u. / 50u.	7,72 USD
APRDR-X1-B-PC	○ Blanco	Redondo	1xGU10	96*96*100	Ø50	10u. / 50u.	7,72 USD
APCDR-X1-N-PC	● Negro	Cuadrado	1xGU10	96*96*100	Ø50	10u. / 50u.	7,72 USD
APRDR-X1-N-PC	● Negro	Redondo	1xGU10	96*96*100	Ø50	10u. / 50u.	7,72 USD
APCDR-X2-B-PC	● Blanco	Cuadrado	2xGU10	186*98*100	Ø50	5u. / 20u.	16,38 USD
APRDR-X2-B-PC	Blanco	Redondo	2xGU10	186*98*100	Ø50	5u. / 20u.	16,38 USD
APCDR-X2-N-PC	● Negro	Cuadrado	2xGU10	186*98*100	Ø50	5u. / 20u.	16,38 USD
APRDR-X2-N-PC	● Negro	Redondo	2xGU10	186*98*100	Ø50	5u. / 20u.	16,38 USD
							IVA 21%

MATERIAL

LENTE: PC

CUERPO: ABS+ PC



Protección IP54



Iluminación Unidireccional



ARTEFACTO DE PARED UNIDIRECCIONAL	Color	Forma	SPOT	COMPATIBLE	DIMENSIONES	MASTER	PRECIO SIN IVA
AECN-X1	● Negro	Cuadrado	x1	GU10/MR16	162x90x113	16u.	23,71 USD
AECB-X1	○ Blanco	Cuadrado	x1	GU10/MR16	162x90x113	16u.	23,38 USD
AERN-X1	● Negro	Redondo	x1	GU10/MR16	162x90x113	16u.	22,95 USD
AERB-X1	○ Blanco	Redondo	x1	GU10/MR16	162x90x113	16u.	22,87 USD
							IVA 21%

MATERIAL

LENTE: PC

CUERPO: ABS+ PC



Protección IP54



Iluminación Bidireccional



ARTEFACTO DE PARED BIDIRECCIONAL	Color	Forma	SPOT	COMPATIBLE	DIMENSIONES	MASTER	PRECIO SIN IVA
AECN-X2	● Negro	Cuadrado	x2	GU10/MR16	215x90x113	16u.	29,75 USD
AECB-X2	○ Blanco	Cuadrado	x2	GU10/MR16	215x90x113	16u.	29,07 USD
AERN-X2	● Negro	Redondo	x2	GU10/MR16	215x90x113	16u.	29,10 USD
AERB-X2	○ Blanco	Redondo	x2	GU10/MR16	215x90x113	16u.	28,30 USD
							IVA 21%

MATERIAL

PC



Protección IP54



Iluminación Unidireccional

ARTEFACTO DE PARED LED INTEGRADO	Color	Temperatura	Flujo	DIMENSIONES	MASTER	PRECIO SIN IVA	
AECN-3W	● Negro	Cálido	2700°K	460lm	120x32x120	24u.	21,63 USD
AECB-3W	○ Blanco	Cálido	2700°K	460lm	120x32x120	24u.	22,44 USD
							IVA 21%

Multicolor RGB + Blancos



Control por Voz

Controla todos tus dispositivos mediante los asistentes de voz Alexa®, Siri® o Google Assistant®.



Programación ON/OFF

Programa tus dispositivos para que prendan o apaguen, cuándo y cómo vos quieras mediante nuestra App.



DIY de escenas

Programas combinaciones de dispositivos con distintas tonalidades y funciones.



Garantía y Asistencia

2 años de Garantía por defectos de fabricación y asistencia gratuita por redes sociales.



BULBO LED A60 12W SMART RGB+W / E27 / Ø60x122mm				VIDA ÚTIL	MASTER	VENTA MIN.	PRECIO SIN IVA
SBT-A60-12W-RGB	Cálido	Frío	RGB 400-700mm	20000hs	100u.	10u.	14,87 USD
							IVA 10,5%



DICROICA LED 5W Smart RGB+W / GU10 / Ø50x54mm				VIDA ÚTIL	MASTER	VENTA MIN.	PRECIO SIN IVA
SDL-MR16-5W-RGB	Cálido	Frío	RGB 400-700mm	20000hs	100u.	10u.	16,13 USD
							IVA 10,5%

Multicolor RGB + Blancos

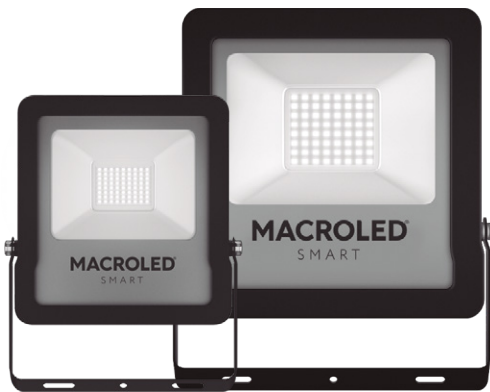

Control por Voz

Controla todos tus dispositivos mediante los asistentes de voz Alexa®, Siri® o Google Assistant®.



Programación ON/OFF

Programa tus dispositivos para que prendan o apaguen, cuándo y cómo vos quieras mediante nuestra App.



DIY de escenas

Programas combinaciones de dispositivos con distintas tonalidades y funciones.



Garantía y Asistencia

2 años de Garantía por defectos de fabricación y asistencia gratuita por redes sociales.



REFLECTOR 20W SMART RGB+W / IP65 / 209x168x30mm				VIDA ÚTIL	MASTER	VENTA MIN.	PRECIO SIN IVA
SMA-FLSV2-20RGBWW	Cálido	Frío	RGB 400-700mm	20000hs	20u.	5u.	63,87 USD
							IVA 21%



REFLECTOR 50W SMART RGB+W / IP65 / 237x200x36mm				VIDA ÚTIL	MASTER	VENTA MIN.	PRECIO SIN IVA
SMA-FLSV2-50RGBWW	Cálido	Frío	RGB 400-700mm	20000hs	12u.	3u.	106,34 USD
							IVA 21%



1 Punto



2 Puntos

Todos los puntos de las Teclas MILAN son apto combinación

1 a 2 Puntos / 120x80x39,5mm		CORRIENTE	TENSIÓN	MASTER	VENTA MIN.	PRECIO SIN IVA
MILAN-1CN-B	<input type="radio"/> 1 Punto	10A máx.	250V~	100u.	10u.	2,63 USD
MILAN-1CN-G	<input checked="" type="radio"/> 1 Punto	10A máx	250V~	100u.	10u.	3,26 USD
MILAN-1CN-N	<input type="radio"/> 1 Punto	10A máx	250V~	100u.	10u.	3,44 USD
MILAN-2CN-B	<input type="radio"/> 2 Puntos	10A máx	250V~	100u.	10u.	4,16 USD
MILAN-2CN-G	<input checked="" type="radio"/> 2 Puntos	10A máx	250V~	100u.	10u.	4,16 USD
MILAN-2CN-N	<input type="radio"/> 2 Puntos	10A máx	250V~	100u.	10u.	4,16 USD
						IVA 10.5%



3 Puntos



4 Puntos

Todos los puntos de las Teclas MILAN son apto combinación

3 a 4 Puntos / 120x80x39,5mm		CORRIENTE	TENSIÓN	MASTER	VENTA MIN.	PRECIO SIN IVA
MILAN-3CN-B	<input type="radio"/> 3 Puntos	10A máx.	250V~	100u.	10u.	4,40 USD
MILAN-3CN-G	<input checked="" type="radio"/> 3 Puntos	10A máx	250V~	100u.	10u.	5,11 USD
MILAN-3CN-N	<input type="radio"/> 3 Puntos	10A máx	250V~	100u.	10u.	5,46 USD
MILAN-4CN-B	<input type="radio"/> 4 Puntos	10A máx	250V~	100u.	10u.	6,16 USD
MILAN-4CN-G	<input checked="" type="radio"/> 4 Puntos	10A máx	250V~	100u.	10u.	6,16 USD
MILAN-4CN-N	<input type="radio"/> 4 Puntos	10A máx	250V~	100u.	10u.	6,16 USD
						IVA 10.5%



CUMPLE CON
NORMA IRAM



MATERIAL
IGNÍFUGO



RUBERRY SOFT
TOUCH



PROTECCIÓN
IP20



2 tomas



1 toma



1 toma vertical



1 toma 20A



1 toma Mignon



1 toma 20A Mignon

TOMACORRIENTES 120x80x39,5mm		CORRIENTE	TENSIÓN	MASTER	VENTA MIN.	PRECIO SIN IVA
MILAN-2TC-B	○ 2 tomacorrientes	10A máx.	250V~	100u.	10u.	2,87 USD
MILAN-2TC-G	● 2 tomacorrientes	10A máx.	250V~	100u.	10u.	3,36 USD
MILAN-2TC-N	● 2 tomacorrientes	10A máx.	250V~	100u.	10u.	3,36 USD
MILAN-1TC-B	○ 1 tomacorriente	10A máx.	250V~	100u.	10u.	2,31 USD
MILAN-1TC-G	● 1 tomacorriente	10A máx.	250V~	100u.	10u.	2,84 USD
MILAN-1TC-N	● 1 tomacorriente	10A máx.	250V~	100u.	10u.	2,84 USD
MILAN-1TC-V-B	○ 1 tomacorriente vertical	10A máx.	250V~	100u.	10u.	2,31 USD
MILAN-1TC-V-G	● 1 tomacorriente vertical	10A máx.	250V~	100u.	10u.	2,84 USD
MILAN-1TC-V-N	● 1 tomacorriente vertical	10A máx.	250V~	100u.	10u.	2,84 USD
MILAN-TC20A-B	○ 1 tomacorriente 20A	20A máx	250V~	100u.	10u.	3,089 USD
MILAN-TC20A-G	● 1 tomacorriente 20A	20A máx	250V~	100u.	10u.	3,61 USD
MILAN-TC20A-N	● 1 tomacorriente 20A	20A máx	250V~	100u.	10u.	3,61 USD
						IVA 10,5%

TOMACORRIENTES MIGNON 80x80x35mm		CORRIENTE	TENSIÓN	MASTER	VENTA MIN.	PRECIO SIN IVA
MILAN-1TC-MG-B	○ 1 tomacorriente Mignon	10A máx.	250V~	100u.	10u.	2,21 USD
MILAN-1TC-MG-G	● 1 tomacorriente Mignon	10A máx	250V~	100u.	10u.	2,75 USD
MILAN-1TC-MG-N	● 1 tomacorriente Mignon	10A máx	250V~	100u.	10u.	2,75 USD
MILAN-TC20A-MG-B	○ 1 tomacorriente 20A Mignon	20A máx	250V~	100u.	10u.	2,98 USD
MILAN-TC20A-MG-G	● 1 tomacorriente 20A Mignon	20A máx	250V~	100u.	10u.	3,51 USD
MILAN-TC20A-MG-N	● 1 tomacorriente 20A Mignon	20A máx	250V~	100u.	10u.	3,51 USD
						IVA 10,5%



1 Punto + 1 toma



2 Puntos + 1 toma



1 Punto + 2 USB-C

1 y 2 Puntos + Toma / 1 Punto + 2 USB-C / 120x80x39,5mm		CORRIENTE	TENSIÓN	MASTER	VENTA MIN.	PRECIO SIN IVA
MILAN-1CN-1TC-B	○ 1 Punto + 1 toma	10A máx.	250V~	60u.	6u.	3,61 USD
MILAN-1CN-1TC-G	● 1 Punto + 1 toma	10A máx	250V~	60u.	6u.	4,15 USD
MILAN-1CN-1TC-N	● 1 Punto + 1 toma	10A máx	250V~	60u.	6u.	4,15 USD
MILAN-2CN-1TC-B	○ 2 Puntos + 1 toma	10A máx	250V~	100u.	10u.	4,85 USD
MILAN-2CN-1TC-G	● 2 Puntos + 1 toma	10A máx	250V~	100u.	10u.	5,59 USD
MILAN-2CN-1TC-N	● 2 Puntos + 1 toma	10A máx	250V~	100u.	10u.	5,59 USD
MILAN-1CN-2USB-C-B	○ 1 Punto + 2 USB-C	10A máx	250V~	60u.	6u.	19,22 USD
MILAN-1CN-2USB-C-G	● 1 Punto + 2 USB-C	10A máx	250V~	60u.	6u.	19,90 USD
MILAN-1CN-2USB-C-N	● 1 Punto + 2 USB-C	10A máx	250V~	60u.	6u.	19,90 USD
						IVA 10.5%



2 Tomas + 2 USB-C



2 tomas + 1 USB-C

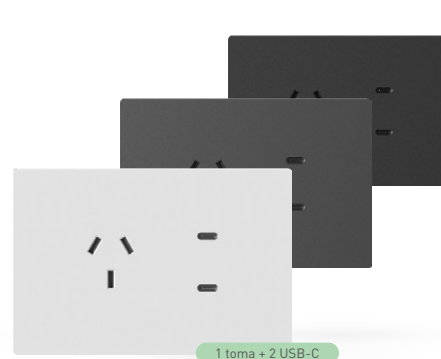

1 toma + 2 USB-C

1 y 2 Tomas + 1 a 2 USB-C / 120x80x39,5mm		CORRIENTE	TENSIÓN	MASTER	VENTA MIN.	PRECIO SIN IVA
MILAN-2CN-2USB-C-B	○ 2 tomas + 2 USB-C	10A máx.	250V~	60u.	6u.	19,64 USD
MILAN-2CN-2USB-C-G	● 2 tomas + 2 USB-C	10A máx.	250V~	60u.	6u.	20,37 USD
MILAN-2CN-2USB-C-N	● 2 tomas + 2 USB-C	10A máx.	250V~	60u.	6u.	20,37 USD
MILAN-2TC-1USB-C-B	○ 2 tomas + 1 USB-C	10A máx.	250V~	60u.	6u.	22,05 USD
MILAN-2TC-1USB-C-G	● 2 tomas + 1 USB-C	10A máx.	250V~	60u.	6u.	22,68 USD
MILAN-2TC-1USB-C-N	● 2 tomas + 1 USB-C	10A máx.	250V~	60u.	6u.	22,68 USD
MILAN-1TC-2USB-C-B	○ 1 toma + 2 USB-C	10A máx.	250V~	60u.	6u.	21,32 USD
MILAN-1TC-2USB-C-G	● 1 toma + 2 USB-C	10A máx.	250V~	60u.	6u.	22,10 USD
MILAN-1TC-2USB-C-N	● 1 toma + 2 USB-C	10A máx.	250V~	60u.	6u.	22,10 USD
						IVA 10.5%



1 Punto + 1 dimmer

Consumo 220W
por dimmer



1 dimmer

Consumo 220W
por dimmer



2 dimmer

Consumo 220W x2
por dimmer

1 Punto + 1 Dimmer / 180*80*58mm		CORRIENTE	TENSIÓN	MASTER	VENTA MIN.	PRECIO SIN IVA
MILAN-1CN-1D-B	○ 1 Punto + 1 Dimmer	10A máx. / Dimmer 1A máx.	100 - 250V~	60u.	6u.	23,26 USD
MILAN-1CN-1D-G	● 1 Punto + 1 Dimmer	10A máx. / Dimmer 1A máx.	100 - 250V~	60u.	6u.	23,33 USD
MILAN-1CN-1D-N	● 1 Punto + 1 Dimmer	10A máx. / Dimmer 1A máx.	100 - 250V~	60u.	6u.	23,33 USD
						IVA 21%

1 a 2 Dimmer / 180*80*51mm		CORRIENTE	TENSIÓN	MASTER	VENTA MIN.	PRECIO SIN IVA
MILAN-1D-B	○ 1 Dimmer	1A máx.	100 - 250V~	60u.	6u.	20,31 USD
MILAN-1D-G	● 1 Dimmer	1A máx.	100 - 250V~	60u.	6u.	21,32 USD
MILAN-1D-N	● 1 Dimmer	1A máx.	100 - 250V~	60u.	6u.	21,32 USD
MILAN-2D-B	○ 2 Dimmer	1A máx. por módulo	100 - 250V~	60u.	6u.	38,48 USD
MILAN-2D-G	● 2 Dimmer	1A máx. por módulo	100 - 250V~	60u.	6u.	39,50 USD
MILAN-2D-N	● 2 Dimmer	1A máx. por módulo	100 - 250V~	60u.	6u.	39,50 USD
						IVA 21%



1 ventilador



1 punto + 1 ventilador

Todos los puntos de las Teclas MILAN son apto combinación

VEN / 120x80x51mm - 1 Punto + VEN / 120x80x58mm		CORRIENTE	TENSIÓN	MASTER	VENTA MIN.	PRECIO SIN IVA
MILAN-1V-B	○ 1 Ventilador	1A máx	AC100-250V~	60u.	6u.	18,53 USD
MILAN-1V-G	● 1 Ventilador	1A máx	AC100-250V~	60u.	6u.	19,46 USD
MILAN-1V-N	● 1 Ventilador	1A máx	AC100-250V~	60u.	6u.	19,46 USD
MILAN-1CN-1V-B	○ 1 Punto + 1 Ventilador	10A máx. / VEN 1A máx.	AC100-250V~	60u.	6u.	22,11 USD
MILAN-1CN-1V-G	● 1 Punto + 1 Ventilador	10A máx. / VEN 1A máx.	AC100-250V~	60u.	6u.	23,26 USD
MILAN-1CN-1V-N	● 1 Punto + 1 Ventilador	10A máx. / VEN 1A máx.	AC100-250V~	60u.	6u.	23,26 USD
						IVA 21%

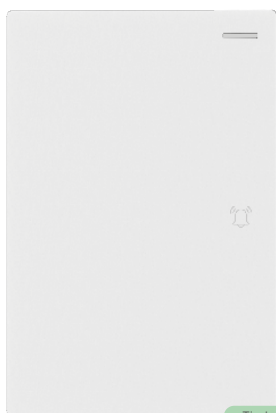

Timbre

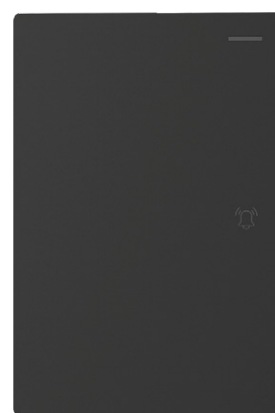
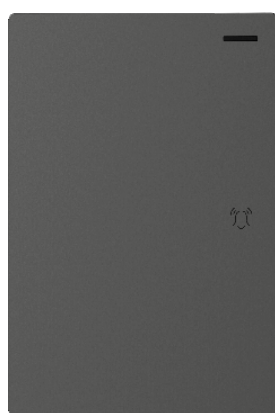

Timbre / 120x80x39,5mm		CORRIENTE	TENSIÓN	MASTER	VENTA MIN.	PRECIO SIN IVA
MILAN-T-B	○ 1 Pulsador	10A máx.	250V~	100u.	10u.	2,94 USD
MILAN-T-G	● 1 Pulsador	10A máx	250V~	100u.	10u.	3,80 USD
MILAN-T-N	● 1 Pulsador	10A máx	250V~	100u.	10u.	3,80 USD
						IVA 10.5%



Módulo pulsador

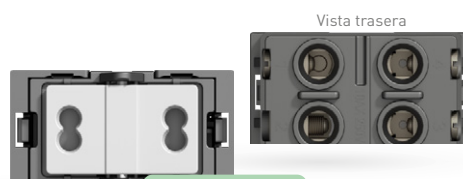

Módulo 1 punto - 3 vías

Pulsador - Módulo / 24x45x35,2 mm		CORRIENTE	TENSIÓN	MASTER	VENTA MIN.	PRECIO SIN IVA
MILAN-1CN-PUL	● Módulo pulsador	10A máx.	250V~	100u.	10u.	1,22 USD
						IVA 10.5%

Módulo 1 punto - 3 vías / 24x45x35,2 mm		CORRIENTE	TENSIÓN	MASTER	VENTA MIN.	PRECIO SIN IVA
MILAN-MOD-1CN3V	● Módulo 1 punto - 3 vías	10A máx.	250V~	100u.	10u.	2,73 USD
						IVA 10.5%



CUMPLE CON NORMA IRAM



MATERIAL IGNÍFUGO



RUBERRY SOFT TOUCH



PROTECCIÓN IP20



RJ11

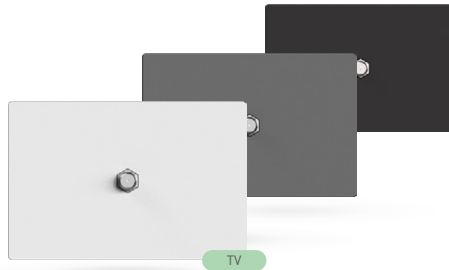

TV



RJ45

Ventana retráctil



RJ11 / 120x80x45mm - TV / 120x80x21mm - RJ45 / 120x80x35mm		TENSIÓN	MASTER	VENTA MIN.	
MILAN-RJ11-B	○ Red RJ11	-	100u.	10u.	3,23 USD
MILAN-RJ11-G	● Red RJ11	-	100u.	10u.	3,76 USD
MILAN-RJ11-N	● Red RJ11	-	100u.	10u.	3,76 USD
MILAN-TV-B	○ TV	-	100u.	10u.	3,23 USD
MILAN-TV-G	● TV	-	100u.	10u.	3,76 USD
MILAN-TV-N	● TV	-	100u.	10u.	11,80 USD
MILAN-RJ45-B	○ Red RJ45	-	100u.	10u.	3,96 USD
MILAN-RJ45-G	● Red RJ45	-	100u.	10u.	4,54 USD
MILAN-RJ45-N	● Red RJ45	-	100u.	10u.	4,54 USD
IVA 21%					



CUMPLE CON NORMA IRAM



MATERIAL IGNÍFUGO



RUBERRY SOFT TOUCH



PROTECCIÓN IP20



RJ45-HDMI



HDMI

Ventana retráctil

Requiere conector HDMI en L



RJ45-HDMI / 120x80x38 - HDMI / 120x80x38mm		TENSIÓN	MASTER	VENTA MIN.	
MILAN-RJ45-HDMI-B	○ HDMI estándar (tipo A) + Red RJ45	-	100u.	10u.	9,53 USD
MILAN-RJ45-HDMI-G	● HDMI estándar (tipo A) + Red RJ45	-	100u.	10u.	10,13 USD
MILAN-RJ45-HDMI-N	● HDMI estándar (tipo A) + Red RJ45	-	100u.	10u.	10,13 USD
MILAN-HDMI-B	○ 2 HDMI estándar (tipo A)	-	100u.	10u.	15,80 USD
MILAN-HDMI-G	● 2 HDMI estándar (tipo A)	-	100u.	10u.	16,38 USD
MILAN-HDMI-N	● 2 HDMI estándar (tipo A)	-	100u.	10u.	16,38 USD
IVA 21%					

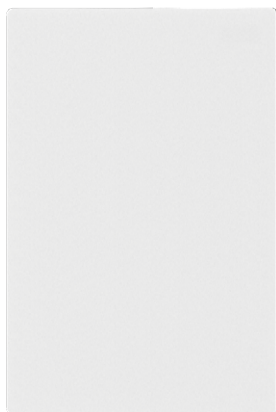

Tapa ciega

Tapa ciega / 120x80x39,5mm		CORRIENTE	TENSIÓN	MASTER	VENTA MIN.	PRECIO SIN IVA
MILAN-TCR-B	<input type="radio"/> Tapa ciega	-	-	200u.	20u.	1,83 USD
MILAN-TCR-G	<input checked="" type="radio"/> Tapa ciega	-	-	200u.	20u.	2,49 USD
MILAN-TCR-N	<input type="radio"/> Tapa ciega	-	-	200u.	20u.	
						IVA 10.5%

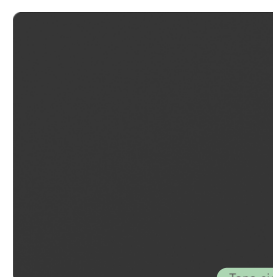
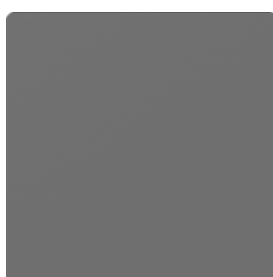
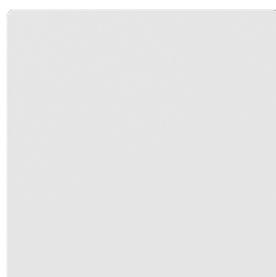

Tapa ciega Mignon

Tapa ciega Mignon / 80x80x10,5mm		CORRIENTE	TENSIÓN	MASTER	VENTA MIN.	PRECIO SIN IVA
MILAN-TCMG-B	<input type="radio"/> Tapa ciega cuadrada	-	-	200u.	20u.	1,60 USD
MILAN-TCMG-G	<input checked="" type="radio"/> Tapa ciega cuadrada	-	-	200u.	20u.	2,23 USD
MILAN-TCMG-N	<input type="radio"/> Tapa ciega cuadrada	-	-	200u.	20u.	
						IVA 10.5%

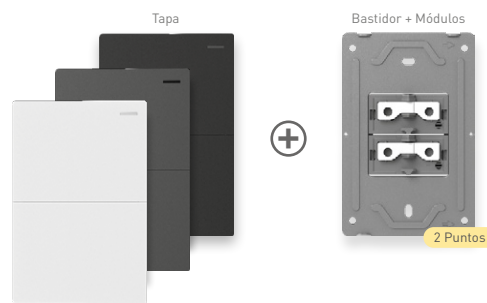
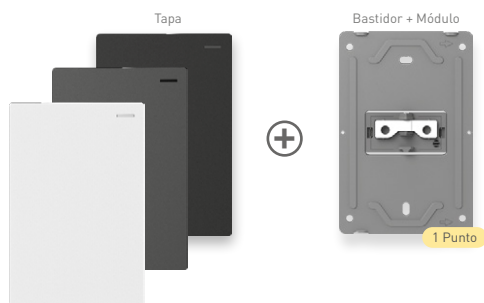

Tapa 1 Punto / 120x80x11,5mm		CORRIENTE	TENSIÓN	MASTER	VENTA MIN.	PRECIO SIN IVA
MILAN-TAPA-1CN-B	○ Tapa	-	-	100u.	10u.	0,88 USD
MILAN-TAPA-1CN-G	● Tapa	-	-	100u.	10u.	1,62 USD
MILAN-TAPA-1CN-N	● Tapa	-	-	100u.	10u.	
Bastidor + Módulo 1 Punto / 116.4x76.4x35.1mm						
MILAN-BAST-1CN	Bastidor + Módulo	10A máx.	250V~	100u.	10u.	1,90 USD
						IVA 21%

Tapa 2 Puntos / 120x80x11,5mm		CORRIENTE	TENSIÓN	MASTER	VENTA MIN.	PRECIO SIN IVA
MILAN-TAPA-2CN-B	○ Tapa	-	-	100u.	10u.	0,98 USD
MILAN-TAPA-2CN-G	● Tapa	-	-	100u.	10u.	1,72 USD
MILAN-TAPA-2CN-N	● Tapa	-	-	100u.	10u.	
Bastidor + Módulo 2 Puntos / 116.4x76.4x35.1mm						
MILAN-BAST-2CN	Bastidor + Módulos	10A máx.	250V~	100u.	10u.	2,78 USD
						IVA 21%

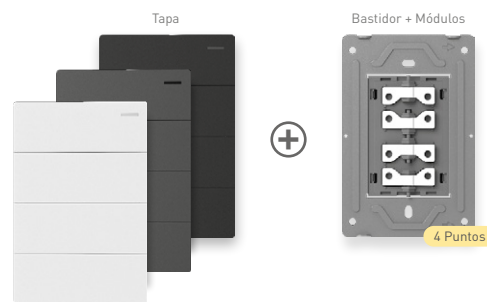
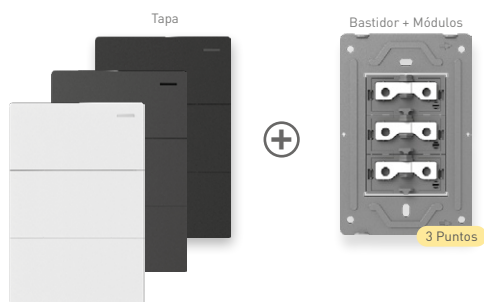

Tapa 3 Puntos / 120x80x11,5mm		CORRIENTE	TENSIÓN	MASTER	VENTA MIN.	PRECIO SIN IVA
MILAN-TAPA-3CN-B	○ Tapa	-	-	100u.	10u.	1,04 USD
MILAN-TAPA-3CN-G	● Tapa	-	-	100u.	10u.	1,80 USD
MILAN-TAPA-3CN-N	● Tapa	-	-	100u.	10u.	
Bastidor + Módulo 3 Puntos / 116.4x76.4x35.1mm						
MILAN-BAST-3CN	Bastidor + Módulos	10A máx.	250V~	100u.	10u.	3,74 USD
						IVA 21%

Tapa 4 Puntos / 120x80x11,5mm		CORRIENTE	TENSIÓN	MASTER	VENTA MIN.	PRECIO SIN IVA
MILAN-TAPA-4CN-B	○ Tapa	-	-	100u.	10u.	1,10 USD
MILAN-TAPA-4CN-G	● Tapa	-	-	100u.	10u.	1,86 USD
MILAN-TAPA-4CN-N	● Tapa	-	-	100u.	10u.	
Bastidor + Módulo 4 Puntos / 116.4x76.4x35.1mm						
MILAN-BAST-4CN	Bastidor + Módulos	10A máx.	250V~	100u.	10u.	4,80 USD
						IVA 21%



CUMPLE CON
NORMA IRAM



MATERIAL
IGNÍFUGO



RUBERRY SOFT
TOUCH



PROTECCIÓN
IP20

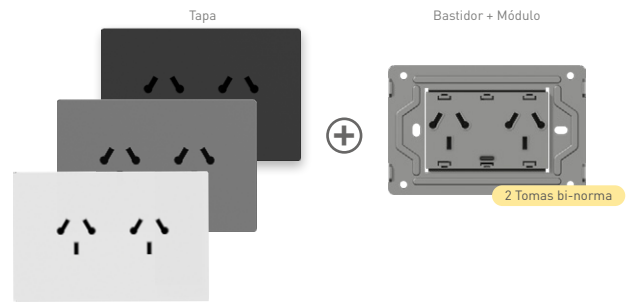
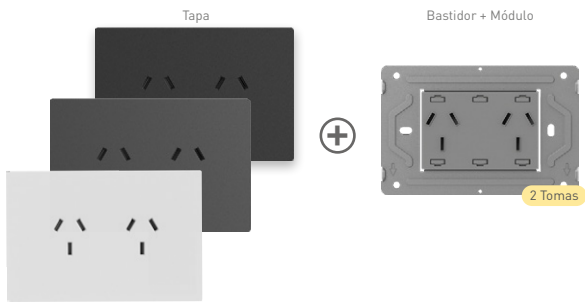

Tapa 2 Tomas / 120x80x7mm		CORRIENTE	TENSIÓN	MASTER	VENTA MIN.	PRECIO SIN IVA
MILAN-TAPA-2TC-B	○ Tapa	-	-	100u.	10u.	0,70 USD
MILAN-TAPA-2TC-G	● Tapa	-	-	100u.	10u.	1,20 USD
MILAN-TAPA-2TC-N	● Tapa	-	-	100u.	10u.	
Bastidor + Módulo 2 Tomas / 116.4x76.4x33mm						
MILAN-BAST-2TC	Bastidor + Módulo	10A máx.	250V~	100u.	10u.	2,28 USD
						IVA 21%

Tapa 2 Tomas bi-norma / 120x80x7mm		CORRIENTE	TENSIÓN	MASTER	VENTA MIN.	PRECIO SIN IVA
MILAN-TAPA-2TCBN-B	○ Tapa	-	-	100u.	10u.	0,68 USD
MILAN-TAPA-2TCBN-G	● Tapa	-	-	100u.	10u.	1,20 USD
MILAN-TAPA-2TCBN-N	● Tapa	-	-	100u.	10u.	
Bastidor + Módulo 2 Tomas bi-norma / 116.4x76.4x34,7mm						
MILAN-BAST-2TCBN	Bastidor + Módulos	10A máx.	250V~	100u.	10u.	2,38 USD
						IVA 21%

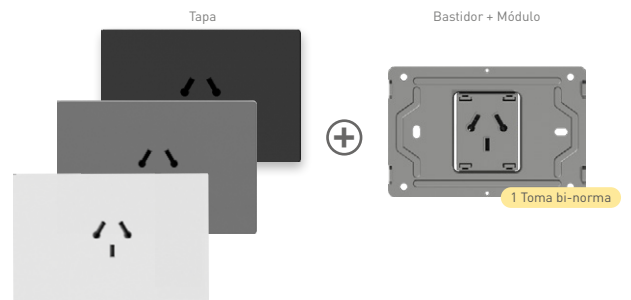
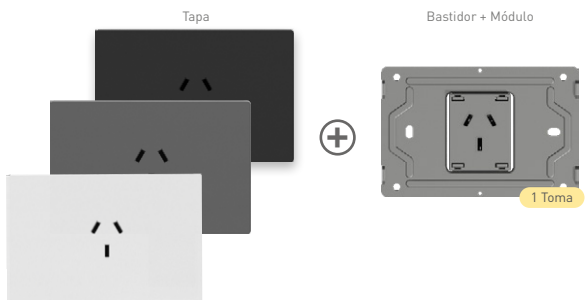

Tapa 1 Toma / 120x80x7mm		CORRIENTE	TENSIÓN	MASTER	VENTA MIN.	PRECIO SIN IVA
MILAN-TAPA-1TC-B	○ Tapa	-	-	100u.	10u.	1,68 USD
MILAN-TAPA-1TC-G	● Tapa	-	-	100u.	10u.	1,20 USD
MILAN-TAPA-1TC-N	● Tapa	-	-	100u.	10u.	
Bastidor + Módulo 1 Toma / 116.4x76.4x33mm						
MILAN-BAST-1TC	Bastidor + Módulos	10A máx.	250V~	100u.	10u.	1,64 USD
						IVA 21%

Tapa 1 Toma bi-norma / 120x80x7mm		CORRIENTE	TENSIÓN	MASTER	VENTA MIN.	PRECIO SIN IVA
MILAN-TAPA-1TCBN-B	○ Tapa	-	-	100u.	10u.	0,68 USD
MILAN-TAPA-1TCBN-G	● Tapa	-	-	100u.	10u.	1,20 USD
MILAN-TAPA-1TCBN-N	● Tapa	-	-	100u.	10u.	
Bastidor + Módulo 1 Toma bi-norma / 116.4x76.4x33,1mm						
MILAN-BAST-1TCBN	Bastidor + Módulo	10A máx.	250V~	100u.	10u.	2,00 USD
						IVA 21%



CUMPLE CON
NORMA IRAM



MATERIAL
IGNÍFUGO



RUBERRY SOFT
TOUCH



PROTECCIÓN
IP20

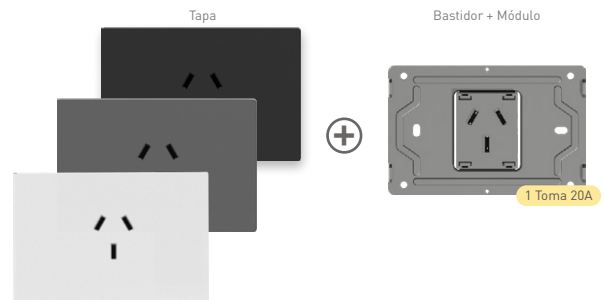
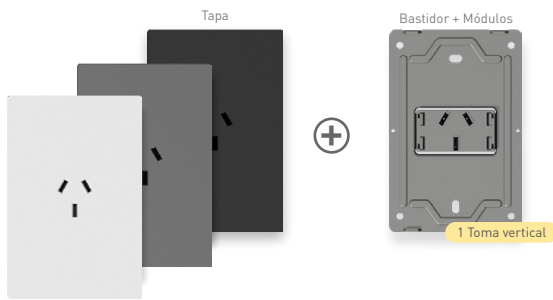

Tapa 1 Toma vertical / 120x80x7mm		CORRIENTE	TENSIÓN	MASTER	VENTA MIN.	PRECIO SIN IVA
MILAN-TAPA-1TC-V-B	○ Tapa	-	-	100u.	10u.	0,68 USD
MILAN-TAPA-1TC-V-G	● Tapa	-	-	100u.	10u.	1,20 USD
MILAN-TAPA-1TC-V-N	● Tapa	-	-	100u.	10u.	
Bastidor + Módulo 1 Toma vertical / 116.4x76.4x33mm						
MILAN-BAST-1TC-V	Bastidor + Módulos	10A máx.	250V~	100u.	10u.	1,64 USD IVA 21%

Tapa 1 Toma 20A / 120x80x7mm		CORRIENTE	TENSIÓN	MASTER	VENTA MIN.	PRECIO SIN IVA
MILAN-TAPA-TC20A-B	○ Tapa	-	-	100u.	10u.	0,68 USD
MILAN-TAPA-TC20A-G	● Tapa	-	-	100u.	10u.	1,20 USD
MILAN-TAPA-TC20A-N	● Tapa	-	-	100u.	10u.	
Bastidor + Módulo 1 Toma 20A / 116.4x76.4x33mm						
MILAN-BAST-TC20A	Bastidor + Módulos	20A máx.	250V~	100u.	10u.	2,44 USD IVA 21%

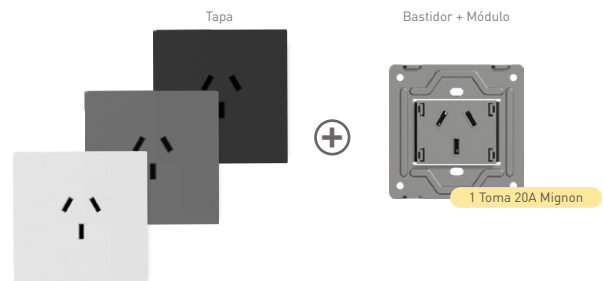
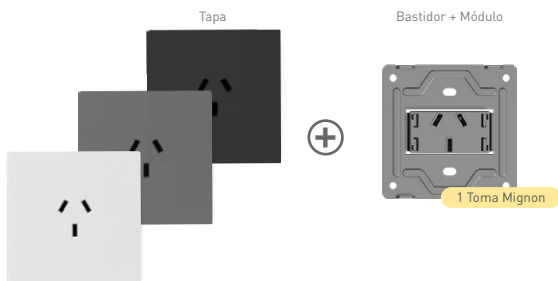

Tapa 1 Toma Mignon / 80x80x6,9mm		CORRIENTE	TENSIÓN	MASTER	VENTA MIN.	PRECIO SIN IVA
MILAN-TAPA-1TC-MG-B	○ Tapa	-	-	100u.	10u.	0,66 USD
MILAN-TAPA-1TC-MG-G	● Tapa	-	-	100u.	10u.	1,18 USD
MILAN-TAPA-1TC-MG-N	● Tapa	-	-	100u.	10u.	
Bastidor + Módulo 1 Toma Mignon / 76.4x76.4x33mm						
MILAN-BAST-1TC-MG	Bastidor + Módulo	10A máx.	250V~	100u.	10u.	1,60 USD IVA 21%

Tapa 1 Toma Mignon 20A / 80x80x6,9mm		CORRIENTE	TENSIÓN	MASTER	VENTA MIN.	PRECIO SIN IVA
MILAN-TAPA-TC20A-MG-B	○ Tapa	-	-	100u.	10u.	0,66 USD
MILAN-TAPA-TC20A-MG-G	● Tapa	-	-	100u.	10u.	1,18 USD
MILAN-TAPA-TC20A-MG-N	● Tapa	-	-	100u.	10u.	
Bastidor + Módulo 1 Toma Mignon 20A / 76.4x76.4x33mm						
MILAN-BAST-TC20A-MG	Bastidor + Módulos	20A máx.	250V~	100u.	10u.	2,40 USD IVA 21%

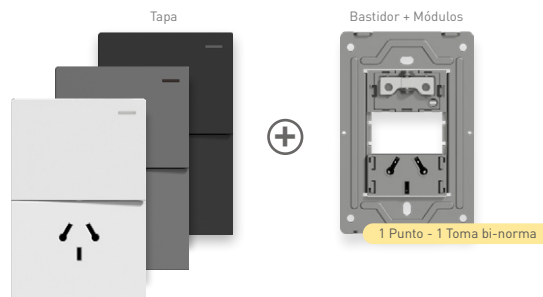
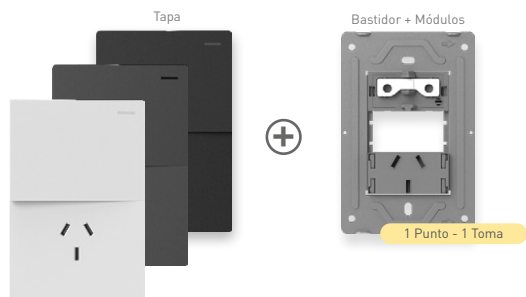

Tapa 1 Punto - 1 Toma / 120x80x11,5mm		CORRIENTE	TENSIÓN	MASTER	VENTA MIN.	PRECIO SIN IVA
MILAN-TAPA-1CN-1TC-B	○ Tapa	-	-	100u.	10u.	0,92 USD
MILAN-TAPA-1CN-1TC-G	● Tapa	-	-	100u.	10u.	1,42 USD
MILAN-TAPA-1CN-1TC-N	● Tapa	-	-	100u.	10u.	
Bastidor + Módulo 1 Punto - 1 Toma / 116.4x76.4x33,5mm						
MILAN-BAST-1CN-1TC	Bastidor + Módulos	10A máx.	250V~	100u.	10u.	2,86 USD IVA 21%

Tapa 1 Punto - 1 Toma bi-norma / 120x80x11,5mm		CORRIENTE	TENSIÓN	MASTER	VENTA MIN.	PRECIO SIN IVA
MILAN-TAPA-1CN-1TCBN-B	○ Tapa	-	-	100u.	10u.	0,92 USD
MILAN-TAPA-1CN-1TCBN-G	● Tapa	-	-	100u.	10u.	1,58 USD
MILAN-TAPA-1CN-1TCBN-N	● Tapa	-	-	100u.	10u.	
Bastidor + Módulo 1 Punto - 1 Toma bi-norma / 116.4x76.4x33,5mm						
MILAN-BAST-1CN-1TCBN	Bastidor + Módulos	20A máx.	250V~	100u.	10u.	2,90 USD IVA 21%

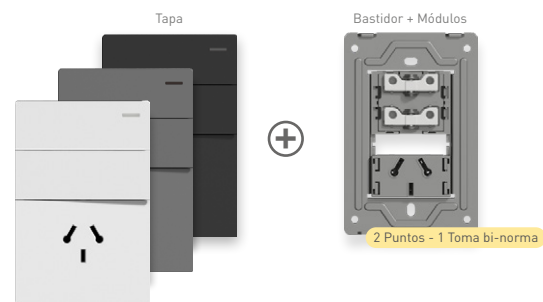
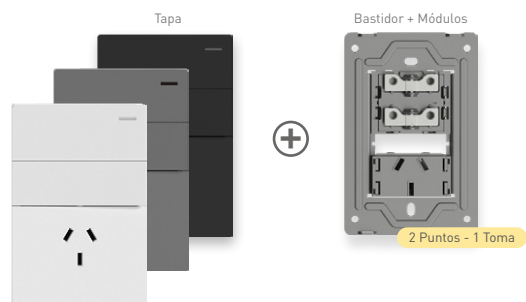

Tapa 2 Puntos - 1 Toma / 120x80x11,5mm		CORRIENTE	TENSIÓN	MASTER	VENTA MIN.	PRECIO SIN IVA
MILAN-TAPA-2CN-1TC-B	○ Tapa	-	-	100u.	10u.	0,96 USD
MILAN-TAPA-2CN-1TC-G	● Tapa	-	-	100u.	10u.	1,66 USD
MILAN-TAPA-2CN-1TC-N	● Tapa	-	-	100u.	10u.	
Bastidor + Módulo 2 Puntos - 1 Toma / 116.4x76.4x35,1mm						
MILAN-BAST-2CN-1TC	Bastidor + Módulos	10A máx.	250V~	100u.	10u.	3,80 USD IVA 21%

Tapa 2 Puntos - 1 Toma bi-norma / 120x80x11,5mm		CORRIENTE	TENSIÓN	MASTER	VENTA MIN.	PRECIO SIN IVA
MILAN-TAPA-2CN-1TCBN-B	○ Tapa	-	-	100u.	10u.	0,96 USD
MILAN-TAPA-2CN-1TCBN-G	● Tapa	-	-	100u.	10u.	1,66 USD
MILAN-TAPA-2CN-1TCBN-N	● Tapa	-	-	100u.	10u.	
Bastidor + Módulo 2 Puntos - 1 Toma bi-norma / 116.4x76.4x33,5mm						
MILAN-BAST-2CN-1TCBN	Bastidor + Módulos	10A máx.	250V~	100u.	10u.	3,88 USD IVA 21%

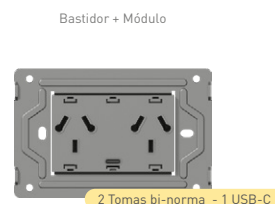
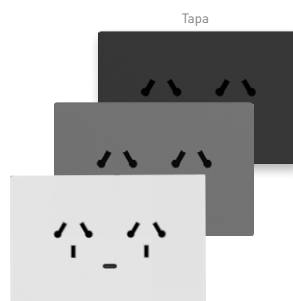
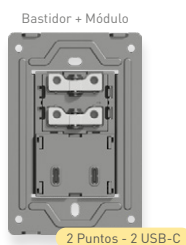

Tapa 2 Puntos - 2 USB-C / 120x80x11,5mm		CORRIENTE	TENSIÓN	MASTER	VENTA MIN.	PRECIO SIN IVA
MILAN-TAPA-2CN-2USB-C-B	○ Tapa	-	-	100u.	10u.	0,96 USD
MILAN-TAPA-2CN-2USB-C-G	● Tapa	-	-	100u.	10u.	1,66 USD
MILAN-TAPA-2CN-2USB-C-N	● Tapa	-	-	100u.	10u.	1,66 USD
Bastidor + Módulo 2 Puntos - 2 USB-C / 116.4x76.4x42,7mm						
MILAN-BAST-2CN-2USB-C	Bastidor + Módulo	10A máx.	250V~	60u.	6u.	17,98 USD
						IVA 21%

Tapa 2 Tomas bi-norma - 1 USB-C / 120x80x7mm		CORRIENTE	TENSIÓN	MASTER	VENTA MIN.	PRECIO SIN IVA
MILAN-TAPA-2TCBN-1USB-C-B	○ Tapa	-	-	100u.	10u.	0,68 USD
MILAN-TAPA-2TCBN-1USB-C-G	● Tapa	-	-	100u.	10u.	1,20 USD
MILAN-TAPA-2TCBN-1USB-C-N	● Tapa	-	-	100u.	10u.	1,20 USD
Bastidor + Módulo 2 Tomas bi-norma - 1 USB-C / 116.4x76.4x44,5mm						
MILAN-BAST-2TCBN-1USB-C	Bastidor + Módulos	10A máx.	250V~	60u.	6u.	18,08 USD
						IVA 21%

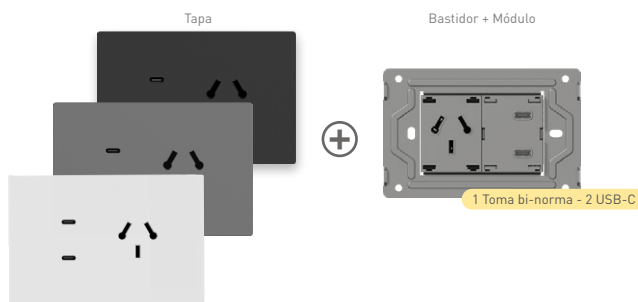

Tapa 1 Toma bi-norma - 2 USB-C / 120x80x7mm		CORRIENTE	TENSIÓN	MASTER	VENTA MIN.	PRECIO SIN IVA
MILAN-TAPA-1TCBN-2USB-C-B	○ Tapa	-	-	100u.	10u.	0,68 USD
MILAN-TAPA-1TCBN-2USB-C-G	● Tapa	-	-	100u.	10u.	1,20 USD
MILAN-TAPA-1TCBN-2USB-C-N	● Tapa	-	-	100u.	10u.	1,20 USD
Bastidor + Módulo 1 Toma bi-norma - 2 USB-C / 116.4x76.4x42,8mm						
MILAN-BAST-1TCBN-2USB-C	Bastidor + Módulos	10A máx.	250V~	60u.	6u.	17,40 USD
						IVA 21%

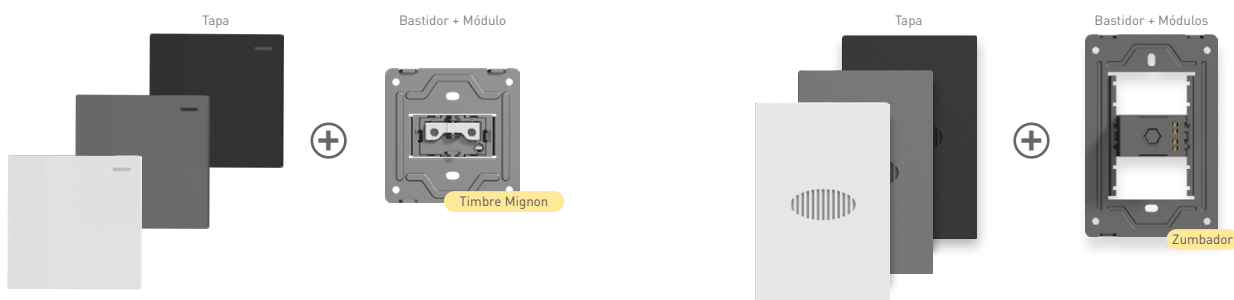

Tapa Timbre Mignon / 80x80x11,5mm		CORRIENTE	TENSIÓN	MASTER	VENTA MIN.	PRECIO SIN IVA
MILAN-TAPA-T-MG-B	○ Tapa	-	-	200u.	20u.	0,80 USD
MILAN-TAPA-T-MG-G	● Tapa	-	-	200u.	20u.	1,46 USD
MILAN-TAPA-T-MG-N	● Tapa	-	-	200u.	20u.	
Bastidor + Módulo Timbre Mignon / 76.4x76.4x35.1mm						
MILAN-BAST-T-MG	Bastidor + Módulo	10A máx.	250V~	100u.	10u.	1,84 USD
						IVA 10,5%

Tapa Zumbador / 120x80x7mm		CORRIENTE	TENSIÓN	MASTER	VENTA MIN.	PRECIO SIN IVA
MILAN-TAPA-ZUM-B	○ Tapa	-	-	100u.	10u.	0,70 USD
MILAN-TAPA-ZUM-G	● Tapa	-	-	100u.	10u.	1,20 USD
MILAN-TAPA-ZUM-N	● Tapa	-	-	100u.	10u.	
Bastidor + Módulo Zumbador / 116.4x76.4x40,8mm						
MILAN-BAST-ZUM	Bastidor + Módulos	10A máx.	250V~	60u.	6u.	5,60 USD
						IVA 21%



Tapa ciega Mignon / 80x80x6,9mm		CORRIENTE	TENSIÓN	MASTER	VENTA MIN.	PRECIO SIN IVA
MILAN-TAPA-TCMG-B	○ Tapa	-	-	200u.	20u.	0,76 USD
MILAN-TAPA-TCMG-G	● Tapa	-	-	200u.	20u.	1,34 USD
MILAN-TAPA-TCMG-N	● Tapa	-	-	200u.	20u.	
Bastidor + Módulo Tapa ciega Mignon / 76.4x76.4x6,5mm						
MILAN-BAST-TCMG	Bastidor	-	-	200u.	20u.	0,82 USD
						IVA 21%

Tapa ciega / 120x80x11,5mm		CORRIENTE	TENSIÓN	MASTER	VENTA MIN.	PRECIO SIN IVA
MILAN-TAPA-TCR-B	○ Tapa	-	-	100u.	10u.	0,80 USD
MILAN-TAPA-TCR-G	● Tapa	-	-	100u.	10u.	1,38 USD
MILAN-TAPA-TCR-N	● Tapa	-	-	100u.	10u.	
Bastidor + Módulo Tapa ciega / 116.4x76.4x35.1mm						
MILAN-BAST	Bastidor	-	-	100u.	10u.	0,80 USD
						IVA 21%

NUEVO SKU, MISMO PRODUCTO

MATERIAL PC+VIDRIO



Bluetooth



Wi-Fi



TECLAS VIDRIO SMART TOUCH / 120x80x36mm		CORRIENTE	TENSIÓN	MASTER	VENTA MIN.	PRECIO SIN IVA
◆ ROMA-S-1CH-N	● Negro x1 Canal	7A máx.	AC100-240V	40u.	1u.	22,11 USD
◆ ROMA-S-1CH-B	● Blanco x1 Canales	7A máx.	AC100-240V	40u.	1u.	
◆ ROMA-S-2CH-N	● Negro x2 Canales	7A máx.	AC100-240V	40u.	1u.	24,49 USD
◆ ROMA-S-2CH-B	● Blanco x2 Canales	7A máx.	AC100-240V	40u.	1u.	
◆ ROMA-S-3CH-B	● Blanco x3 Canales	7A máx.	AC100-240V	40u.	1u.	26,87 USD
◆ ROMA-S-3CH-N	● Negro x3 Canales	7A máx.	AC100-240V	40u.	1u.	
◆ TSX4B-CP	● Blanco x4 Canales	7A máx.	AC100-240V	40u.	1u.	29,26 USD
◆ ROMA-S-4CH-N	● Negro x4 Canales	7A máx.	AC100-240V	40u.	1u.	38,89 USD
◆ ROMA-S-4CH-B	● Blanco x4 Canales	7A máx.	AC100-240V	40u.	1u.	
						IVA 21%

MATERIAL PC+VIDRIO



Bluetooth



Wi-Fi



TECLA VIDRIO SMART DIMERIZABLE / 120x80x36mm		CORRIENTE	TENSIÓN	MASTER	VENTA MIN	PRECIO SIN IVA
DIM-TSX1B	● Blanco	3A máx.	AC100-240V	40u.	1u.	37,83 USD
DIM-TSX1N	● Negro	3A máx.	AC100-240V	40u.	1u.	
						IVA 21%

NUEVO SKU, MISMO PRODUCTO

MATERIAL PC+VIDRIO

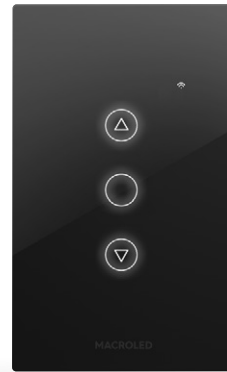
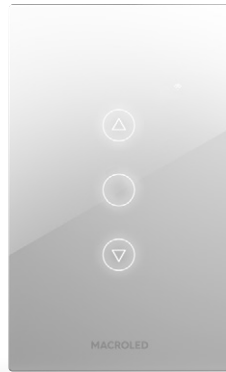

ROMA-S-PER-B

ROMA-S-PER-N



TECLA VIDRIO SMART PERSIANA / 120x80x36mm		CORRIENTE	TENSIÓN	MASTER	VENTA MIN.	PRECIO SIN IVA
◆ ROMA-S-PER-B	● Blanco	2A máx.	AC100-240V	40u.	1u.	42,78 USD
◆ ROMA-S-PER-N	● Negro	2A máx.	AC100-240V	40u.	1u.	
						IVA 21%

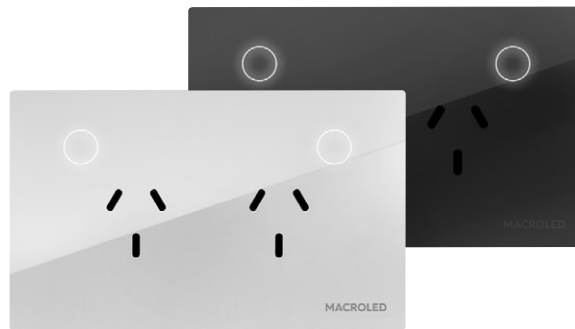

ANTIDSLUMBRANTE MOVIL PC	COLOR	CORRIENTE	TENSIÓN	MASTER	PRECIO SIN IVA
ROMA-S-2TC-B	● Blanco	10A máx.	AC100-240V	40u.	Consultar
ROMA-S-2TC-N	● Negro	10A máx.	AC100-240V	40u.	
					IVA 21%

MATERIAL

PC



TS-P1B-CP/TS-P1N-CP



TS-P2B-CP/TS-P2N-CP



TS-P3B-CP/TS-P3N-CP



TS-P4B-CP/TS-P4N-CP



TECLAS PULSADOR SMART / 120x80x43mm	CORRIENTE	TENSIÓN	MASTER	VENTA MIN.	PRECIO SIN IVA
TS-P1B-CP	● Blanco x1 Canal	7A máx.	AC100-240V	40u.	1u.
TS-P1N-CP	● Negro x1 Canal	7A máx.	AC100-240V	40u.	1u.
TS-P2B-CP	● Blanco x2 Canales	7A máx.	AC100-240V	40u.	1u.
TS-P2N-CP	● Negro x2 Canales	7A máx.	AC100-240V	40u.	1u.
TS-P3B-CP	● Blanco x3 Canales	7A máx.	AC100-240V	40u.	1u.
TS-P3N-CP	● Negro x3 Canales	7A máx.	AC100-240V	40u.	1u.
TS-P4B-CP	● Blanco x4 Canales	7A máx.	AC100-240V	40u.	1u.
TS-P4N-CP	● Negro x4 Canales	7A máx.	AC100-240V	40u.	1u.
					IVA 21%

MATERIAL

PC



TK-P1B-RF

TK-P2B-RF

TK-P3B-RF



Radio Frecuencia



Alcance Máx.
100m Espacio Abierto/
30m Espacio Cerrado



Encendido Apto para Combinación



NO REQUIERE FUENTE DE ALIMENTACIÓN

TECLA PULSADOR / 86x86x16.5mm	ALIMENTACIÓN	TRANSMISIÓN	MASTER	VENTA MIN.	PRECIO SIN IVA	
TK-P1B-RF	● Blanco x1 Canal RF	Autoalimentación por Energía Cinética	Radio Frec.	175u.	1u.	21,23 USD
TK-P2B-RF	○ Blanco x2 Canales RF	Autoalimentación por Energía Cinética	Radio Frec.	175u.	1u.	24,51 USD
TK-P3B-RF	● Blanco x3 Canales RF	Autoalimentación por Energía Cinética	Radio Frec.	175u.	1u.	25,70 USD
					IVA 21%	

MATERIAL

ABS+PC



Radio Frecuencia



Bluetooth



Wi-Fi



Radio Frecuencia

CON-K-RF

CON-K-RFWIFI



CONTROLADORAS	CORRIENTE	TENSIÓN	MASTER	VENTA MIN.	PRECIO SIN IVA	
CON-K-RF	Radio Frecuencia	10A máx.	AC100-240V	278u.	1u.	16,16 USD
CON-K-RFWIFI	Radio Frecuencia y Smart	16A máx.	AC100-240V	278u.	1u.	27,79 USD
					IVA 21%	

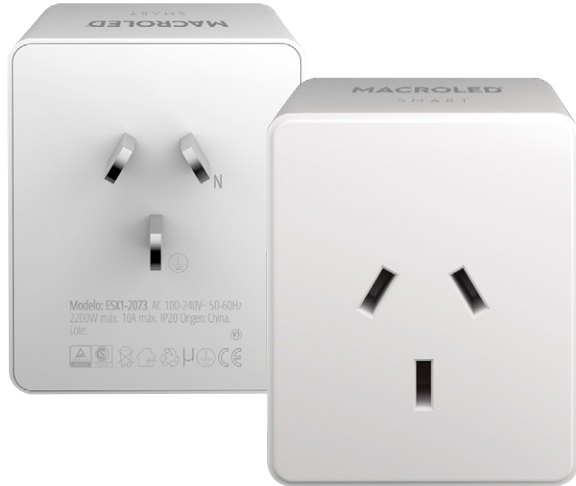

Control por Voz

Controla todos tus dispositivos mediante los asistentes de voz Alexa®, Siri® o Google Assistant®.



DIY de escenas

Programas combinaciones de dispositivos con distintas tonalidades y funciones.



Programación ON/OFF

Programa tus dispositivos para que prendan o apaguen, cuándo y cómo vos quieras mediante nuestra App.



Garantía y Asistencia

2 años de Garantía por defectos de fabricación y asistencia gratuita por redes sociales.



ENCHUFE SMART / 118x72x39mm	CORRIENTE	SPD	TENSIÓN	MASTER	VENTA MIN.	PRECIO SIN IVA
ESX1-2073	2200W máx.	10A máx.	AC2000V	100u.	1u.	20,67 USD
						IVA 10,5%

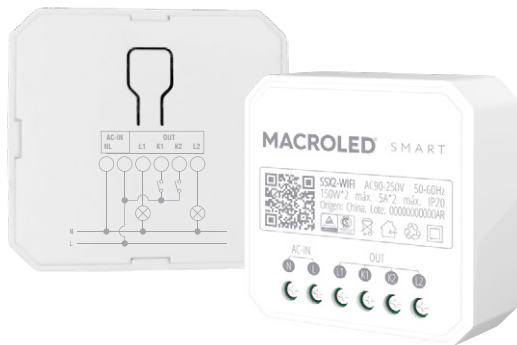

Control por Voz

Controla todos tus dispositivos mediante los asistentes de voz Alexa®, Siri® o Google Assistant®.



DIY de escenas

Programas combinaciones de dispositivos con distintas tonalidades y funciones.



Programación ON/OFF

Programa tus dispositivos para que prendan o apaguen, cuándo y cómo vos quieras mediante nuestra App.



Garantía y Asistencia

2 años de Garantía por defectos de fabricación y asistencia gratuita por redes sociales.



INTERRUPTOR SMART / 45x44x17mm	CORRIENTE	CABLEADO	TENSIÓN	MASTER	VENTA MIN.	PRECIO SIN IVA
SSX2-WIFI	150W*2	5A*2	0.75-1.0mm2	200u.	1u.	18,09 USD
						IVA 10,5%



SMSTB-360-5M-BL



SMSTB-360-5M-3AAA



SMSPB-110-8M-3AAA



SENSORES DE MOVIMIENTO	BATERÍA	ÁNGULO	DISTANCIA MÁX	INTER. /MASTER	VENTA MIN.	PRECIO SIN IVA
SMSTB-360-5M-BL	Litio Recargable USB	360°	5m	10u. / 200u.	10u.	39,69 USD
SMSTB-360-5M-3AAA	Alkalina 3x AAA	360°	5m	10u. / 200u.	10u.	34,18 USD
SMSPB-110-8M-3AAA	Alkalina 3x AAA	110° hor./ver.	8m	10u. / 200u.	10u.	31,91 USD
						IVA 21%



x2 Baterías Alkalinas AAA (incluidas)



SSH-30M2-2AAA



SENSOR DE HUMO	BATERÍA	INTER. /MASTER	VENTA MIN.	PRECIO SIN IVA
SSH-30M2-2AAA	Batería Alkalina 2x AAA	Niveles de sonido 85dB / 3ML	10u. / 50u.	10u.
				60,94 USD
				IVA 21%



SSPV-2AAA



x2 Baterías Alkalinas (incluidas)



SSPV-BL



Interfaz Micro USB 25V

Base desmontable Acceso ON/OFF - Reset



SENSORES DE PUERTAS Y VENTANAS	CONEXIÓN	MATERIAL	INTER. /MASTER	VENTA MIN.	PRECIO SIN IVA
SSPV-2AAA	Alkalina 2x AAA	Inalámbrica 2.4 GHz	10u. / 20u.	10u.	22,70 USD
SSPV-BL	Litio 3.7V/500mAh Recargable	Inalámbrica 2.4 GHz	10u. / 20u.	10u.	35,67 USD
					IVA 21%



Conexión USB 5V 1A



CSIR



CONTROL INFRA ROJO UNIVERSAL	ALIMENTACIÓN	MATERIAL	INTER. /MASTER	VENTA MIN.	PRECIO SIN IVA
CSIR	DC5V/1A / Línea USB-Typec (no incluye fuente)	PC+ABS	10u. / 100u	1u.	21,80 USD
					IVA 21%



FC01-6A-15LUX



FC02-10A-80LUX



FC03-25A-80LUX



FC04-10A-35LUX



FC-05-10A-35LUX

FOTOCÉLULAS	TENSIÓN	CORRIENTE	DETECCIÓN LUZ	MASTER	VENTA MIN.	PRECIO SIN IVA
FC-01-6A-15LUX	AC220-240V	6A	<5-15LUX	100u.	20u.	6,18 USD
FC-02-10A-80LUX	AC220-240V	10A	<5-80LUX	100u.	10u.	8,26 USD
FC-03-25A-80LUX	AC220-240V	25A	<5-80LUX	100u.	10u.	11,80 USD
FC-04-10A-35LUX	AC220-240V	10A	<5-35LUX	50u.	10u.	14,94 USD
FC05-10A-35LUX	AC85-305V	10A	<5-35LUX	50u.	10u.	7,40 USD
						IVA 21%



SMEB-360-6M-IP20



SMEB-360-12M-IP20

SENSORES DE EMBUTIR Y ROSCA	TENSIÓN	ÁNGULO	DISTANCIA MÁX	MASTER	VENTA MIN.	PRECIO SIN IVA
SMEB-360-6M-IP20	AC220-240V	360°	6m	50u.	10u.	18,13 USD
SMEB-360-12M-IP20	AC220-240V	360°	12m	50u.	10u.	23,09 USD
						IVA 21%



SMTB-360-6M-IP20

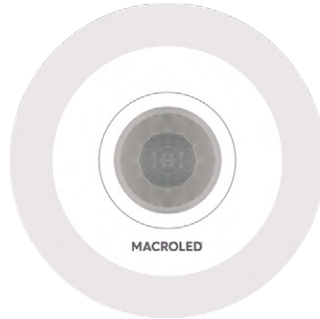

SMTB-360-8M-IP20



SMTB-360-20M-IP20

MOVIMIENTO DE PARED/TECHO	TENSIÓN	ÁNGULO	DISTANCIA MÁX	UV	MASTER	VENTA MIN.	PRECIO SIN IVA
SMTB-360-6M-IP20	AC220-240V	360°	6m	Si	50u.	10u.	17,66 USD
SMTB-360-8M-IP20	AC220-240V	360°	8m	Si	50u.	10u.	19,50 USD
SMTB-360-20M-IP20	AC220-240V	360°	20m	Si	50u.	10u.	30,20 USD
							IVA 21%



SMPB-180-12M-IP44
SMPN-180-12M-IP44

PARED



SMPB-180-12M-IP65
SMPN-180-12M-IP65

PARED Y TECHO



MOVIMIENTO DE PARED/TECHO	TENSIÓN	ÁNGULO	DISTANCIA MÁX.	UV	MASTER	VENTA MIN.	PRECIO SIN IVA
SMPB-180-12M-IP44	AC220-240V	180°	12m	Si	50u.	10u.	17,52 USD
SMPN-180-12M-IP44	AC220-240V	180°	12m	Si	50u.	10u.	17,52 USD
SMPB-180-12M-IP65	AC220-240V	180°	12m	Si	50u.	10u.	21,88 USD
SMPN-180-12M-IP65	AC220-240V	180°	12m	Si	50u.	10u.	21,88 USD



Brazo flexible



Protección IP20

- Potencia 20W
- Casquillo E27
- Brazo flexible



Febo

- Potencia 10W
- Función Dimerizable
- Panel Táctil

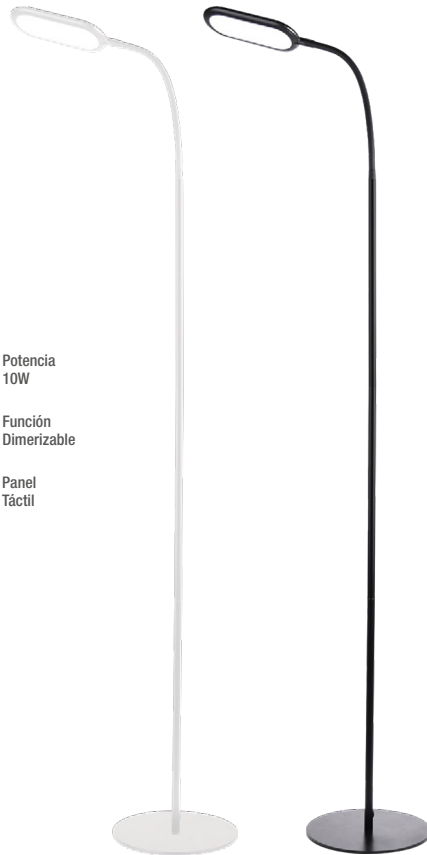

Júpiter

- Potencia 11W
- Función Dimerizable
- Panel Táctil

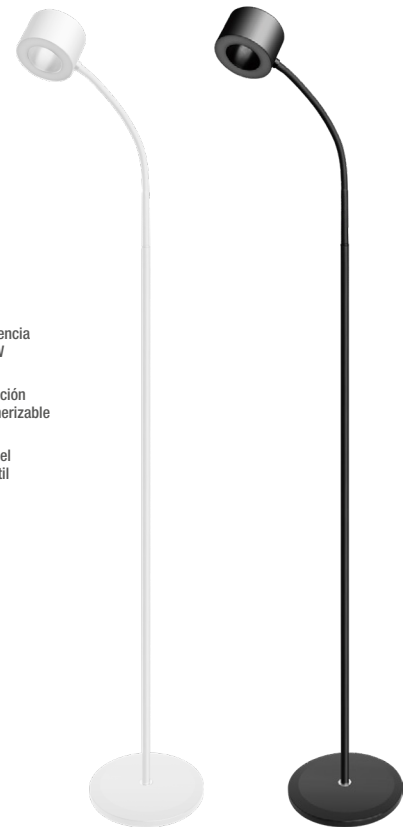

Marte



DE PIE	DIMERIZABLE	TIPO DE LUZ			POTENCIA	MASTER	VENTA MIN.	PRECIO SIN IVA
FEBO	No	Con portalámparas E27			20W máx	5u.	1u.	49,69 USD
JÚPITER NEGRO	Si	2700K	4500K	6000K	10W	3u.	1u.	48,00 USD
JÚPITER BLANCO	Si	2700K	4500K	6000K	10W	3u.	1u.	
MARTE NEGRO	Si	2700K	4500K	6000K	11W	4u.	1u.	48,05 USD
MARTE BLANCO	Si	2700K	4500K	6000K	11W	4u.	1u.	

IVA 21%

 Carga rápida inalámbrica 10W

 Protección IP20

 Función Dimerizable

 GARANTÍA
2
AÑOS



Mercurio



Baco



Vulcano

 Potencia 5W

 Panel Táctil

 Brazo móvil 180°

 Panel Táctil

 Con Parlante

 Brazo móvil 180°

 Panel Táctil

 Reloj con alarma

 Puerto USB

DE MESA	DIMERIZABLE	TIPO DE LUZ		CARGA	POTENCIA	MASTER	VENTA MIN.	PRECIO SIN IVA
MERCURIO	Si	Cálida	2700K	Inalámbrica 10W	5W	24u.	1u.	70,43 USD
BACO	Si	Cálida	2700K	Inalámbrica 10W	5W	20u.	1u.	101,00 USD
VULCANO	Si	Cálida	2700K	Inalámbrica 10W	5W	20u.	1u.	84,51 USD
IVA 21%								

 Memoria de última escena

 Protección IP20

 Función Dimerizable



Plutón



Saturno



Venus

 Carga rápida inalámbrica 10W

 Panel Táctil

 Puerto USB

 Carga rápida inalámbrica 10W

 Panel Táctil

 Brazo flexible

 Carga rápida inalámbrica 10W

 Panel Táctil

 Brazo flexible

VELADORES		TIPO DE LUZ			CARGA	POTENCIA	MASTER	VENTA MIN.	PRECIO SIN IVA
PLUTÓN NEGRO	Si	2700K	4500K	6500K	Inalámbrica 5W	5W	6u.	1u.	51,81 USD
PLUTÓN BLANCO	Si	2700K	4500K	6500K	Inalámbrica 5W	5W	6u.	1u.	41,91 USD
SATURNO NEGRO	Si	2700K			Inalámbrica 5W	4W	6u.	1u.	48,50 USD
SATURNO BLANCO	Si	2700K			Inalámbrica 5W	4W	6u.	1u.	48,50 USD
VENUS NEGRO	Si	2700K			Inalámbrica 5W	8W	10u.	1u.	43,58 USD
VENUS BLANCO	Si	2700K			Inalámbrica 5W	8W	10u.	1u.	43,58 USD
IVA 21%									



Brazo flexible



Memoria de última escena



Función Dimerizable



Cupido



Diana



Juno



Sensor de movimiento



Panel Táctil



Protección IP20



Panel Táctil



Puerto USB



Luz nocturna



Carga rápida inalámbrica 10W



Panel Táctil



Protección IP20



Ceres



Neptuno



Vesta



Carga rápida inalámbrica 10W



Panel Táctil



Puerto USB



Panel Táctil



Puerto USB



Protección IP20



Potencia 5W



Panel Táctil



Protección IP20

VELADORES	DIMERIZABLE	TIPO DE LUZ			CARGA	POTENCIA	MASTER	VENTA MIN.	PRECIO SIN IVA
CUPIDO NEGRO	Si	2700K			-	18W	4u.	1u.	81,09 USD
CUPIDO BLANCO	Si	2700K			-	18W	4u.	1u.	80,94 USD
DIANA NEGRO	Si	2700K	4500K	6500K	USB	7W	8u.	1u.	40,28 USD
DIANA BLANCO	Si	2700K	4500K	6500K	USB	7W	8u.	1u.	
JUNO NEGRO	Si	2700K			Inalámbrica 5W	6W	6u.	1u.	56,28 USD
JUNO BLANCO	Si	2700K			Inalámbrica 5W	6W	6u.	1u.	45,52 USD
CERES	Si	2700K	4500K	6500K	Inalambrica 10W	10W	12u.	1u.	54,00 USD
MINERVA	Si	2700K			-	4W	6u.	1u.	45,83 USD
NEPTUNO	Si	2700K	4500K	6500K	USB	7W	6u.	1u.	45,00 USD
VESTA	Si	2700K	4500K	6500K	-	6W	6u.	1u.	49,00 USD
									IVA 21%

 Encendido táctil y dimerizable

 Blanco cálido 2700K

 Memoria de última función

 GARANTÍA 1 AÑO



BELL

Carga USB-C

 Potencia 2W

 Batería de Litio Autonomía 6hs*

 Protección IP44

 Materialidad Hierro - PC - Plástico



ELEGANCE

Carga USB-C

 Potencia 2W

 Batería de Litio Autonomía 8hs*

 Protección IP20

 Materialidad Metal y PC

*La autonomía es al 100% de la potencia dimerizada.

VELADORES A BATERÍA	TIPO DE LUZ		TENSIÓN	CORRIENTE	VIDA ÚTIL	TIEMPO DE CARGA	MASTER	VENTA MIN.	PRECIO SIN IVA
BELL-N	Cálida	2700K	5V	1A	25.000hs	4hs	12u.	1u.	34,40 USD
ELEGANCE-C	Cálida	2700K	5V	1A	25.000hs	4hs	12u.	1u.	44,20 USD
									IVA 21%

 Encendido táctil y dimerizable

 Blanco cálido 2700K





 Memoria de última función

 GARANTÍA 1 AÑO



MUSHROOM

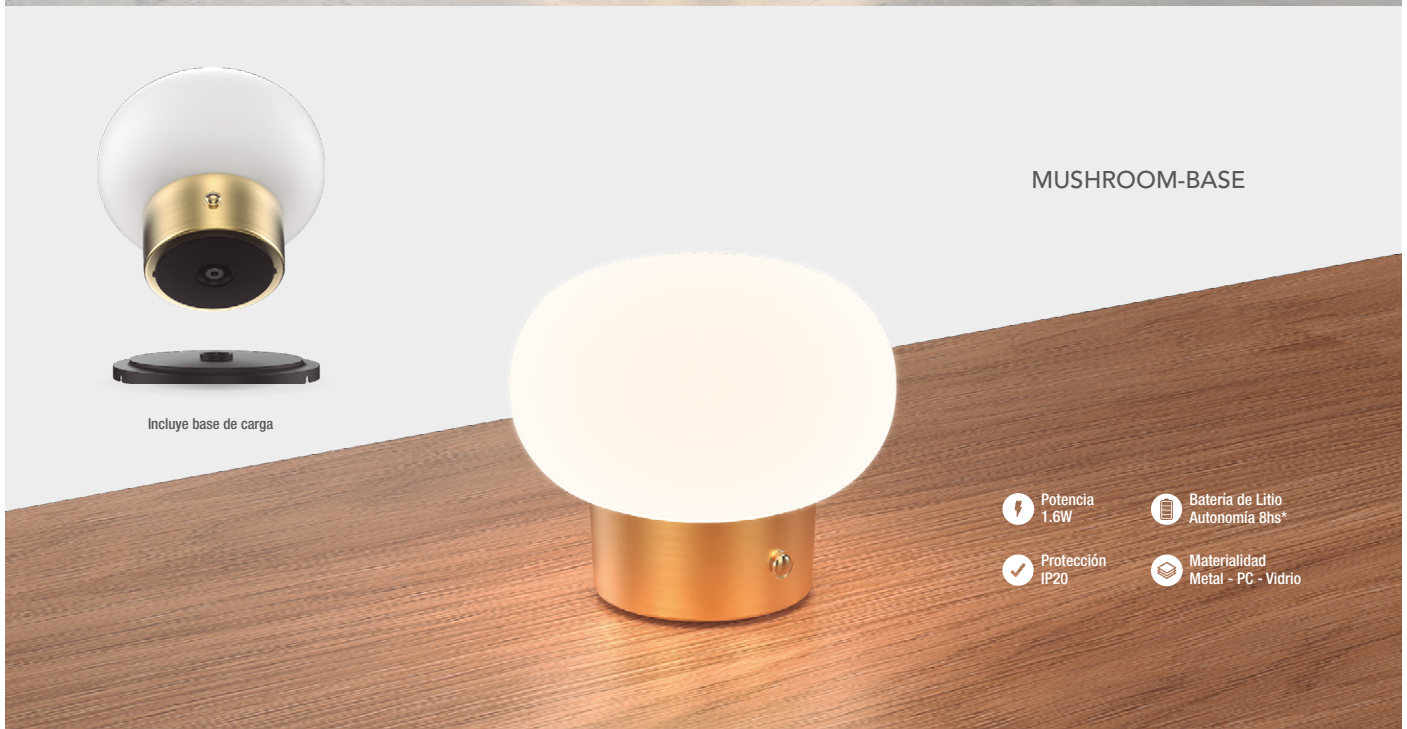

Carga USB-C

-  Potencia 1.6W
-  Batería de Litio Autonomía 8hs*
-  Protección IP20
-  Materialidad Metal - PC - Vidrio



MUSHROOM-BASE

Incluye base de carga

-  Potencia 1.6W
-  Batería de Litio Autonomía 8hs*
-  Protección IP20
-  Materialidad Metal - PC - Vidrio

*La autonomía es al 100% de la potencia dimerizada.

VELADORES A BATERÍA	TIPO DE LUZ		TENSIÓN	CORRIENTE	VIDA ÚTIL	TIEMPO DE CARGA	MASTER	VENTA MIN.	PRECIO SIN IVA
MUSHROOM-C-BASE	Cálida	2700K	5V	1A	25.000hs	4hs	12u.	1u.	51,20 USD IVA 21%



Encendido táctil y dimerizable



Blanco cálido 2700K



Memoria de última función



TOWER



Carga USB-C



Potencia 1.6W



Batería de Litio Autonomía 8hs*



Protección IP44



Materialidad ABS y PC



UMBRELLA



Carga USB-C



Potencia 1.6W



Batería de Litio Autonomía 8hs*



Protección IP44



Materialidad Hierro y PC

*La autonomía es al 100% de la potencia dimerizada.

VELADORES A BATERÍA	TIPO DE LUZ		TENSIÓN	CORRIENTE	VIDA ÚTIL	TIEMPO DE CARGA	MASTER	VENTA MIN.	PRECIO SIN IVA
TOWER-N	Cálida	2700K	5V	1A	25.000hs	4hs	12u.	1u.	41,03 USD
UMBRELLA-N	Cálida	2700K	5V	1A	25.000hs	4hs	12u.	1u.	43,45 USD
									IVA 21%



Encendido táctil y dimerizable



Blanco cálido 2700K



Memoria de última función



CANDLE-B

- Potencia 0.5W x módulo
- Batería de Litio Autonomía 8hs*
- Protección IP44
- Materialidad ABS y PC



Incluye base de carga



Carga USB-C

CANDLE-N

- Potencia 0.5W x módulo
- Batería de Litio Autonomía 8hs*
- Protección IP44
- Materialidad ABS y PC



Incluye base de carga



Carga USB-C

*La autonomía es al 100% de la potencia dimerizada.

VELADORES A BATERÍA	TIPO DE LUZ		TENSIÓN	CORRIENTE	VIDA ÚTIL	TIEMPO DE CARGA	MASTER	VENTA MIN.	PRECIO SIN IVA
CANDLE-B	Cálida	2700K	5V	1A	25.000hs	3.5hs	12u.	1u.	46,89 USD
CANDLE-N	Cálida	2700K	5V	1A	25.000hs	3.5hs	12u.	1u.	45,66 USD
									IVA 21%

 Encendido táctil y dimerizable

 Blanco cálido 2700K

 Memoria de última función

 GARANTÍA 1 AÑO



FUNGUS

Carga USB-C

 Potencia 1.8W

 Batería de Litio. Autonomía 6hs*
*La autonomía es al 100% de la potencia dimerizada.

 Protección IP44

 Materialidad ABS y PC



BASEx3

**Compatible con modelos CANDLE (ByN) y FUNGUS.

 Potencia 10W

 Materialidad ABS

**El modelo de BASEx3 no incluye ningún modelo de velador.

VELADORES A BATERÍA	TIPO DE LUZ		TENSIÓN	CORRIENTE	VIDA ÚTIL	TIEMPO DE CARGA	MASTER	VENTA MIN.	PRECIO SIN IVA
FUNGUS-B	Cálida	2700K	5V	1A	25.000hs	2.5hs	24u.	1u.	18,35 USD
BASE-X3-B	-	-	5V	2A	-	-	12u.	1u.	25,67 USD
									IVA 21%



Encendido táctil y dimerizable



Blanco cálido 2700K



Memoria de última función

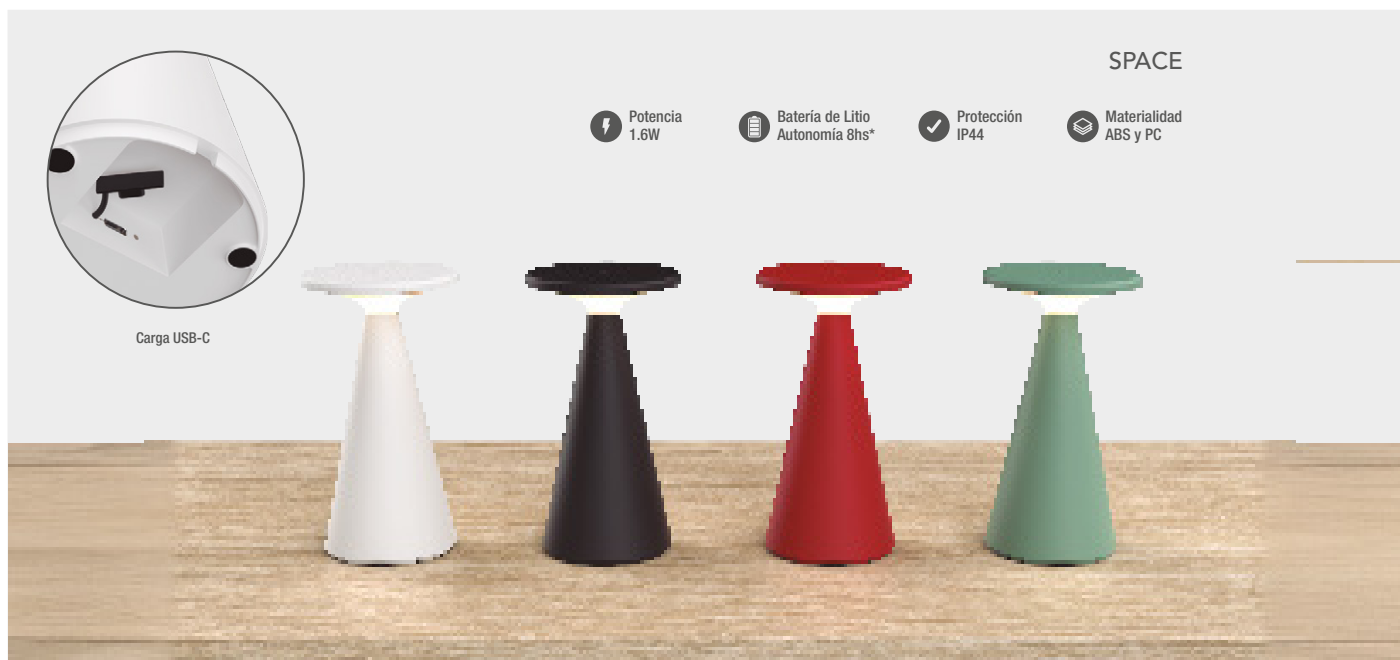

SPACE

⚡ Potencia 1.6W

🔋 Batería de Litio Autonomía 8hs*

✓ Protección IP44

📦 Materialidad ABS y PC

Carga USB-C

*La autonomía es al 100% de la potencia dimerizada.

VELADORES A BATERÍA	TIPO DE LUZ		TENSIÓN	CORRIENTE	VIDA ÚTIL	TIEMPO DE CARGA	MASTER	VENTA MIN.	PRECIO SIN IVA
SPACE-B	Cálida	2700K	5V	1A	25.000hs	4hs	12u.	1u.	31,05 USD
SPACE-N	Cálida	2700K	5V	1A	25.000hs	4hs	12u.	1u.	23,13 USD
SPACE-R	Cálida	2700K	5V	1A	25.000hs	4hs	12u.	1u.	31,05 USD
SPACE-V	Cálida	2700K	5V	1A	25.000hs	4hs	12u.	1u.	IVA 21%



MINERVA

⚡ Potencia 4W

🔋 Batería de Litio Autonomía 3hs*

✓ Protección IP20

📦 Materialidad ABS, Aluminio y PC

Carga USB-C

*La autonomía es al 100% de la potencia dimerizada.

VELADORES A BATERÍA	TIPO DE LUZ		TENSIÓN	CORRIENTE	VIDA ÚTIL	TIEMPO DE CARGA	MASTER	VENTA MIN.	PRECIO SIN IVA
MINERVA	Cálida	2700K	5V	1A	25.000hs	1,5hs	6u.	1u.	45,83 USD
									IVA 21%

MATERIAL DEL TUBO

NANO



TUBO LED NANO 9W T8 / 28x600mm					VIDA ÚTIL	PRECIO SIN IVA	
TNL-T8060WW	Cálido	3000°K	700lm	77 lm/W	30000hs	3,96 USD	
TNL-T8060NW	Neutro	4500°K	750lm	83 lm/W	30000hs		
TNL-T8060CW	Frío	6000°K	800lm	88 lm/W	30000hs		
TUBO LED NANO 18W T8 / 28x1195mm					VIDA ÚTIL	MASTER	PRECIO SIN IVA
TNL-T8120WW	Cálido	3000°K	1550lm	86 lm/W	30000hs	25u.	6,01 USD
TNL-T8120NW	Neutro	4500°K	1600lm	88 lm/W	30000hs	25u.	
TNL-T8120CW	Frío	6000°K	1650lm	91 lm/W	30000hs	25u.	

IVA 10,5%

MATERIAL DEL TUBO

VIDRIO



TUBO DE VIDRIO PRO



TUBO LED VIDRIO 9W T8 / 28x600mm					VIDA ÚTIL	MASTER	PRECIO SIN IVA
TL-T8060WW	Cálido	3000°K	700lm	77 lm/W	25.000hs	25u.	1,68 USD
TL-T8060NW	Neutro	4500°K	750lm	83 lm/W	25.000hs	25u.	
TL-T8060CW	Frío	6000°K	800lm	88 lm/W	25.000hs	25u.	
TUBO LED VIDRIO 12W T8 / 28x900mm					VIDA ÚTIL	MASTER	PRECIO SIN IVA
TL-T8090-12WW	Cálido	3000°K	1080lm	90 lm/W	25.000hs	25u.	2,32 USD
TL-T8090-12NW	Neutro	4500°K	1080lm	90 lm/W	25.000hs	25u.	
TL-T8090-12CW	Frío	6000°K	1080lm	90 lm/W	25.000hs	25u.	
TUBO LED VIDRIO 18W T8 / 28x1195mm					VIDA ÚTIL	MASTER	PRECIO SIN IVA
TL-T8120WW	Cálido	3000°K	1550lm	86 lm/W	25.000hs	25u.	2,02 USD
TL-T8120NW	Neutro	4500°K	1600lm	88 lm/W	25.000hs	25u.	
TL-T8120CW	Frío	6000°K	1650lm	91 lm/W	25.000hs	25u.	
TUBO LED VIDRIO 25W T8 / 28x1500mm					VIDA ÚTIL	MASTER	PRECIO SIN IVA
TL-T8150-25WW	Cálido	3000°K	2250lm	90 lm/W	25.000hs	25u.	3,98 USD
TL-T8150-25NW	Neutro	4500°K	2250lm	90 lm/W	25.000hs	25u.	
TL-T8150-25CW	Frío	6000°K	2250lm	90 lm/W	25.000hs	25u.	
TUBO LED VIDRIO PRO 18W T8 / 28x1200mm					VIDA ÚTIL	MASTER	PRECIO SIN IVA
TLP-T8120CW	Frío	6000°K	2160lm	120 lm/W	25.000hs	25u.	3,00 USD

IVA 10,5%

MATERIAL DEL TUBO

PVC+ALU



TUBO LED PVC+ALUMINIO 48W T8 / 25x2400mm					VIDA ÚTIL	MASTER	PRECIO SIN IVA
TPL-T8240-48-WW	Cálido	3000°K	3800lm	80 lm/W	25.000hs	20u.	23,18 USD
TPL-T8240-48-NW	Neutro	4500°K	3800lm	80 lm/W	25.000hs	20u.	
TPL-T8240-48CW	Frío	6000°K	3800lm	80 lm/W	25.000hs	20u.	

IVA 10,5%



Factor de
Potencia 0.95

Eficiencia
Lumínica de
120lm/W

Multitensión
100-240V



LUMINARIA LED ESTANCO 50W / 1200x78x66mm					PROTECCIÓN	MASTER	PRECIO SIN IVA
LEL-50-NW	Neutro	4500°K	6000lm	120 lm.xW	IP65	12u.	27,00 USD
LEL-50-CW	Frío	6500°K	6000lm	120 lm.xW	IP65	12u.	
							IVA 21%

PORTATUBO

SIMPLE



PORTATUBO

DOBLE



LISTÓN TUBO SIMPLE	TAMAÑO	CONECTOR	MATERIAL	MASTER	PRECIO SIN IVA
LT-060	60mm	G13	Aluminio	50u.	2,42 USD
LT-090	90mm	G13	Aluminio	50u.	2,87 USD
LT-120	120mm	G13	Aluminio	50u.	3,33 USD
LT-150	150mm	G13	Aluminio	25u.	4,76 USD
LT-240	240mm	G13	Aluminio	20u.	11,41 USD
					IVA 21%

LISTÓN TUBO DOBLE	TAMAÑO	CONECTOR	MATERIAL	MASTER	PRECIO SIN IVA
LTD-120	120cm	G13	Aluminio	50u.	3,60 USD
					IVA 21%



PORTATUBO
SIMPLE



PORTATUBO
DOBLE



ARTEFACTO ESTANCO 60CM				CONECTOR	PROTECCIÓN	MASTER	PRECIO SIN IVA
LET-1-60	Simple	Pot. Máx. 18W	670x66x62mm	G13	IP65	16u.	13,05 USD
LET-2-60	Doble	Pot. Máx. 36W	670x100x62mm	G13	IP65	12u.	15,70 USD
ARTEFACTO ESTANCO 120CM				CONECTOR	PROTECCIÓN	MASTER	PRECIO SIN IVA
LET-1-120	Simple	Pot. Máx. 18W	1270x66x62mm	G13	IP65	16u.	17,65 USD
LET-2-120	Doble	Pot. Máx. 36W	1270x100x62mm	G13	IP65	12u.	21,96 USD
IVA 21%							

PORTATUBO
PREMIUM
SIMPLE



PORTATUBO
PREMIUM
DOBLE



MÁS ILUMINACIÓN
Reflectante Premium



VISOR CRISTAL
Acrílico Cristal Premium

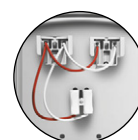

BORNERA A PRESIÓN
De fácil instalación

ARTEFACTO ESTANCO PREMIUM				CONECTOR	PROTECCIÓN	MASTER	PRECIO SIN IVA
LETP2-1-120/1	Simple	Pot. Máx. 18W	1265x89x92mm	G13	IP65	16u.	21,34 USD
LETP2-2-120	Doble	Pot. Máx. 36W	1265x130x92mm	G13	IP65	12u.	25,70 USD
IVA 21%							

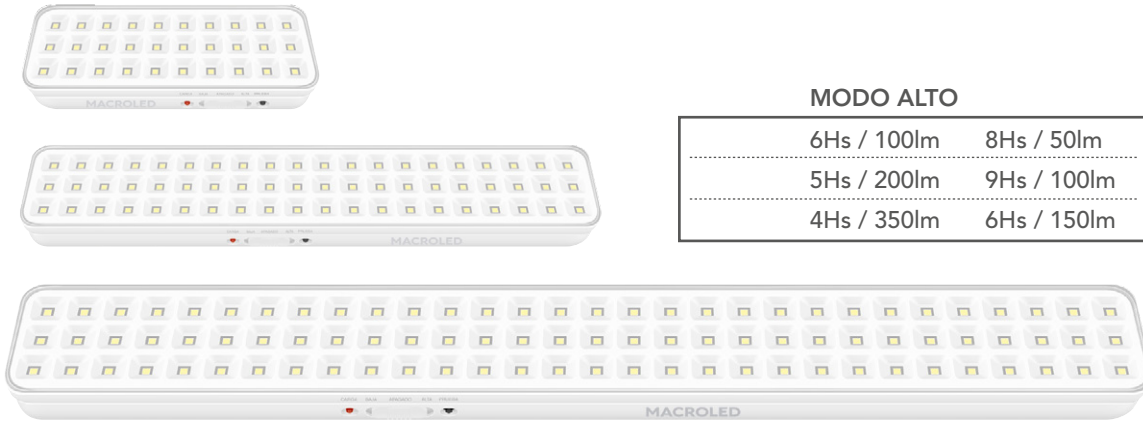

MODO ALTO

6Hs / 100lm	8Hs / 50lm
5Hs / 200lm	9Hs / 100lm
4Hs / 350lm	6Hs / 150lm

LUCES DE EMERGENCIA			POTENCIA	BATERÍA	MASTER	PRECIO SIN IVA
EML-30	Blanco Frío	6500°K	1.6W Máx.	Litio x1 3.7V 1.8aH	20u.	14,55 USD
EML-60	Blanco Frío	6500°K	3.2W Máx.	Litio x2 3.7V 1.8aH	10u.	25,66 USD
EML-90	Blanco Frío	6500°K	5.3W Máx.	Litio x2 3.7V 2.2aH	10u.	36,65 USD
						IVA 21%



BATERIA DE LITIO 65x18mm	TENSIÓN	CORRIENTE	INTER / MASTER	PRECIO SIN IVA
BL-3.7-1.8	3.7V	1800mA	10u. / 400u.	7,18 USD
BL-3.7-2.2	3.7V	2200mA	10u. / 400u.	8,11 USD
				IVA 21%



LUZ DE EMERGENCIA COB DE EMBUTIR 140x100mm		POTENCIA	FLUJO LUMINOSO	MASTER	VENTA MIN.	PRECIO SIN IVA
EML-COB-300	Blanco Frío	6500°K	3W	400lm	20u.	20u.
						34,04 USD
						IVA 21%

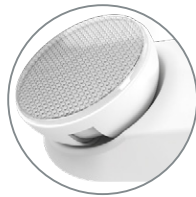

Gira 180°



Enchufe Incluido



Orificios para Empotar



Batería de Litio Recargable



Autonomía 3hs



Tensión AC100-240V



Vida Útil 50.000 hs



Protección IP20

LUZ DE EMERGENCIA TIPO MANTIS 270x78x110mm			POTENCIA	FLUJO LUMINOSO	MASTER	VENTA MIN.	PRECIO SIN IVA
EML-MT-400-I	Blanco Frío	7000°K	2W	400lm	10u.	1u.	30,00 USD
							IVA 21%



Botón de Testeo



MARCO PARA EMBUTIR



LUZ DE EMERGENCIA PARA APLICAR O EMBUTIR 65x18mm			POTENCIA	FLUJO LUMINOSO	MASTER	VENTA MIN.	PRECIO SIN IVA
EML-IP65-400	Blanco Frío	6500°K	2.5W	400lm	20u.	20u.	35,68 USD
EML-IP65-MARCO-EMBUTIR	-	-	-	-	20u.	20u.	5,46 USD
							IVA 21%



LINTERNA PRO 70X40mm	POTENCIA	LUMEN	MODOS	AUTONOMIA	INTER / MASTER	PRECIO SIN IVA
LMFP-120-3AAA	3W	120lm	100% / 30% / Estroboscópica	5hs	12u. / 72u.	6,76 USD IVA 21%



Mayor AUTONOMÍA
Con batería de litio de 3.7V 800mAh



PRODUCTO CERTIFICADO
IEC 60598-2-22
IEC 60598-1

ACCESORIOS INCLUIDOS



x2 tornillos
x2 tarugos

x2 accesorios
de suspensión

x2 accesorios
de fijación

1 Aplique superior

2 Aplique trasero

3 Aplique lateral

4 Aplique colgante

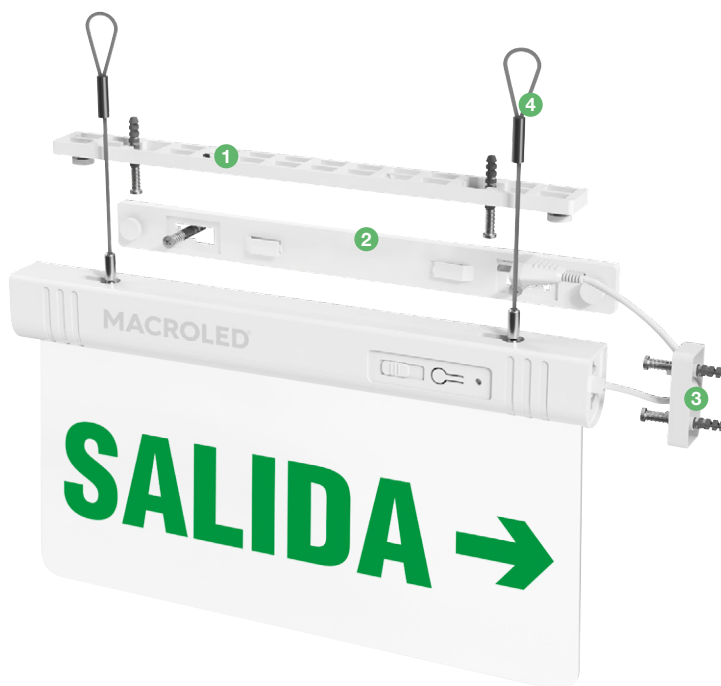

SEÑALES LUMINOSAS	POTENCIA	TENSIÓN	DIMENSIONES	MASTER	PRECIO SIN IVA
CSL-SALIDA 	1W Máx.	220-240V	192X356mm	10u.	25,86 USD
CSL-SAL-IZQ 	1W Máx.	220-240V	192X356mm	10u.	
CSL-SAL-DER 	1W Máx.	220-240V	192X356mm	10u.	
CSL-EMERGENCIA 	1W Máx.	220-240V	192X356mm	10u.	24,29 USD
CSL-EME-IZQ 	1W Máx.	220-240V	192X356mm	10u.	
CSL-EME-DER 	1W Máx.	220-240V	192X356mm	10u.	
CSL-PUERTA 	1W Máx.	220-240V	192X356mm	10u.	25,86 USD
CSL-ESCALERA 	1W Máx.	220-240V	192X356mm	10u.	
CSL-BANOS 	1W Máx.	220-240V	192X356mm	10u.	

IVA 21%

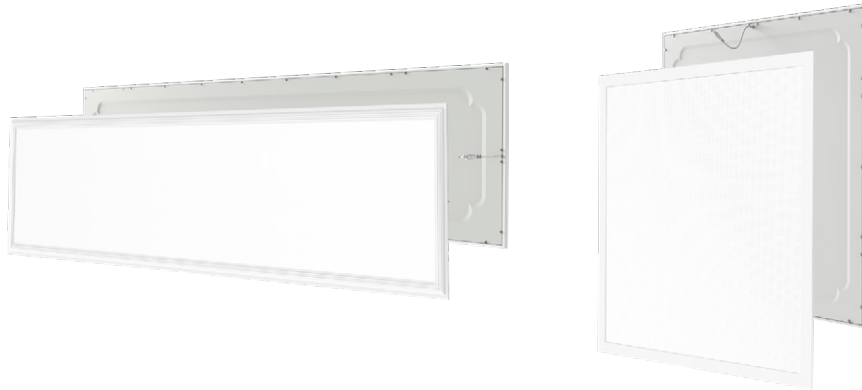

Potencia	40W	PRO 48W
Tamaño 30120	295x195mm	305x1205mm
Tamaño 6060	595x595mm	605x605mm
Tensión	AC100-260V	AC100-260V
Frecuencia	50-60Hz	50-60Hz
SDCM	5	5
Flujo Luminoso	3600lm	4800lm
Lúmenes x W	90lm x W	100lm x W
Flicker (parpadeo)	Si	No
LM80 - Certificación de LED	No	Si
EMC - Certificación Europea	No	Si
Material Lente	PS	PMMA
SPD	1500V	1500V
UGR - Anti encandilamiento	No	Si
Vida Útil	25.000	50.000
CRI	80	80
Protección	IP20	IP40
Factor Potencia	0.98	0.98
Driver	Aislado	Aislado
Masterbox	10	5
Garantía	2 Años	5 Años

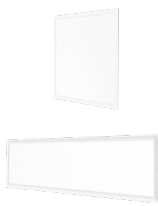

PANEL 40W				DIMENSIONES	MASTER	PRECIO SIN IVA
P40-595-PS-3600LM-WW	Cálido	3000°K	3600lm	595x595mm	10u.	33,00 USD
P40-595-PS-3600LM-NW	Neutro	4500°K	3600lm		10u.	
P40-595-PS-3600LM-CW	Frío	6000°K	3600lm		10u.	
P40-1195-PS-3600LM-WW	Cálido	3000°K	3600lm	295x1195mm	10u.	36,90 USD
P40-1195-PS-3600LM-NW	Neutro	4500°K	3600lm		10u.	
P40-1195-PS-3600LM-CW	Frío	6000°K	3600lm		10u.	
IVA 21%						



PANEL PRO 48W				DIMENSIONES	VENTA MIN.	PRECIO SIN IVA
P48-605-PMMA-4800LM-WW	Cálido	3000°K	4800lm	605x605mm	5u.	56,20 USD
P48-605-PMMA-4800LM-NW	Neutro	4500°K	4800lm		5u.	
P48-605-PMMA-4800LM-CW	Frío	6000°K	4800lm		5u.	
P48-1205-PMMA-4800LM-WW	Cálido	3000°K	4800lm	305x1205mm	5u.	65,00 USD
P48-1205-PMMA-4800LM-NW	Neutro	4500°K	4800lm		5u.	
P48-1205-PMMA-4800LM-CW	Frío	6000°K	4800lm		5u.	
IVA 21%						

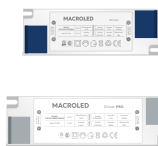

DRIVER				MASTER	VENTA MIN.	PRECIO SIN IVA
P40-595-PS-3600LM-DR	Panel 60x60	AC 110-260V, 03A	DC 50-70V 40W	100u.	1u.	5,82 USD
P40-1195-PS-3600LM-DR	Panel 30x120	AC 110-260V, 03A	DC 50-70V 40W	100u.	1u.	
P48-605-PMMA-4800LM-DR	Panel 60x60	AC 110-260V, 02A	DC 60-80V 48W	100u.	1u.	10,27 USD
P48-1205-PMMA-4800LM-DR	Panel 30x120	AC 110-260V, 02A	DC 60-80V 48W	100u.	1u.	
IVA 21%						



LOS PANELES NO INCLUYEN KITS DE FIJACIÓN.



ACCESORIOS PANELES		PANEL COMPATIBLE	PANEL ARMADO	INTER.	VENTA MIN.	PRECIO SIN IVA
PPLP6060	Plafón	595x595mm (40W)	600x600x50mm (40W)	-	20u.	16,18 USD
PPLP30120	Plafón	295x1195mm (40W)	300x1200x50mm (40W)	-	20u.	20,42 USD
PPLPL6060	Plafón PRO	605x605mm (48W)	610x610x50mm (48W)	-	20u.	16,37 USD
PPLPL30120	Plafón PRO	305x1205mm (48W)	310x1210x50mm (48W)	-	20u.	20,49 USD
						IVA 21%



ACCESORIOS PANELES		PANEL COMPATIBLE	PANEL ARMADO	INTER.	VENTA MIN.	PRECIO SIN IVA
AS-PANEL	Suspensión	Todos	-	100u.	20u.	5,11 USD
AE-PANEL	Embutido	Todos	-	100u.	20u.	2,07 USD
AF-PANEL	Fijación	Todos	-	100u.	20u.	3,55 USD
						IVA 21%



POTENCIA
36W

FLUJO LUMINOSO
4320lm

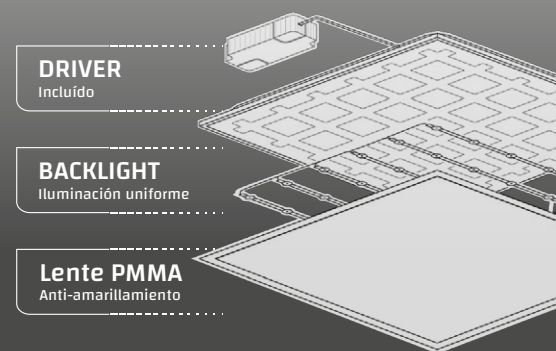

Rango de tensión
200-240V



Ángulo de apertura
110°



Factor de Potencia
0.98



Vida útil
50.000hs

5 AÑOS DE GARANTÍA

	PANEL LED BACKLIGHT - 60x60x3,3cm			POTENCIA	INTER.	MASTER	PRECIO SIN IVA
	SPBL-600X600-36W-WW	Cálido	3000°K	4320lm	36W	2u.	10u.
SPBL-600X600-36W-NW	Neutro	4500°K	4320lm	2u.		10u.	
SPBL-600X600-36W-CW	Frío	6000°K	4320lm	2u.		10u.	



PANEL COB 30W / 230x50mm					VIDA ÚTIL	VENTA MIN.	PRECIO SIN IVA
RTB30-WW	Cálido	3000°K	2500lm	83 lm/W	30000hs	10u.	43,27 USD
RTB30-NW	Neutro	4500°K	2700lm	90 lm/W	30000hs	10u.	
RTB30-CW	Frío	6000°K	2800lm	93 lm/W	30000hs	10u.	
							IVA 21%



DRIVER PARA PANEL COB 30W				MASTER	VENTA MIN.	PRECIO SIN IVA
RTB30DR	AC100-265V 50-60Hz	DC28-38V 0.18A 30W Máx		100u.	20u.	9,40 USD
						IVA 21%



PANEL COB DICRO MOVIL REDONDO 3W / 75x45mm					VIDA ÚTIL	MASTER	PRECIO SIN IVA
RTB3-WW	Cálido	3000°K	240lm	80 lm/W	25.000hs	50u.	4,43 USD
RTB3-CW	Frío	6000°K	260lm	86 lm/W	25.000hs	50u.	
							IVA 21%



PANEL COB DICRO MOVIL REDONDO 7W / 91,5x38mm					VIDA ÚTIL	MASTER	PRECIO SIN IVA
RTB7-WW	Cálido	3000°K	560lm	80 lm/W	25.000hs	50u.	5,52 USD
RTB7-CW	Frío	6000°K	595lm	86 lm/W	25.000hs	50u.	
							IVA 21%



PANEL COB DICRO MOVIL CUADRADO 3W / 75x45mm					VIDA ÚTIL	MASTER	PRECIO SIN IVA
STB3-WW	Cálido	3000°K	240lm	80 lm/W	25.000hs	50u.	4,48 USD
STB3-CW	Frío	6000°K	260lm	86 lm/W	25.000hs	50u.	
							IVA 21%



PANEL COB DICRO MOVIL CUADRADO 7W / 91,5x38mm					VIDA ÚTIL	MASTER	PRECIO SIN IVA
STB7-WW	Cálido	3000°K	560lm	80 lm/W	25.000hs	50u.	5,57 USD
STB7-CW	Frío	6000°K	595lm	86 lm/W	25.000hs	50u.	
							IVA 21%



PANEL EMBUTIR REDONDO					MEDIDAS	MASTER	PRECIO SIN IVA
PER06WW	6W	Cálido	3000°K	540lm	Ø118x18mm	40u.	4,14 USD
PER06NW	6W	Neutro	4500°K	540lm	Ø118x18mm	40u.	
PER06CW	6W	Frío	6000°K	540lm	Ø118x18mm	40u.	
PER12WW	12W	Cálido	3000°K	1080lm	Ø167x18mm	30u.	6,53 USD
PER12NW	12W	Neutro	4500°K	1080lm	Ø167x18mm	30u.	
PER12CW	12W	Frío	6000°K	1080lm	Ø167x18mm	30u.	
PER18WW	18W	Cálido	3000°K	1620lm	Ø221x18mm	30u.	8,61 USD
PER18NW	18W	Neutro	4500°K	1620lm	Ø221x18mm	30u.	
PER18CW	18W	Frío	6000°K	1620lm	Ø221x18mm	30u.	
PER24WW	24W	Cálido	3000°K	2160lm	Ø296x18mm	10u.	13,05 USD
PER24NW	24W	Neutro	4500°K	2160lm	Ø296x18mm	10u.	
PER24CW	24W	Frío	6000°K	2160lm	Ø296x18mm	10u.	
							IVA 21%

PANEL EMBUTIR CUADRADO					MEDIDAS	MASTER	PRECIO SIN IVA
PEC06WW	6W	Cálido	3000°K	540lm	116x116x18mm	40u.	4,34 USD
PEC06NW	6W	Neutro	4500°K	540lm	116x116x18mm	40u.	
PEC06CW	6W	Frío	6000°K	540lm	116x116x18mm	40u.	
PEC12WW	12W	Cálido	3000°K	1080lm	167x167x18mm	30u.	7,17 USD
PEC12NW	12W	Neutro	4500°K	1080lm	167x167x18mm	30u.	
PEC12CW	12W	Frío	6000°K	1080lm	167x167x18mm	30u.	
PEC18WW	18W	Cálido	3000°K	1620lm	219x219x18mm	30u.	9,84 USD
PEC18NW	18W	Neutro	4500°K	1620lm	219x219x18mm	30u.	
PEC18CW	18W	Frío	6000°K	1620lm	219x219x18mm	30u.	
PEC24WW	24W	Cálido	3000°K	2160lm	292x292x18mm	10u.	15,63 USD
PEC24NW	24W	Neutro	4500°K	2160lm	292x292x18mm	10u.	
PEC24CW	24W	Frío	6000°K	2160lm	292x292x18mm	10u.	
							IVA 21%



DRIVER DIMERIZABLE PARA PANELES 6W / 12W / 18W / 24W					MASTER	VENTA MIN.	PRECIO SIN IVA
PEC12-D-DR	6W y 12W	AC85-265V~, 50-60Hz	24-50Vcc, 180-300mA, 12W Máx.		100u.	20u.	7,80 USD
PEC24-D-DR	18W y 24W	AC85-265V~, 50-60Hz	54-84Vcc, 250-270mA, 24W Máx.		100u.	20u.	9,20 USD



DRIVER PARA PANELES 6W / 12W / 18W / 24W					MASTER	VENTA MIN.	PRECIO SIN IVA
PEC06DR	6W	AC85-265V~, 50-60Hz	DC12-24V, 240-260mA, 6W Máx.		100u.	20u.	2,33 USD
PEC12DR	12W	AC85-265V~, 50-60Hz	DC24-50V, 250-270mA, 12W Máx.		100u.	20u.	3,38 USD
PEC18DR	18W	AC85-265V~, 50-60Hz	DC36-63V, 270-290mA, 18W Máx.		100u.	20u.	4,05 USD
PEC24DR	24W	AC85-265V~, 50-60Hz	DC54-84V, 270-290mA, 24W Máx.		100u.	20u.	4,40 USD



DRIVER DE EMERGENCIA PARA PANELES 6W / 12W / 18W / 24W					MASTER	VENTA MIN.	PRECIO SIN IVA
PEC6-24DRB	AC85-265V~, 50-60Hz		DC57-68V, 270-290mA		100u.	10u.	11,18 USD
							IVA 21%



PANEL PLAFÓN REDONDO					MEDIDAS	MASTER	PRECIO SIN IVA
PR06WW	6W	Cálido	3000°K	540lm	Ø116x32mm	40u.	4,45 USD
PR06NW	6W	Neutro	4500°K	540lm	Ø116x32mm	40u.	
PR06CW	6W	Frío	6000°K	540lm	Ø116x32mm	40u.	
PR12WW	12W	Cálido	3000°K	1080lm	Ø165x32mm	30u.	7,02 USD
PR12NW	12W	Neutro	4500°K	1080lm	Ø165x32mm	30u.	
PR12CW	12W	Frío	6000°K	1080lm	Ø165x32mm	30u.	
PR18WW	18W	Cálido	3000°K	1620lm	Ø219x32mm	30u.	9,13 USD
PR18NW	18W	Neutro	4500°K	1620lm	Ø219x32mm	30u.	
PR18CW	18W	Frío	6000°K	1620lm	Ø219x32mm	30u.	
PR24WW	24W	Cálido	3000°K	2160lm	Ø295x32mm	10u.	14,18 USD
PR24NW	24W	Neutro	4500°K	2160lm	Ø295x32mm	10u.	
PR24CW	24W	Frío	6000°K	2160lm	Ø295x32mm	10u.	
							IVA 21%

PANEL PLAFÓN CUADRADO					MEDIDAS	MASTER	PRECIO SIN IVA
PC06WW	6W	Cálido	3000°K	540lm	116x116x32mm	40u.	5,03 USD
PC06NW	6W	Neutro	4500°K	540lm	116x116x32mm	40u.	
PC06CW	6W	Frío	6000°K	540lm	116x116x32mm	40u.	
PC12WW	12W	Cálido	3000°K	1080lm	165x165x32mm	30u.	7,65 USD
PC12NW	12W	Neutro	4500°K	1080lm	165x165x32mm	30u.	
PC12CW	12W	Frío	6000°K	1080lm	165x165x32mm	30u.	
PC18WW	18W	Cálido	3000°K	1620lm	219x219x32mm	30u.	10,34 USD
PC18NW	18W	Neutro	4500°K	1620lm	219x219x32mm	30u.	
PC18CW	18W	Frío	6000°K	1620lm	219x219x32mm	30u.	
PC24WW	24W	Cálido	3000°K	2160lm	295x295x32mm	10u.	15,88 USD
PC24NW	24W	Neutro	4500°K	2160lm	295x295x32mm	10u.	
PC24CW	24W	Frío	6000°K	2160lm	295x295x32mm	10u.	
							IVA 21%



DRIVER DIMERIZABLE PARA PANELES 6W / 12W / 18W / 24W					MASTER	VENTA MIN.	PRECIO SIN IVA
PEC12-D-DR	6W y 12W	AC85-265V~, 50-60Hz	24-50Vcc, 180-300mA, 12W Máx.		100u.	20u.	7,80 USD
PEC24-D-DR	18W y 24W	AC85-265V~, 50-60Hz	54-84Vcc, 250-270mA, 24W Máx.		100u.	20u.	9,20 USD



DRIVER PARA PANELES 6W / 12W / 18W / 24W					MASTER	VENTA MIN.	PRECIO SIN IVA
PEC06DR	6W	AC85-265V~, 50-60Hz	DC12-24V, 240-260mA, 6W Máx.		100u.	20u.	2,33 USD
PEC12DR	12W	AC85-265V~, 50-60Hz	DC24-50V, 250-270mA, 12W Máx.		100u.	20u.	3,38 USD
PEC18DR	18W	AC85-265V~, 50-60Hz	DC36-63V, 270-290mA, 18W Máx.		100u.	20u.	4,05 USD
PEC24DR	24W	AC85-265V~, 50-60Hz	DC54-84V, 270-290mA, 24W Máx.		100u.	20u.	4,40 USD



DRIVER DE EMERGENCIA PARA PANELES 6W / 12W / 18W / 24W					MASTER	VENTA MIN.	PRECIO SIN IVA
PEC6-24DRB	AC85-265V~, 50-60Hz		DC57-68V, 270-290mA		100u.	10u.	11,18 USD
							IVA 21%



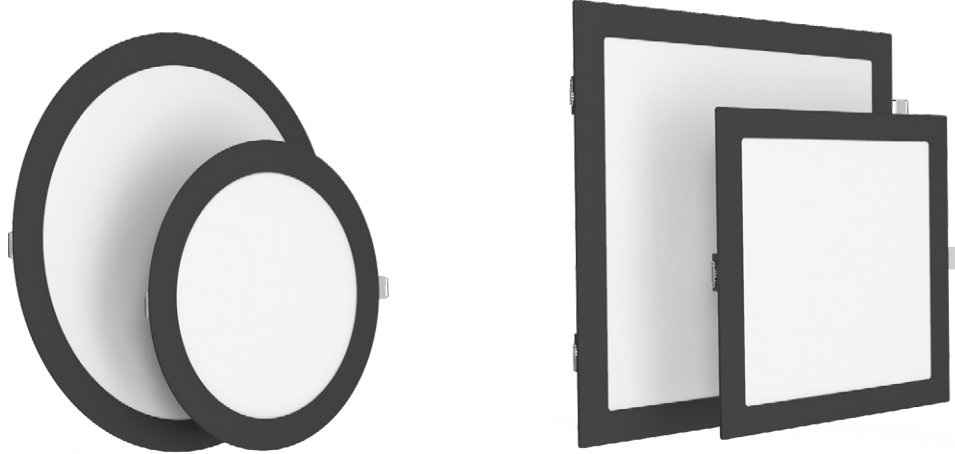

PANEL EMBUTIR REDONDO					MEDIDAS	MASTER	PRECIO SIN IVA
NPER18WW	18W	Cálido	3000°K	1600lm	Ø221x18mm	30u.	7,42 USD
NPER18NW	18W	Neutro	4500°K	1610lm	Ø221x18mm	30u.	
NPER18CW	18W	Frío	6000°K	1620lm	Ø221x18mm	30u.	
NPER24WW	24W	Cálido	3000°K	2140lm	Ø296x18mm	10u.	12,36 USD
NPER24NW	24W	Neutro	4500°K	2150lm	Ø296x18mm	10u.	
NPER24CW	24W	Frío	6000°K	2160lm	Ø296x18mm	10u.	

PANEL EMBUTIR CUADRADO					MEDIDAS	MASTER	PRECIO SIN IVA
NPEC18WW	18W	Cálido	3000°K	1600lm	219x219x18mm	30u.	8,22 USD
NPEC18NW	18W	Neutro	4500°K	1610lm	219x219x18mm	30u.	
NPEC18CW	18W	Frío	6000°K	1620lm	219x219x18mm	30u.	
NPEC24WW	24W	Cálido	3000°K	2140lm	292x219x18mm	10u.	13,22 USD
NPEC24NW	24W	Neutro	4500°K	2150lm	292x219x18mm	10u.	
NPEC24CW	24W	Frío	6000°K	2160lm	292x219x18mm	10u.	



DRIVER DIMERIZABLE PARA PANELES 6W / 12W / 18W / 24W				MASTER	VENTA MIN.	PRECIO SIN IVA
PEC12-D-DR	6W y 12W	AC85-265V~, 50-60Hz	24-50Vcc, 180-300mA, 12W Máx.	100u.	20u.	7,80 USD
PEC24-D-DR	18W y 24W	AC85-265V~, 50-60Hz	54-84Vcc, 250-270mA, 24W Máx.	100u.	20u.	9,20 USD

DRIVER PARA PANELES 6W / 12W / 18W / 24W				MASTER	VENTA MIN.	PRECIO SIN IVA
PEC06DR	6W	AC85-265V~, 50-60Hz	DC12-24V, 240-260mA, 6W Máx.	100u.	20u.	2,33 USD
PEC12DR	12W	AC85-265V~, 50-60Hz	DC24-50V, 250-270mA, 12W Máx.	100u.	20u.	3,38 USD
PEC18DR	18W	AC85-265V~, 50-60Hz	DC36-63V, 270-290mA, 18W Máx.	100u.	20u.	4,05 USD
PEC24DR	24W	AC85-265V~, 50-60Hz	DC54-84V, 270-290mA, 24W Máx.	100u.	20u.	4,40 USD

DRIVER DE EMERGENCIA PARA PANELES 6W / 12W / 18W / 24W			MASTER	VENTA MIN.	PRECIO SIN IVA
PEC6-24DRB	AC85-265V~, 50-60Hz	DC57-68V, 270-290mA	100u.	10u.	11,18 USD
IVA 21%					



PANEL PLAFÓN REDONDO BLACK SERIES					MEDIDAS	MASTER	PRECIO SIN IVA
NPR06WW	6W	Cálido	3000°K	510lm	Ø116x32mm	40u.	5,11 USD
NPR06CW	6W	Frío	6000°K	540lm	Ø116x32mm	40u.	
NPR12WW	12W	Cálido	3000°K	1020lm	Ø165x32mm	30u.	7,58 USD
NPR12CW	12W	Frío	6000°K	1080lm	Ø165x32mm	30u.	
NPR18WW	18W	Cálido	3000°K	1600lm	Ø219x32mm	30u.	9,66 USD
NPR18NW	18W	Neutro	4500°K	1610lm	Ø219x32mm	30u.	9,92 USD
NPR18CW	18W	Frío	6000°K	1620lm	Ø219x32mm	30u.	9,66 USD
NPR24WW	24W	Cálido	3000°K	2040lm	Ø295x32mm	10u.	15,40 USD
NPR24NW	24W	Neutro	4500°K	2150lm	Ø295x32mm	10u.	15,84 USD
NPR24CW	24W	Frío	6000°K	2160lm	Ø295x32mm	10u.	15,40 USD
							IVA 21%

PANEL PLAFÓN CUADRADO BLACK SERIES					MEDIDAS	MASTER	PRECIO SIN IVA
NPC06WW	6W	Cálido	3000°K	510lm	116x116x32mm	40u.	5,57 USD
NPC06CW	6W	Frío	6000°K	540lm	116x116x32mm	40u.	
NPC12WW	12W	Cálido	3000°K	1020lm	165x116x32mm	30u.	8,19 USD
NPC12CW	12W	Frío	6000°K	1080lm	165x116x32mm	30u.	
NPC18WW	18W	Cálido	3000°K	1600lm	219x219x32mm	30u.	10,83 USD
NPC18NW	18W	Neutro	4500°K	1610lm	219x219x32mm	30u.	
NPC18CW	18W	Frío	6000°K	1620lm	219x219x32mm	30u.	
NPC24WW	24W	Cálido	3000°K	2040lm	295x295x32mm	10u.	16,94 USD
NPC24NW	24W	Neutro	4500°K	2150lm	295x295x32mm	10u.	
NPC24CW	24W	Frío	6000°K	2160lm	295x295x32mm	10u.	
							IVA 21%



DRIVER DIMERIZABLE PARA PANELES 6W / 12W / 18W / 24W				MASTER	VENTA MIN.	PRECIO SIN IVA
PEC12-D-DR	6W y 12W	AC85-265V~, 50-60Hz	24-50Vcc, 180-300mA, 12W Máx.	100u.	20u.	7,80 USD
PEC24-D-DR	18W y 24W	AC85-265V~, 50-60Hz	54-84Vcc, 250-270mA, 24W Máx.	100u.	20u.	9,20 USD

DRIVER PARA PANELES 6W / 12W / 18W / 24W				MASTER	VENTA MIN.	PRECIO SIN IVA
PEC06DR	6W	AC85-265V~, 50-60Hz	DC12-24V, 240-260mA, 6W Máx.	100u.	20u.	2,33 USD
PEC12DR	12W	AC85-265V~, 50-60Hz	DC24-50V, 250-270mA, 12W Máx.	100u.	20u.	3,38 USD
PEC18DR	18W	AC85-265V~, 50-60Hz	DC36-63V, 270-290mA, 18W Máx.	100u.	20u.	4,05 USD
PEC24DR	24W	AC85-265V~, 50-60Hz	DC54-84V, 270-290mA, 24W Máx.	100u.	20u.	4,40 USD

DRIVER DE EMERGENCIA PARA PANELES 6W / 12W / 18W / 24W			MASTER	VENTA MIN.	PRECIO SIN IVA
PEC6-24DRB	AC85-265V~, 50-60Hz	DC57-68V, 270-290mA	100u.	10u.	11,18 USD
IVA 21%					

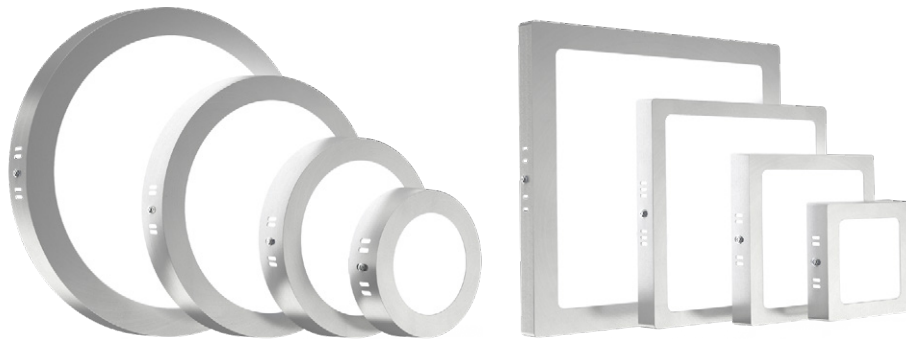

PANEL PLAFÓN REDONDO PLATIL SERIES					MEDIDAS	MASTER	PRECIO SIN IVA
PPR06WW	6W	Cálido	3000°K	510lm	Ø116x32mm	40u.	7,06 USD
PPR06CW	6W	Frío	6000°K	540lm	Ø116x32mm	40u.	
PPR12WW	12W	Cálido	3000°K	1020lm	Ø165x32mm	30u.	10,69 USD
PPR12CW	12W	Frío	6000°K	1080lm	Ø165x32mm	30u.	
PPR18WW	18W	Cálido	3000°K	1530lm	Ø219x32mm	30u.	14,00 USD
PPR18CW	18W	Frío	6000°K	1620lm	Ø219x32mm	30u.	
PPR24WW	24W	Cálido	3000°K	2040lm	Ø295x32mm	10u.	21,58 USD
PPR24CW	24W	Frío	6000°K	2160lm	Ø295x32mm	10u.	
							IVA 21%

PANEL PLAFÓN CUADRADO PLATIL SERIES					MEDIDAS	MASTER	PRECIO SIN IVA
PPC06WW	6W	Cálido	3000°K	510lm	116x116x32mm	40u.	7,82 USD
PPC06CW	6W	Frío	6000°K	540lm	116x116x32mm	40u.	
PPC12WW	12W	Cálido	3000°K	1020lm	165x165x32mm	30u.	11,78 USD
PPC12CW	12W	Frío	6000°K	1080lm	165x165x32mm	30u.	
PPC18WW	18W	Cálido	3000°K	1530lm	219x219x32mm	30u.	15,52 USD
PPC18CW	18W	Frío	6000°K	1620lm	219x219x32mm	30u.	
PPC24WW	24W	Cálido	3000°K	2040lm	295x295x32mm	10u.	23,86 USD
PPC24CW	24W	Frío	6000°K	2160lm	295x295x32mm	10u.	
							IVA 21%



DRIVER DIMERIZABLE PARA PANELES 6W / 12W / 18W / 24W				MASTER	VENTA MIN.	PRECIO SIN IVA
PEC12-D-DR	6W y 12W	AC85-265V~, 50-60Hz	24-50Vcc, 180-300mA, 12W Máx.	100u.	20u.	7,80 USD
PEC24-D-DR	18W y 24W	AC85-265V~, 50-60Hz	54-84Vcc, 250-270mA, 24W Máx.	100u.	20u.	9,20 USD



DRIVER PARA PANELES 6W / 12W / 18W / 24W				MASTER	VENTA MIN.	PRECIO SIN IVA
PEC06DR	6W	AC85-265V~, 50-60Hz	DC12-24V, 240-260mA, 6W Máx.	100u.	20u.	2,33 USD
PEC12DR	12W	AC85-265V~, 50-60Hz	DC24-50V, 250-270mA, 12W Máx.	100u.	20u.	3,38 USD
PEC18DR	18W	AC85-265V~, 50-60Hz	DC36-63V, 270-290mA, 18W Máx.	100u.	20u.	4,05 USD
PEC24DR	24W	AC85-265V~, 50-60Hz	DC54-84V, 270-290mA, 24W Máx.	100u.	20u.	4,40 USD



DRIVER DE EMERGENCIA PARA PANELES 6W / 12W / 18W / 24W			MASTER	VENTA MIN.	PRECIO SIN IVA
PEC6-24DRB	AC85-265V~, 50-60Hz	DC57-68V, 270-290mA	100u.	10u.	11,18 USD
IVA 21%					



DRIVER



BATERÍA



P4048-DE 48W 183x45x33mm				MASTER VENTA MIN.	PRECIO SIN IVA
P4048-DE	48W	AC180-260V, 50-60Hz	65-72V, 580-620mA	24u.	48,72 USD
					IVA 21%

CIRCUITO DE CONEXIONADO

> Fácil reemplazo de batería

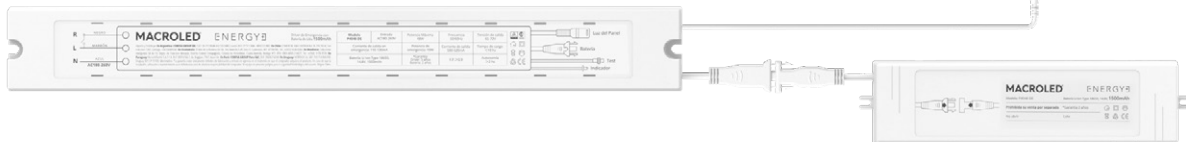
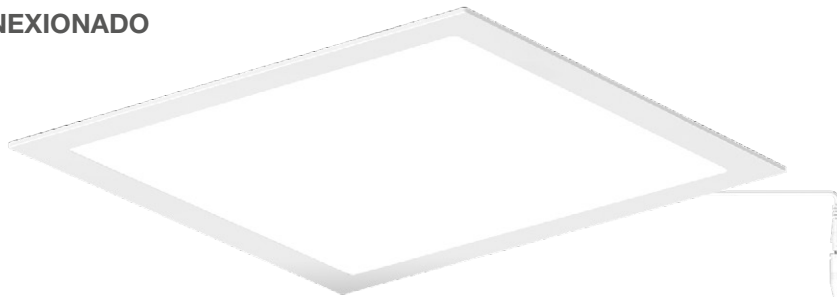

> Detalle del DRIVER





T5 LISTÓN LED 5W / 460x26x35mm					MEDIDAS	MASTER	VENTA MIN.	PRECIO SIN IVA
T5-30-5W-WW	Cálido	3000°K	450lm	90 lm/W	460x26x35mm	100u.	10u.	8,49 USD IVA 21%
T5-30-5W-CW	Frío	6500°K	450lm	90 lm/W	460x26x35mm	100u	10u.	

T5 LISTÓN LED 9W / 760x26x35mm					MEDIDAS	MASTER	VENTA MIN.	PRECIO SIN IVA
T5-60-9W-WW	Cálido	3000°K	810lm	90 lm/W	760x26x35mm	50u.	10u.	9,57 USD IVA 21%
T5-60-9W-CW	Frío	6500°K	810lm	90 lm/W	760x26x35mm	50u.	10u.	

T5 LISTÓN LED 13W / 1060x26x35mm					MEDIDAS	MASTER	VENTA MIN.	PRECIO SIN IVA
T5-90-13W-WW	Cálido	3000°K	1170lm	90 lm/W	1060x26x35mm	50u.	10u.	10,71 USD IVA 21%
T5-90-13W-CW	Frío	6500°K	1170lm	90 lm/W	1060x26x35mm	50u.	10u.	

T5 LISTÓN LED 18W / 1360x26x35mm					MEDIDAS	MASTER	VENTA MIN.	PRECIO SIN IVA
T5-120-18W-WW	Cálido	3000°K	1620lm	90 lm/W	1360x26x35mm	50u.	10u.	11,74 USD IVA 21%
T5-120-18W-CW	Frío	6500°K	1620lm	90 lm/W	1360x26x35mm	50u.	10u.	

SKYLINE MACROLED®

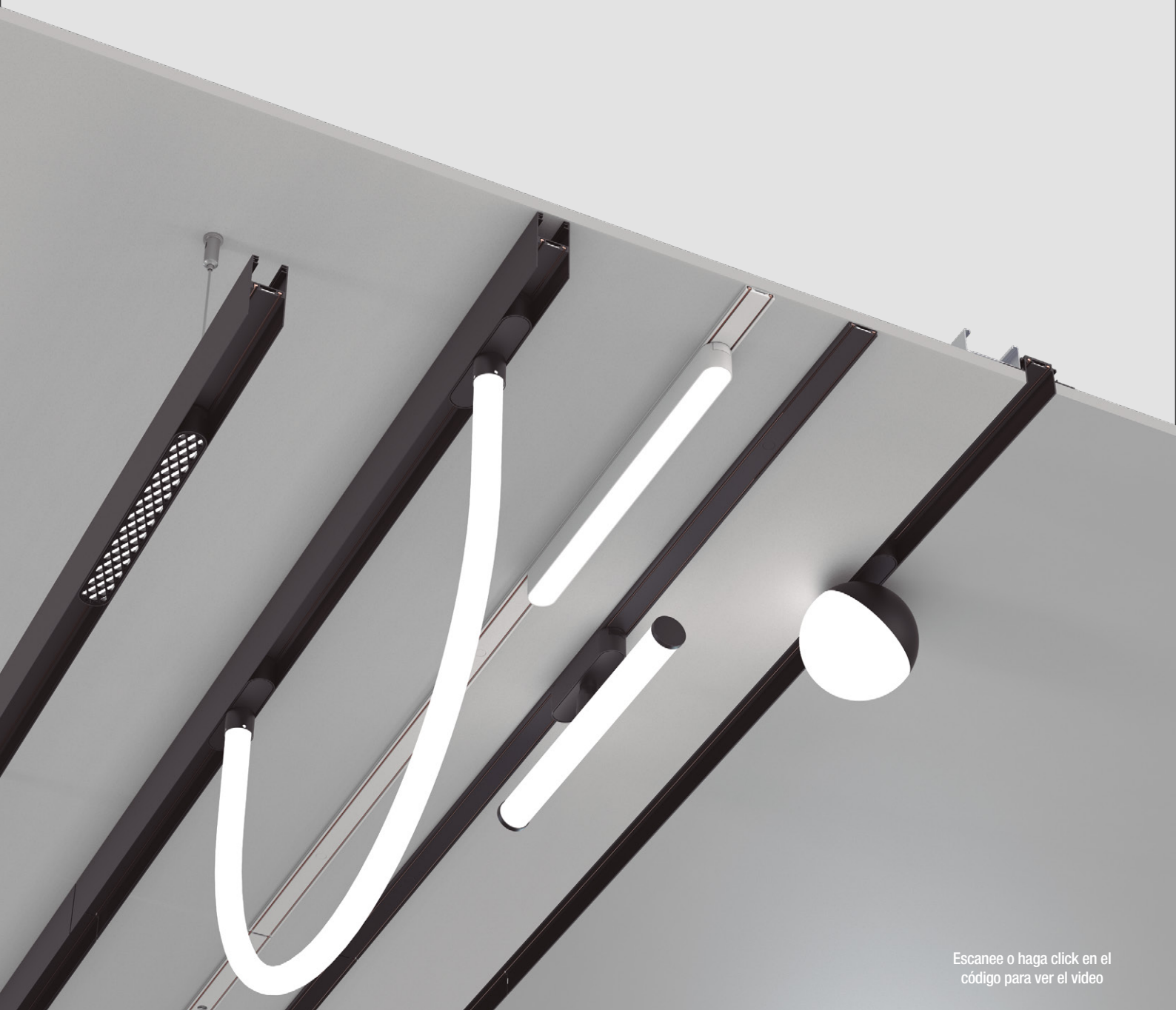

Escanee o haga click en el
código para ver el video

Apliques



Difuso

Focal

Panal



Dimerizable
con fuente

ACCESORIO MÓVIL

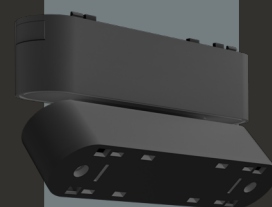

Adicioná un eje de rotación
de 90° a tus cabezales de
11 y 22cm

CABEZAL DIFUSO	ÁNGULO	TEMPCOLOR	LARGO	POTENCIA	LÚMENES	MASTER	VENTA MIN.	PRECIO SIN IVA
RMS-CD114-N-6W-WW	Difuso 90°	Blanco Cálido 2700K	11cm	6W	240lm	50u.	1u.	18,45 USD
RMS-CD222-N-12W-WW			22cm	12W	500lm	50u.	1u.	25,99 USD
RMS-CD330-N-16W-WW			33cm	16W	640lm	50u.	1u.	36,16 USD

CABEZAL FOCAL	ÁNGULO	TEMPCOLOR	LARGO	POTENCIA	LÚMENES	MASTER	VENTA MIN.	PRECIO SIN IVA
RMS-CF114-N-6W-WW	Focal 36°	Blanco Cálido 2700K	11cm	6W	390lm	50u.	1u.	21,62 USD
RMS-CF222-N-12W-WW			22cm	12W	880lm	50u.	1u.	33,69 USD
RMS-CF330-N-16W-WW			33cm	16W	1040lm	50u.	1u.	43,40 USD

CABEZAL PANAL	ÁNGULO	TEMPCOLOR	LARGO	POTENCIA	LÚMENES	MASTER	VENTA MIN.	PRECIO SIN IVA
RMS-CP114-N-6W-WW	Panal 60°	Blanco Cálido 2700K	11cm	6W	70lm	50u.	1u.	18,79 USD
RMS-CP222-N-12W-WW			22cm	12W	160lm	50u.	1u.	24,48 USD
RMS-CP330-N-16W-WW			33cm	16W	210lm	50u.	1u.	33,84 USD

MÓDULOS MÓVILES PARA CABEZALES	DIMENSIONES	LÚMENES	MASTER	INTERMEDIA	VENTA MIN.	PRECIO SIN IVA
RMS-MM-N-6W	11cm	6W	50u.	12u.	1u.	13,23 USD
RMS-MM-N-12W	22cm	12W	50u.	12u.	1u.	17,21 USD

IVA 21%

Apliques

SMART

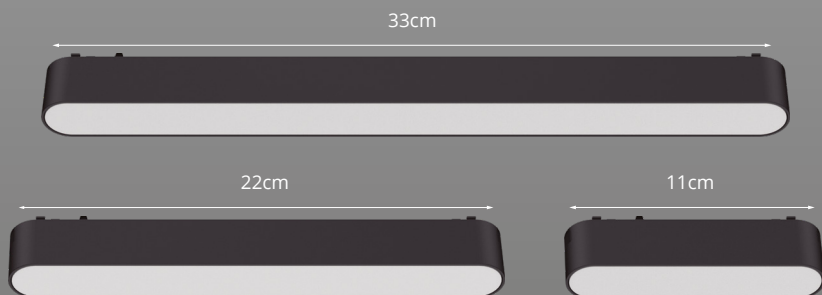

ACCESORIO MÓVIL

Adicioná un eje de rotación de 90° a tus cabezales de 11 y 22cm



Dimerizable con App



Cambio de Temperatura con App



CABEZAL DIFUSO	ÁNGULO	TEMP.COLOR	LARGO	POTENCIA	LÚMENES	MASTER	VENTA MIN.	PRECIO SIN IVA
RMS-S-CD114-N-6W	Difuso 90°	2000K-5000K	11cm	6W	240lm	50u.	1u.	47,35 USD
RMS-S-CD222-N-12W			22cm	12W	500lm	50u.	1u.	55,49 USD
RMS-S-CD330-N-16W			33cm	16W	640lm	50u.	1u.	66,70 USD

CABEZAL FOCAL	ÁNGULO	TEMP.COLOR	LARGO	POTENCIA	LÚMENES	MASTER	VENTA MIN.	PRECIO SIN IVA
RMS-S-CF114-N-6W	Focal 36°	2000K-5000K	11cm	6W	390lm	50u.	1u.	50,98 USD
RMS-S-CF222-N-12W			22cm	12W	880lm	50u.	1u.	62,87 USD
RMS-S-CF330-N-16W			33cm	16W	1040lm	50u.	1u.	78,32 USD

CABEZAL PANEL	ÁNGULO	TEMP.COLOR	LARGO	POTENCIA	LÚMENES	MASTER	VENTA MIN.	PRECIO SIN IVA
RMS-S-CP114-N-6W	Panel 60°	2000K-5000K	11cm	6W	70lm	50u.	1u.	47,64 USD
RMS-S-CP222-N-12W			22cm	12W	160lm	50u.	1u.	55,92 USD
RMS-S-CP330-N-16W			33cm	16W	210lm	50u.	1u.	67,61 USD

MÓDULOS MÓVILES PARA CABEZALES	DIMENSIONES	LÚMENES	MASTER	INTERMEDIA	VENTA MIN.	PRECIO SIN IVA
RMS-MM-N-6W	11cm	6W	50u.	12u.	1u.	15,19 USD
RMS-MM-N-12W	22cm	12W	50u.	12u.	1u.	15,14 USD

IVA 21%

Apliques

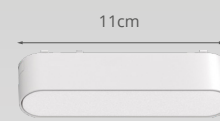
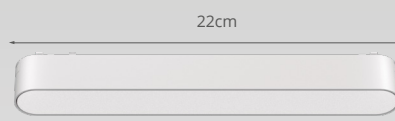
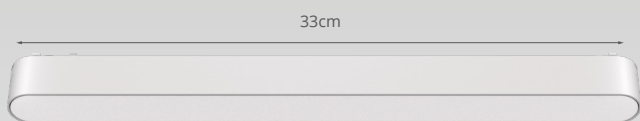

Difuso

Focal

Panal

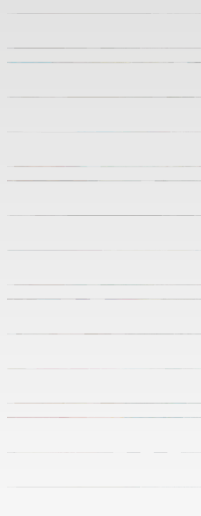

Dimerizable
con fuente

ACCESORIO MÓVIL

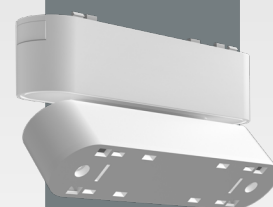

Adicioná un eje de rotación
de 90° a tus cabezales de
11 y 22cm

CABEZAL DIFUSO	ÁNGULO	TEMPCOLOR	LARGO	POTENCIA	LÚMENES	MASTER	VENTA MIN.	PRECIO SIN IVA
RMS-CD114-B-6W-WW	Difuso 90°	Blanco Cálido 2700K	11cm	6W	240lm	50u.	1u.	20,38 USD
RMS-CD222-B-12W-WW			22cm	12W	500lm	50u.	1u.	25,99 USD
RMS-CD330-B-16W-WW			33cm	16W	640lm	50u.	1u.	36,16 USD

CABEZAL FOCAL	ÁNGULO	TEMPCOLOR	LARGO	POTENCIA	LÚMENES	MASTER	VENTA MIN.	PRECIO SIN IVA
RMS-CF114-B-6W-WW	Focal 36°	Blanco Cálido 2700K	11cm	6W	390lm	50u.	1u.	21,62 USD
RMS-CF222-B-12W-WW			22cm	12W	880lm	50u.	1u.	30,54 USD
RMS-CF330-B-16W-WW			33cm	16W	1040lm	50u.	1u.	43,40 USD

CABEZAL PANAL	ÁNGULO	TEMPCOLOR	LARGO	POTENCIA	LÚMENES	MASTER	VENTA MIN.	PRECIO SIN IVA
RMS-CP114-B-6W-WW	Panal 60°	Blanco Cálido 2700K	11cm	6W	70lm	50u.	1u.	18,79 USD
RMS-CP222-B-12W-WW			22cm	12W	160lm	50u.	1u.	24,48 USD
RMS-CP330-B-16W-WW			33cm	16W	210lm	50u.	1u.	33,84 USD

MÓDULOS MÓVILES PARA CABEZALES	LARGO	POTENCIA	MASTER	INTERMEDIA	VENTA MIN.	PRECIO SIN IVA
RMS-MM-B-6W	11cm	6W	50u.	12u.	1u.	15,19 USD
RMS-MM-B-12W	22cm	12W	50u.	12u.	1u.	15,14 USD

IVA 21%

Apliques

SMART

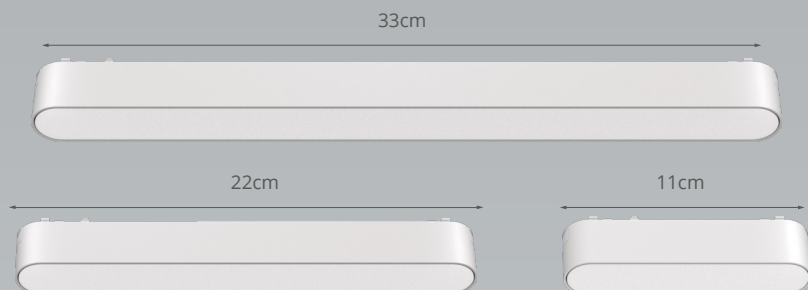

ACCESORIO MÓVIL



Adicioná un eje de rotación de 90° a tus cabezales de 11 y 22cm

Difuso

Focal

Panal



Dimerizable con App

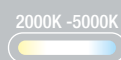

2000K - 5000K

Cambio de Temperatura con App



DISPONIBLE EN Google Play

Consíguelo en el App Store

CABEZAL DIFUSO	ÁNGULO	TEMP.COLOR	LARGO	POTENCIA	LÚMENES	MASTER	VENTA MIN.	PRECIO SIN IVA
RMS-S-CD114-B-6W	Difuso 90°	2000K-5000K	11cm	6W	240lm	50u.	1u.	47,35 USD
RMS-S-CD222-B-12W			22cm	12W	500lm	50u.	1u.	55,49 USD
RMS-S-CD330-B-16W			33cm	16W	640lm	50u.	1u.	66,70 USD

CABEZAL FOCAL	ÁNGULO	TEMP.COLOR	LARGO	POTENCIA	LÚMENES	MASTER	VENTA MIN.	PRECIO SIN IVA
RMS-S-CF114-B-6W	Focal 36°	2000K-5000K	11cm	6W	390lm	50u.	1u.	50,98 USD
RMS-S-CF222-B-12W			22cm	12W	880lm	50u.	1u.	62,87 USD
RMS-S-CF330-B-16W			33cm	16W	1040lm	50u.	1u.	78,32 USD

CABEZAL PANAL	ÁNGULO	TEMP.COLOR	LARGO	POTENCIA	LÚMENES	MASTER	VENTA MIN.	PRECIO SIN IVA
RMS-S-CP114-B-6W	Panal 60°	2000K-5000K	11cm	6W	70lm	50u.	1u.	47,64 USD
RMS-S-CP222-B-12W			22cm	12W	160lm	50u.	1u.	55,92 USD
RMS-S-CP330-B-16W			33cm	16W	210lm	50u.	1u.	67,61 USD

MÓDULOS MÓVILES PARA CABEZALES	LARGO	POTENCIA	MASTER	INTERMEDIA	VENTA MIN.	PRECIO SIN IVA
RMS-MM-B-6W	11cm	6W	50u.	12u.	1u.	13,23 USD
RMS-MM-B-12W	22cm	12W	50u.	12u.	1u.	17,21 USD

IVA 21%

Spot Móvil

SKYLINE



SPOT MÓVIL			TEMPCOLOR	MODELO	ÁNGULO	MASTER	VENTA MIN.	PRECIO SIN IVA
Simple 5W	9cm	275lm	Blanco Cálido 2700K	RMS-CM-N-5W-15G-WW	15°	30u.	1u.	28,50 USD
				RMS-CM-N-5W-24G-WW	24°	30u.	1u.	
				RMS-CM-N-5W-36G-WW	36°	30u.	1u.	
Doble 10W	9cm	700lm	Blanco Cálido 2700K	RMS-CMD-N-10W-15G-WW	15°	30u.	1u.	51,05 USD
				RMS-CMD-N-10W-24G-WW	24°	30u.	1u.	
				RMS-CMD-N-10W-36G-WW	36°	30u.	1u.	
Simple 7W	14cm	370lm	Blanco Cálido 2700K	RMS-CM-N-7W-15G-WW	15°	30u.	1u.	31,87 USD
				RMS-CM-N-7W-24G-WW	24°	30u.	1u.	
				RMS-CM-N-7W-36G-WW	36°	30u.	1u.	
Doble 14W	14cm	980lm	Blanco Cálido 2700K	RMS-CMD-N-14W-15G-WW	15°	30u.	1u.	57,62 USD
				RMS-CMD-N-14W-24G-WW	24°	30u.	1u.	
				RMS-CMD-N-14W-36G-WW	36°	30u.	1u.	
Simple 12W	13cm	840lm	Blanco Cálido 2700K	RMS-CM-N-12W-15G-WW	15°	30u.	1u.	38,48 USD
				RMS-CM-N-12W-24G-WW	24°	30u.	1u.	
				RMS-CM-N-12W-36G-WW	36°	30u.	1u.	
Simple 15W	17cm	1050lm	Blanco Cálido 2700K	RMS-CM-N-15W-15G-WW	15°	30u.	1u.	45,23 USD
				RMS-CM-N-15W-24G-WW	24°	30u.	1u.	
				RMS-CM-N-15W-36G-WW	36°	30u.	1u.	

IVA 21%

Spot Móvil

SMART

SKYLINE



SPOT MÓVIL	LARGO	LÚMENES	TEMPCOLOR	MODELO	ÁNGULO	MASTER	VENTA MIN.	PRECIO SIN IVA
Simple 5W	9cm	275lm	2000K-5000K	RMS-S-CM-N-5W-24G	24°	30u.	1u.	57,02 USD
Doble 10W	9cm	700lm	2000K-5000K	RMS-S-CMD-N-10W-24G	24°	30u.	1u.	84,99 USD
Simple 7W	14cm	370lm	2000K-5000K	RMS-S-CM-N-7W-24G	24°	30u.	1u.	63,26 USD
Doble 14W	14cm	980lm	2000K-5000K	RMS-S-CMD-N-14W-24G	24°	30u.	1u.	89,89 USD
Simple 12W	13cm	840lm	2000K-5000K	RMS-S-CM-N-12W-24G	24°	30u.	1u.	71,55 USD
Simple 15W	17cm	1050lm	2000K-5000K	RMS-S-CM-N-15W-24G	24°	30u.	1u.	76,70 USD

IVA 21%



SPOT MÓVIL	LARGO	TEMPCOLOR	MODELO	ÁNGULO	MASTER	VENTA MIN.	PRECIO SIN IVA
Simple 5W	9cm	275lm	RMS-CM-B-5W-15G-WW	15°	30u.	1u.	28,50 USD
			RMS-CM-B-5W-24G-WW	24°	30u.	1u.	
			RMS-CM-B-5W-36G-WW	36°	30u.	1u.	
Doble 10W	9cm	700lm	RMS-CMD-B-10W-15G-WW	15°	30u.	1u.	51,05 USD
			RMS-CMD-B-10W-24G-WW	24°	30u.	1u.	
			RMS-CMD-B-10W-36G-WW	36°	30u.	1u.	
Simple 7W	14cm	370lm	RMS-CM-B-7W-15G-WW	15°	30u.	1u.	31,87 USD
			RMS-CM-B-7W-24G-WW	24°	30u.	1u.	
			RMS-CM-B-7W-36G-WW	36°	30u.	1u.	
Doble 14W	14cm	980lm	RMS-CMD-B-14W-15G-WW	15°	30u.	1u.	57,62 USD
			RMS-CMD-B-14W-24G-WW	24°	30u.	1u.	
			RMS-CMD-B-14W-36G-WW	36°	30u.	1u.	
Simple 12W	13cm	840lm	RMS-CM-B-12W-15G-WW	15°	30u.	1u.	40,80 USD
			RMS-CM-B-12W-24G-WW	24°	30u.	1u.	
			RMS-CM-B-12W-36G-WW	36°	30u.	1u.	
Simple 15W	17cm	1050lm	RMS-CM-B-15W-15G-WW	15°	30u.	1u.	45,11 USD
			RMS-CM-B-15W-24G-WW	24°	30u.	1u.	
			RMS-CM-B-15W-36G-WW	36°	30u.	1u.	

IVA 21%

Spot Móvil

SMART

SKYLINE



SPOT MÓVIL	LARGO	LÚMENES	TEMPCOLOR	MODELO	ÁNGULO	MASTER	VENTA MIN.	PRECIO SIN IVA
Simple 5W	9cm	275lm	2000K-5000K	RMS-S-CM-B-5W-24G	24°	30u.	1u.	57,02 USD
Doble 10W	9cm	700lm	2000K-5000K	RMS-S-CMD-B-10W-24G	24°	30u.	1u.	84,99 USD
Simple 7W	14cm	370lm	2000K-5000K	RMS-S-CM-B-7W-24G	24°	30u.	1u.	63,26 USD
Doble 14W	14cm	980lm	2000K-5000K	RMS-S-CMD-B-14W-24G	24°	30u.	1u.	89,89 USD
Simple 12W	13cm	840lm	2000K-5000K	RMS-S-CM-B-12W-24G	24°	30u.	1u.	71,55 USD
Simple 15W	17cm	1050lm	2000K-5000K	RMS-S-CM-B-15W-24G	24°	30u.	1u.	76,70 USD

IVA 21%

Colgante
TUBular

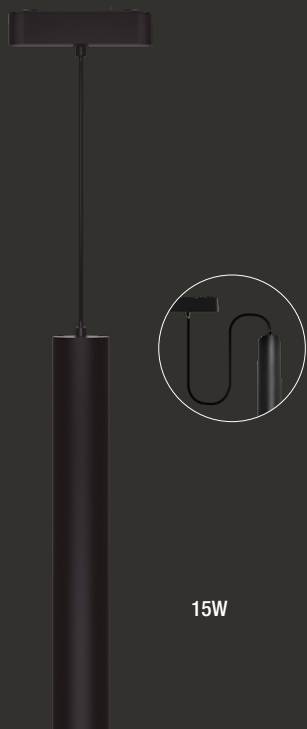

15W

Colgante Esférico
Difuso



10W

Colgante Esférico
Focal



12W

COLGANTE TUBULAR	TEMP.COLOR	LARGO	POTENCIA	LÚMENES	ÁNGULO	MASTER	VENTA MIN.	PRECIO SIN IVA
RMS-CC-N-9W-24G-WW	Blanco Cálido 2700K	100cm	9W	450lm	24°	20u.	1u.	41,37 USD
RMS-CC-N-9W-36G-WW		100cm	9W	450lm	36°	20u.	1u.	41,37 USD
RMS-CC-N-15W-15G-WW		100cm	15W	750lm	15°	30u.	1u.	48,85 USD
RMS-CC-N-15W-24G-WW		100cm	15W	750lm	24°	30u.	1u.	48,85 USD
RMS-CC-N-15W-36G-WW		100cm	15W	750lm	36°	30u.	1u.	48,85 USD
COLGANTE ESFÉRICO DIFUSO	TEMP.COLOR	LARGO	POTENCIA	LÚMENES	ÁNGULO	MASTER	VENTA MIN.	PRECIO SIN IVA
RMS-CED-N-10W-WW	Cálido 2700K	100cm	10W	700lm	120°	20u.	1u.	75,62 USD
APLIQUE ESFÉRICO DIFUSO	TEMP.COLOR	LARGO	POTENCIA	LÚMENES	ÁNGULO	MASTER	VENTA MIN.	PRECIO SIN IVA
RMS-AED-N-10W-WW	Cálido 2700K	11cm	10W	700lm	120°	20u.	1u.	75,62 USD
COLGANTE ESFÉRICO FOCAL	TEMP.COLOR	LARGO	POTENCIA	LÚMENES	ÁNGULO	MASTER	VENTA MIN.	PRECIO SIN IVA
RMS-CEF-N-12W-WW	Cálido 2700K	100cm	12W	780lm	24°	20u.	1u.	58,97 USD
APLIQUE ESFÉRICO FOCAL	TEMP.COLOR	LARGO	POTENCIA	LÚMENES	ÁNGULO	MASTER	VENTA MIN.	PRECIO SIN IVA
RMS-AEF-N-12W-24G-WW	Blanco Cálido 2700K	11cm	12W	780lm	24°	20u.	1u.	58,97 USD
RMS-AEF-N-12W-36G-WW		11cm	12W	780lm	36°	20u.	1u.	58,97 USD

IVA 21%

Colgante TUBular

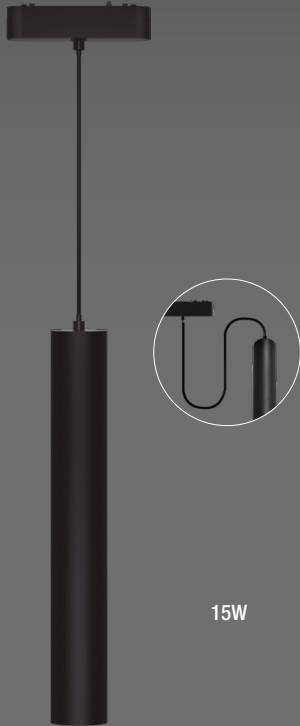

15W

Colgante Esférico Difuso



10W

Colgante Esférico Focal



12W



Dimerizable con App

2000K -5000K



Cambio de Temperatura con App



DISPONIBLE EN Google Play

Consíguelo en el App Store



COLGANTE TUBULAR		TEMP.COLOR	LARGO	POTENCIA	LÚMENES	ÁNGULO	MASTER	VENTA MIN.	PRECIO SIN IVA
RMS-S-CC-N-15W-24G	ø45mm	2000K-5000K	100cm	15W	750lm	24°	30u.	1u.	78,52 USD
RMS-S-CC-N-15W-36G	ø45mm		100cm	15W	750lm	36°	30u.	1u.	



COLGANTE ESFÉRICO DIFUSO		TEMP.COLOR	LARGO	POTENCIA	LÚMENES	ÁNGULO	MASTER	VENTA MIN.	PRECIO SIN IVA
RMS-S-CED-N-10W	ø100mm	2000K-5000K	100cm	10W	700lm	120°	20u.	1u.	109,35 USD



APLIQUE ESFÉRICO DIFUSO		TEMP.COLOR	LARGO	POTENCIA	LÚMENES	ÁNGULO	MASTER	VENTA MIN.	PRECIO SIN IVA
RMS-S-AED-N-10W	ø100mm	2000K-5000K	11cm	10W	700lm	120°	20u.	1u.	109,35 USD



COLGANTE ESFÉRICO FOCAL		TEMP.COLOR	LARGO	POTENCIA	LÚMENES	ÁNGULO	MASTER	VENTA MIN.	PRECIO SIN IVA
RMS-S-CEF-N-12W	ø100mm	2000K-5000K	100cm	12W	780lm	24°	20u.	1u.	88,46 USD



APLIQUE ESFÉRICO FOCAL		TEMP.COLOR	LARGO	POTENCIA	LÚMENES	ÁNGULO	MASTER	VENTA MIN.	PRECIO SIN IVA
RMS-S-AEF-N-12W-24G	ø100mm	2000K-5000K	11cm	12W	780lm	24°	20u.	1u.	88,46 USD

IVA 21%

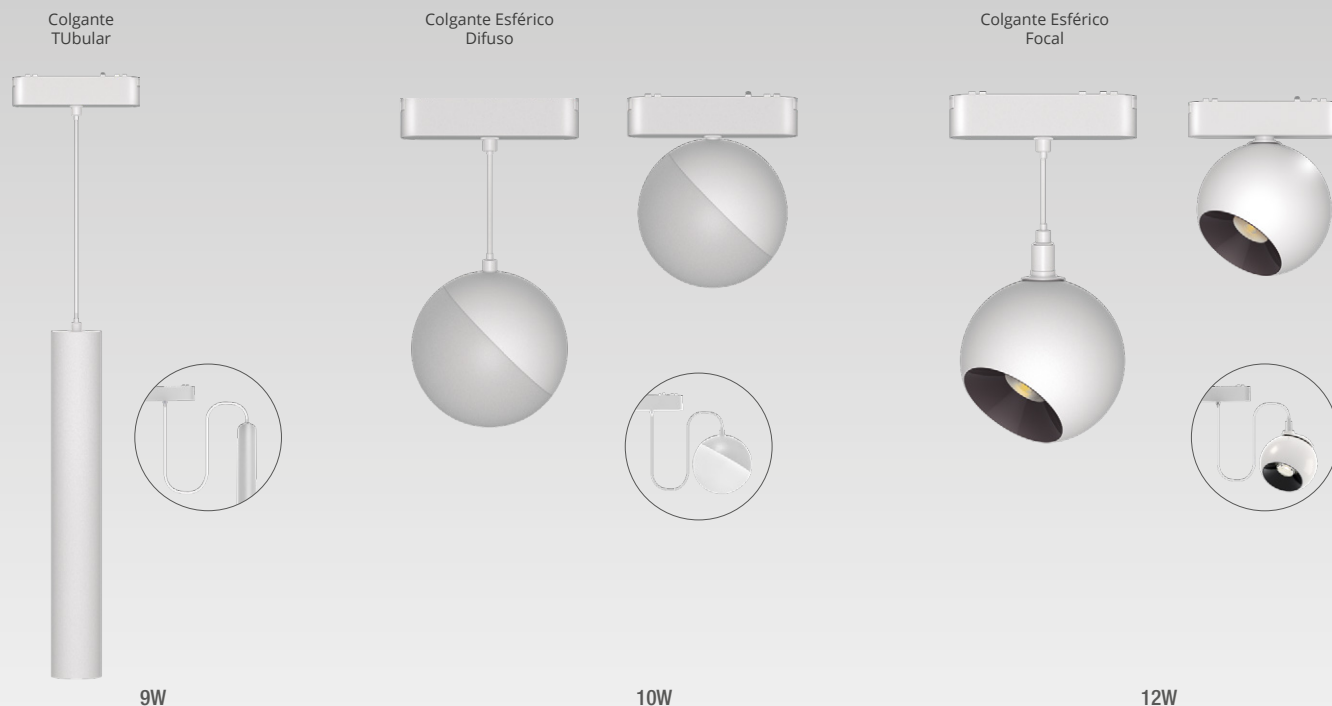

COLGANTE TUBULAR	TEMP.COLOR	LARGO	POTENCIA	LÚMENES	ÁNGULO	MASTER	VENTA MIN.	PRECIO SIN IVA
RMS-CC-B-9W-24G-WW	Blanco Cálido 2700K	100cm	9W	450lm	24°	20u.	1u.	41,37 USD
RMS-CC-B-9W-36G-WW		100cm	9W	450lm	36°	20u.	1u.	41,37 USD
RMS-CC-B-15W-15G-WW		100cm	15W	750lm	15°	30u.	1u.	48,85 USD
RMS-CC-B-15W-24G-WW		100cm	15W	750lm	24°	30u.	1u.	48,85 USD
RMS-CC-B-15W-36G-WW		100cm	15W	750lm	36°	30u.	1u.	48,85 USD

COLGANTE ESFÉRICO DIFUSO	TEMP.COLOR	LARGO	POTENCIA	LÚMENES	ÁNGULO	MASTER	VENTA MIN.	PRECIO SIN IVA
RMS-CED-B-10W-WW	Cálido 2700K	100cm	10W	700lm	120°	20u.	1u.	75,62 USD

APLIQUE ESFÉRICO DIFUSO	TEMP.COLOR	LARGO	POTENCIA	LÚMENES	ÁNGULO	MASTER	VENTA MIN.	PRECIO SIN IVA
RMS-AED-B-10W-WW	Cálido 2700K	11cm	10W	700lm	120°	20u.	1u.	75,62 USD

APLIQUE ESFÉRICO FOCAL	TEMP.COLOR	LARGO	POTENCIA	LÚMENES	ÁNGULO	MASTER	VENTA MIN.	PRECIO SIN IVA
RMS-CEF-B-12W-WW	Cálido 2700K	100cm	12W	780lm	24°	20u.	1u.	58,97 USD

APLIQUE ESFÉRICO FOCAL	TEMP.COLOR	LARGO	POTENCIA	LÚMENES	ÁNGULO	MASTER	VENTA MIN.	PRECIO SIN IVA
RMS-AEF-B-12W-24G-WW	Blanco Cálido 2700K	11cm	12W	780lm	24°	20u.	1u.	58,97 USD
RMS-AEF-B-12W-36G-WW		11cm	12W	780lm	24°	20u.	1u.	58,97 USD

IVA 21%

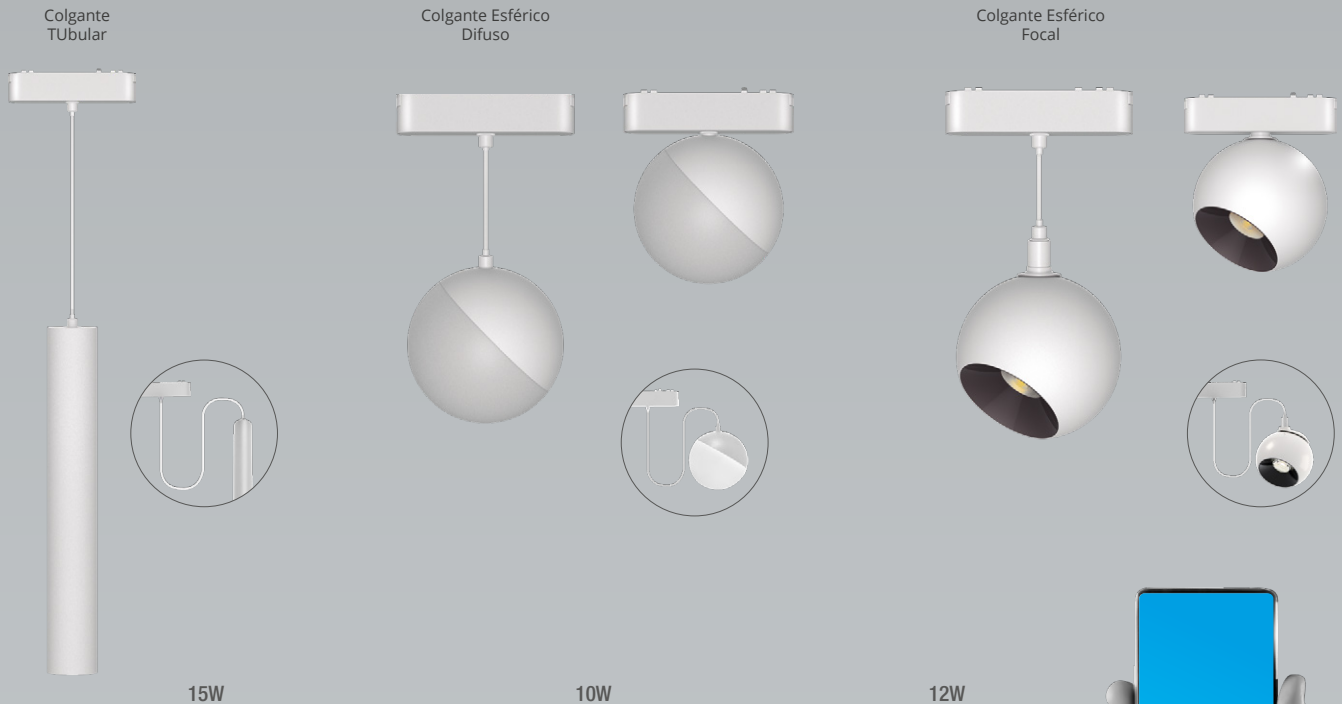

COLGANTE TUBULAR		TEMP.COLOR	LARGO	POTENCIA	LÚMENES	ÁNGULO	MASTER	VENTA MIN.	PRECIO SIN IVA
RMS-S-CC-B-15W-24G	ø45mm	2000K-5000K	100cm	15W	750lm	24°	30u.	1u.	78,52 USD
RMS-S-CC-B-15W-36G	ø45mm	2000K-5000K	100cm	15W	750lm	36°	30u.	1u.	
COLGANTE ESFÉRICO DIFUSO		TEMP.COLOR	LARGO	POTENCIA	LÚMENES	MASTER	VENTA MIN.	PRECIO SIN IVA	
RMS-S-CED-B-10W	ø100mm	2000K-5000K	100cm	10W	700lm	20u.	1u.	109,35 USD	
APLIQUE ESFÉRICO DIFUSO		TEMP.COLOR	LARGO	POTENCIA	LÚMENES	MASTER	VENTA MIN.	PRECIO SIN IVA	
RMS-S-AED-B-10W	ø100mm	2000K-5000K	11cm	10W	700lm	20u.	1u.	109,35 USD	
COLGANTE ESFÉRICO FOCAL		TEMP.COLOR	LARGO	POTENCIA	LÚMENES	MASTER	VENTA MIN.	PRECIO SIN IVA	
RMS-S-CEF-B-12W	ø100mm	2000K-5000K	100cm	12W	780lm	20u.	1u.	88,46 USD	
APLIQUE ESFÉRICO FOCAL		TEMP.COLOR	LARGO	POTENCIA	LÚMENES	MASTER	VENTA MIN.	PRECIO SIN IVA	
RMS-S-AEF-B-12W-24G	ø100mm	2000K-5000K	11cm	12W	780lm	20u.	1u.	88,46 USD	

IVA 21%

APLIQUE TUBO DIFUSO
30cm



Colgante
Tubo flexible



APLIQUE TUBO DIFUSO
60cm

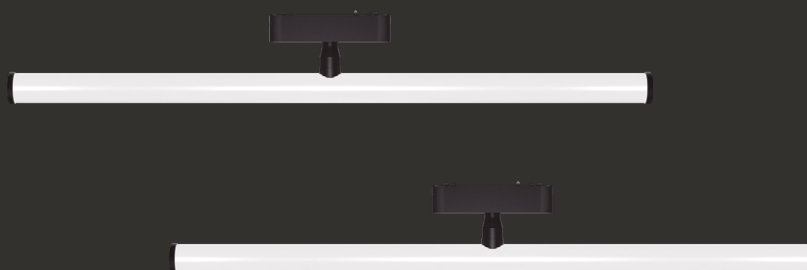

APLIQUE TUBO DIFUSO / NEGRO		TEMP.COLOR	LARGO	POTENCIA	LÚMENES	MASTER	VENTA MIN.	PRECIO SIN IVA
RMS-ATD302-N-6W-WW	ø28mm	Blanco	30cm	6W	600lm	20u.	1u.	32,51 USD
RMS-ATD602-N-12W-WW	ø28mm	Cálido 2700K	60cm	12W	1500lm	20u.	1u.	41,71 USD

APLIQUE TUBO DIFUSO / BLANCO		TEMP.COLOR	LARGO	POTENCIA	LÚMENES	MASTER	VENTA MIN.	PRECIO SIN IVA
RMS-ATD302-B-6W-WW	ø28mm	Blanco	30cm	6W	600lm	20u.	1u.	32,51 USD
RMS-ATD602-B-12W-WW	ø28mm	Cálido 2700K	60cm	12W	1500lm	20u.	1u.	41,71 USD

TUBO FLEXIBLE DIFUSO / NEGRO		TEMP.COLOR	LARGO	POTENCIA	LÚMENES	MASTER	VENTA MIN.	PRECIO SIN IVA
RMS-TF1000-N-10W-WW	ø22mm	Blanco	100cm	10W	600lm	10u.	1u.	60,42 USD
RMS-TF2000-N-20W-WW	ø22mm	Cálido 2700K	200cm	20W	1500lm	10u.	1u.	86,99 USD

TUBO FLEXIBLE DIFUSO / BLANCO		TEMP.COLOR	LARGO	POTENCIA	LÚMENES	MASTER	VENTA MIN.	PRECIO SIN IVA
RMS-TF1000-B-10W-WW	ø22mm	Blanco	100cm	10W	600lm	10u.	1u.	60,42 USD
RMS-TF2000-B-20W-WW	ø22mm	Cálido 2700K	200cm	20W	1500lm	10u.	1u.	86,99 USD

IVA 21%

Fuente de Alimentación

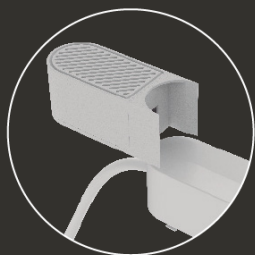

Incluyen endcaps cubrecable



50W-48V

100W-48V

200W-48V

FUENTE DE ALIMENTACIÓN	COLOR	MEDIDAS	POTENCIA	CORRIENTE	DIMERIZABLE	MASTER	VENTA MIN.	PRECIO SIN IVA
FRMS-50W-48V-NEG	● Negro	245x25x28mm	50W	1.05A	No	50u.	50u.	34,80 USD
FRMS-50W-48V-BCO	○ Blanco	245x25x28mm	50W	1.05A	No	50u.	50u.	34,80 USD
FRMS-100W-48V-NEG	● Negro	290x25x27mm	100W	2.1A	No	50u.	50u.	37,53 USD
FRMS-100W-48V-BCO	○ Blanco	290x25x27mm	100W	2.1A	No	50u.	50u.	37,53 USD
FRMS-200W-48V-NEG	● Negro	340x25x27mm	200W	4.2A	No	50u.	50u.	52,41 USD
FRMS-200W-48V-BCO	○ Blanco	340x25x27mm	200W	4.2A	No	50u.	50u.	52,41 USD
FRMS-DIM-100W-48V-NEG	● Negro	290x25x27mm	100W	2.1A	Si	50u.	50u.	71,46 USD
FRMS-DIM-100W-48V-BCO	○ Blanco	290x25x27mm	100W	2.1A	Si	50u.	50u.	71,46 USD
FRMS-DIM-200W-48V-NEG	● Negro	340x25x27mm	200W	4.2A	Si	50u.	50u.	84,18 USD
FRMS-DIM-200W-48V-BCO	○ Blanco	340x25x27mm	200W	4.2A	Si	50u.	50u.	84,18 USD

IVA 21%

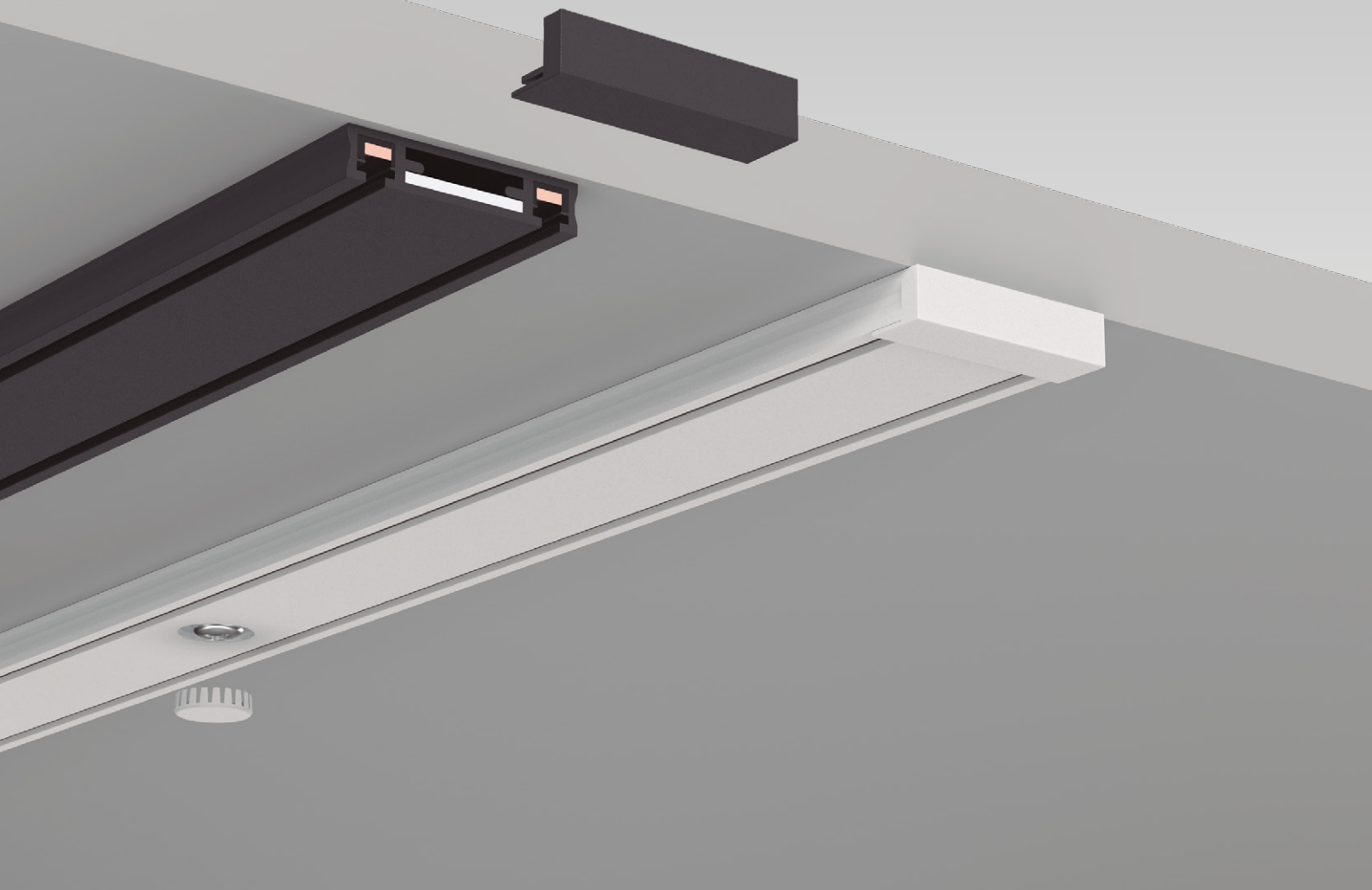

RIELES SLIM	COLOR	METROS	DESCRIPCIÓN	MASTER	INTERMEDIA	VENTA MIN.	PRECIO SIN IVA
RMS-1M-B	● Blanco	1	Riel Magnético Skyline Macroled, DC48V C/ Endcap	40u.	4u.	4u.	9,84 USD
RMS-1M-N	● Negro			40u.	4u.	4u.	
RMS-2M-BCO	● Blanco	2	Riel Magnético Skyline Macroled, DC48V C/ Endcap	40u.	4u.	4u.	19,66 USD
RMS-2M-NEG	● Negro			40u.	4u.	4u.	
RMS-3M-BCO	● Blanco	3	Riel Magnético Skyline Macroled, DC48V C/ Endcap	40u.	4u.	4u.	29,41 USD
RMS-3M-NEG	● Negro			40u.	4u.	4u.	

ACCESORIOS	COLOR	DESCRIPCIÓN	MASTER	INTERMEDIA	VENTA MIN.	PRECIO SIN IVA
RMS-CLR-B	● Blanco	 L Recto	100u.	20u.	2u.	5,82 USD
RMS-CLR-N	● Negro	 L Recto	100u.	20u.	2u.	
RMS-CLC-B	● Blanco	 L Curvo	100u.	20u.	2u.	6,41 USD
RMS-CLC-N	● Negro	 L Curvo	100u.	20u.	2u.	
RMS-CT-B	● Blanco	 T Recto	100u.	50u.	2u.	7,81 USD
RMS-CT-N	● Negro	 T Recto	100u.	50u.	2u.	
RMS-CX-B	● Blanco	 X Curvo	100u.	50u.	2u.	9,87 USD
RMS-CX-N	● Negro	 X Curvo	100u.	50u.	2u.	
RMS-CLV-B	● Blanco	 L Vertical	100u.	20u.	2u.	6,25 USD
RMS-CLV-N	● Negro	 L Vertical	100u.	20u.	2u.	
RMS-CPR-B	● Blanco	 Prolongador Recto	200u.	20u.	4u.	3,51 USD
RMS-CPR-N	● Negro	 Prolongador Recto	200u.	20u.	4u.	

IVA 21%

Riel Embutir

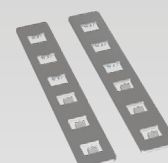
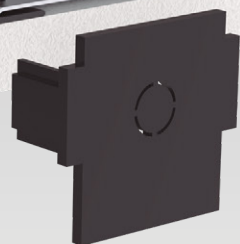
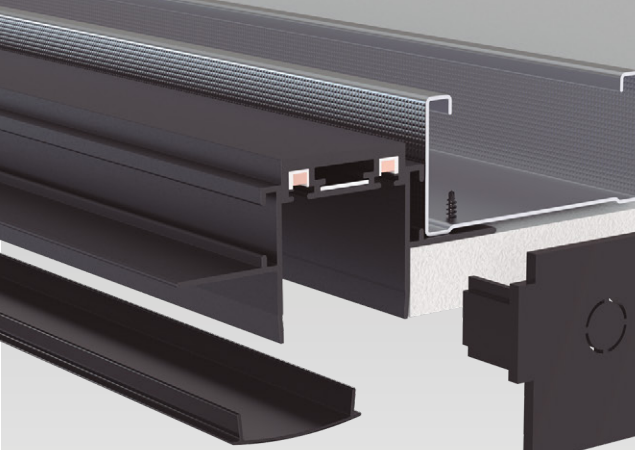

Acoplador de rieles

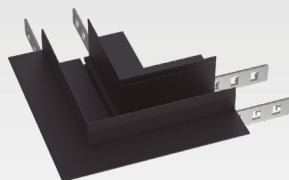

Acople Físico
L

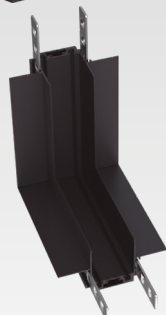

Acople Físico
L vertical

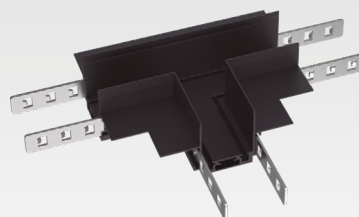

Acople Físico
T

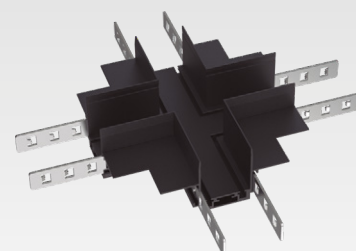

Acople Físico
X



Conductor Eléctrico
I



Conductor Eléctrico
L







Conductor Eléctrico
T



Conductor Eléctrico
X

RIELES EMBUTIR	DESCRIPCIÓN	MASTER	INTERMEDIA	VENTA MIN.	PRECIO SIN IVA
RMS-E-1M	 Riel de aluminio para embutir Skyline 1m, DC48V	10u.	-	10u.	22,59 USD
RMS-E-2M	Riel de aluminio para embutir Skyline 2m, DC48V	10u.	-	10u.	45,14 USD
RMS-E-3M	Riel de aluminio para embutir Skyline 3m, DC48V	10u.	-	10u.	67,62 USD
RMS-AR-E	 Acoplador de para riel magnético Skyline de embutir	800u.	100u.	1u.	0,96 USD
RMS-CL-E	 Conector tipo L para riel magnético Skyline de embutir	50u.	-	1u.	7,37 USD
RMS-CT-E	 Conector tipo T para riel magnético Skyline de embutir	50u.	-	1u.	11,19 USD
RMS-CX-E	 Conector tipo X para riel magnético Skyline de embutir	50u.	-	1u.	14,85 USD
RMS-CLV-E	 Conector tipo L vertical para riel magnético Skyline de embutir	50u.	-	1u.	6,86 USD

SUSPENDER / EMBUTIR	DESCRIPCIÓN	MASTER	VENTA MIN.	PRECIO SIN IVA
RMS-ELI-E-S	 Extensor de línea tipo I para riel magnético Skyline de embutir o suspensión DC48V	100u.	1u.	6,82 USD
RMS-ETLL-E-S	 Extensor de línea tipo L para riel magnético Skyline de embutir o suspensión DC48V	100u.	1u.	7,44 USD
RMS-ETLT-E-S	 Extensor de línea tipo T para riel magnético Skyline de embutir o suspensión DC48V	100u.	1u.	11,58 USD
RMS-ETLX-E-S	 Extensor de línea tipo X para riel magnético Skyline de embutir o suspensión DC48V	100u.	1u.	15,32 USD

IVA 21%

Rieles Magnéticos de Suspender y Aplicar SKYLINE Bold Riel

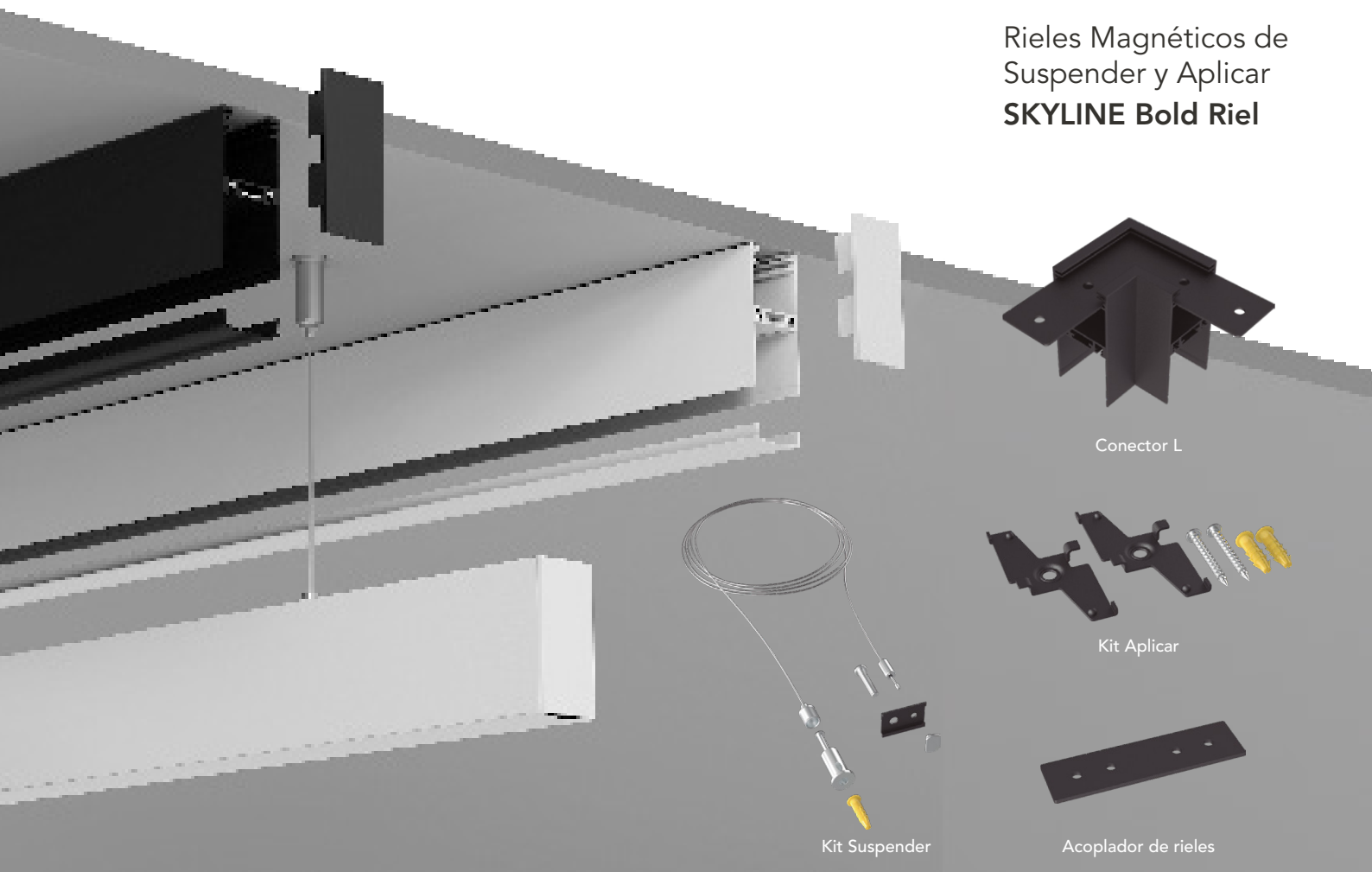

Conector L

Kit Aplicar

Kit Suspender

Acoplador de rieles

RIELES BOLD	DESCRIPCIÓN	MASTER	INTERMEDIA	VENTA MIN.	PRECIO SIN IVA
RMS-S-1M-B	Riel de aluminio Bold Skyline Blanco 1m, DC48V	5u.	-	5u.	31,08 USD
RMS-S-2M-B	Riel de aluminio Bold Skyline Blanco 2m, DC48V	5u.	-	5u.	62,05 USD
RMS-S-3M-B	Riel de aluminio Bold Skyline Blanco 3m, DC48V	5u.	-	5u.	93,07 USD
RMS-S-1M	Riel de aluminio Bold Skyline Negro 1m, DC48V	5u.	-	5u.	31,08 USD
RMS-S-2M	Riel de aluminio Bold Skyline Negro 2m, DC48V	5u.	-	5u.	62,05 USD
RMS-S-3M	Riel de aluminio Bold Skyline Negro 3m, DC48V	5u.	-	5u.	93,07 USD
RMS-AR-S	Acoplador de rieles para riel magnético Bold Skyline	400u.	50u.	1u.	1,93 USD
RMS-CL-S	Conector tipo L para riel magnético Bold Skyline	50u.	-	1u.	7,55 USD
RMS-S-S	Suspendor de rieles para riel magnético Bold Skyline 2x2 metros	100u.	-	Unitaria (x2 u.)	7,01 USD
RMS-A-S	Kit Aplicar para riel magnético Bold Skyline	100u.	-	10u.	3,33 USD
					IVA 21%

BOLD / EMBUTIR	DESCRIPCIÓN	MASTER	INTERMEDIA	VENTA MIN.	PRECIO SIN IVA
RMS-ELI-E-S	Extensor de línea tipo I para riel magnético Bold o embutir Skyline DC48V	100u.	10u.	1u.	7,46 USD
RMS-ETLL-E-S	Extensor de línea tipo L para riel magnético Bold o embutir Skyline DC48V	100u.	10u.	1u.	8,01 USD
RMS-ETLT-E-S	Extensor de línea tipo T para riel magnético Bold o embutir Skyline DC48V	100u.	10u.	1u.	12,37 USD
RMS-ETLX-E-S	Extensor de línea tipo X para riel magnético Bold o embutir Skyline DC48V	100u.	10u.	1u.	16,48 USD
					IVA 21%



PROTECCIÓN UV
Cobertura Anti UV. No se daña el color por la exposición al sol



APTO EXTERIORES
Con Protección IP54 certificado apto para la intemperie y mal clima



MULTIVOLTAJE
Gran versatilidad en su funcionamiento AC100-265V

TORTUGA LED BLANCA REDONDA					MEDIDAS	FP	LM X W	MASTER	VENTA MIN.	PRECIO SIN IVA
TR-MB-12W-WW	12W	Cálido	3000°K	1080lm	140x50mm	0.95	90	40u.	5u.	11,90 USD
TR-MB-12W-CW	12W	Frío	6500°K	1080lm	140x50mm	0.95	90	40u.	5u.	
TR-MB-18W-WW	18W	Cálido	3000°K	1620lm	175x50mm	0.95	90	40u.	5u.	14,90 USD
TR-MB-18W-CW	18W	Frío	6500°K	1680lm	175x50mm	0.95	90	40u.	5u.	

IVA 21%



TORTUGA LED BLANCA OVAL					MEDIDAS	FP	LM X W	MASTER	VENTA MIN.	PRECIO SIN IVA
TO-MB-12W-WW	12W	Cálido	3000°K	1080lm	16x4,7x8,7mm	0.95	90	40u.	5u.	11,25 USD
TO-MB-12W-CW	12W	Frío	6500°K	1080lm	16x4,7x8,7mm	0.95	90	40u.	5u.	
TO-MB-18W-WW	18W	Cálido	3000°K	1620lm	19,5x4,8x9,7mm	0.95	90	40u.	5u.	13,60 USD
TO-MB-18W-CW	18W	Frío	6500°K	1680lm	19,5x4,8x9,7mm	0.95	90	40u.	5u.	

IVA 21%



TORTUGA LED NEGRA REDONDA					MEDIDAS	FP	LM X W	MASTER	VENTA MIN.	PRECIO SIN IVA
TR-MN-12W-WW	12W	Cálido	3000°K	1080lm	140x50mm	0.95	90	40u.	5u.	11,90 USD
TR-MN-12W-CW	12W	Frío	6500°K	1080lm	140x50mm	0.95	90	40u.	5u.	
TR-MN-18W-WW	18W	Cálido	3000°K	1620lm	175x50mm	0.95	90	40u.	5u.	14,90 USD
TR-MN-18W-CW	18W	Frío	6500°K	1680lm	175x50mm	0.95	90	40u.	5u.	

IVA 21%



TORTUGA LED NEGRA OVAL					MEDIDAS	FP	LM X W	MASTER	VENTA MIN.	PRECIO SIN IVA
TO-MN-12W-WW	12W	Cálido	3000°K	1080lm	16x4,7x8,7mm	0.95	90	40u.	5u.	11,25 USD
TO-MN-12W-CW	12W	Frío	6500°K	1080lm	16x4,7x8,7mm	0.95	90	40u.	5u.	
TO-MN-18W-WW	18W	Cálido	3000°K	1620lm	19,5x4,8x9,7mm	0.95	90	40u.	5u.	13,60 USD
TO-MN-18W-CW	18W	Frío	6500°K	1680lm	19,5x4,8x9,7mm	0.95	90	40u.	5u.	

IVA 21%



ESTACA LED 5W / ø56x265 mm					MATERIAL	PROTECCIÓN	MASTER	VENTA MIN	PRECIO SIN IVA
ELP-5W-IP65-WW	Cálido	3000°K	420lm	84lm/W	PP/ Nylon	IP65	60u.	10u.	10,10 USD
ELP-5W-IP65-NW	Neutro	4500°K	420lm	84lm/W	PP/ Nylon	IP65	60u.	10u.	IVA 21%

ESTACA LED 7W / ø75x230 mm					MATERIAL	PROTECCIÓN	MASTER	VENTA MIN	PRECIO SIN IVA
ELAC-7W-IP65-WW	Cálido	3000°K	580lm	84lm/W	Aluminio	IP65	40u.	10u.	19,04 USD
ELAC-7W-IP65-NW	Neutro	4500°K	580lm	84lm/W	Aluminio	IP65	40u.	10u.	IVA 21%

ESTACA GU10 / ø98x322mm		APLIQUE	MATERIAL	PROTECCIÓN	MASTER	VENTA MIN	PRECIO SIN IVA
EDGU10-IP65	35W Máx	Suelo / Pared	Aluminio	IP65/IK07	40u.	10u.	18,67 USD
							IVA 21%

ESTACA / 35x145mm	MEDIDAS	APLIQUE	MATERIAL	MASTER	VENTA MIN.	PRECIO SIN IVA
EA-145MM	35X145 mm	Suelo	Aluminio	200u.	10u.	1,51 USD
						IVA 21%



ESTACA SOLAR X1 2W / 106x165x300 mm					AUTONOMÍA	PROTECCIÓN	MASTER	VENTA MIN.	PRECIO SIN IVA
ELSX1-2W-IP65-WW	Cálido	3000°K	150/250lm	6hs.	IP65	30u.	5u.	27,68 USD	
ELSX1-2W-IP65-CW	Frío	6500°K	150/250lm	6hs.	IP65	30u.	5u.	IVA 21%	

ESTACA SOLAR X2 1W / 152x105x45 mm					AUTONOMÍA	PROTECCIÓN	MASTER	VENTA MIN.	PRECIO SIN IVA
ELSX2-2W-IP65-WW	Cálido	3000°K	300/500lm	12-14hs.	IP65	12u.	-	60,30 USD	
									IVA 21%

ESTACA SOLAR X4 1W / 300x105x48 mm					AUTONOMÍA	PROTECCIÓN	MASTER	VENTA MIN.	PRECIO SIN IVA
ELSX4-4W-IP65-WW	Cálido	3000°K	200/320lm	12-14hs.	IP65	6u.	-	93,06 USD	
									IVA 21%



ASPSM-5W-IP65

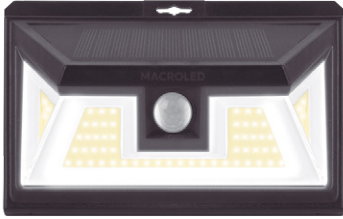

FOTOCÉLULA

El artefacto se enciende en ausencia de la luz ambiente



Batería de Litio
3.7V/2200mAh

ASPSM-10W-IP65

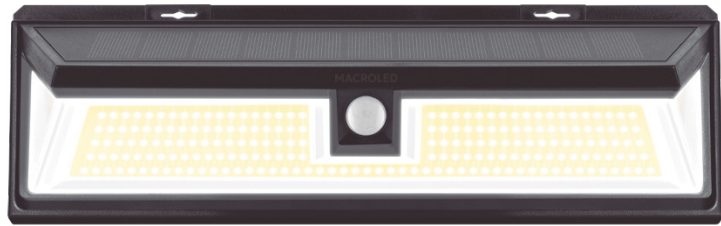

FOTOCÉLULA

El artefacto se enciende en ausencia de la luz ambiente



Baterías de Litio x2
3.7V/2200mAh

ASP-1.5W-IP54



FOTOCÉLULA

El artefacto se enciende en ausencia de la luz ambiente



Batería de Litio
3.7V/1800mAh

1

Se enciende al 100% al detectar movimiento. Se apaga luego de 30 seg. de inactividad.

2

Se enciende al 50% constante, ante la ausencia de luz ambiente y sin función de movimiento.

3

Se enciende al 50%. Al detectar movimiento, pasa al 100% y vuelve al estado anterior luego de 30 seg. de inactividad.

*Aplicable a los modelos ASPSM de 5W y 10W

LUZ DE PARED 1.5W SOLAR / 94x122x48mm			AUTONOMÍA	PROTECCIÓN	MASTER	VENTA MIN.	PRECIO SIN IVA
ASP-1.5W-IP54WW	Cálido	3000°K	50lm	9hs.	IP54	80u.	10u.
ASP-1.5W-IP54CW	Frío	6500°K	50lm	9hs.	IP54	80u.	10u.
							7,45 USD
							IVA 21%

LUZ DE PARED 5W SOLAR / 152x105x45mm			AUTONOMÍA	PROTECCIÓN	MASTER	VENTA MIN.	PRECIO SIN IVA
ASPSM-5W-IP65-WW	Cálido	3000°K	300/500lm	8-10hs.	IP65	48u.	6u.
ASPSM-5W-IP65-CW	Frío	6500°K	300/500lm	8-10hs.	IP65	48u.	6u.
							18,55 USD
							IVA 21%

LUZ DE PARED 10W SOLAR / 300x105x48mm			AUTONOMÍA	PROTECCIÓN	MASTER	VENTA MIN.	PRECIO SIN IVA
ASPSM-10W-IP65-WW	Cálido	3000°K	600/1000lm	8-10hs.	IP65	24u.	6u.
ASPSM-10W-IP65-CW	Frío	6500°K	600/1000lm	8-10hs.	IP65	24u.	6u.
							32,95 USD
							IVA 21%

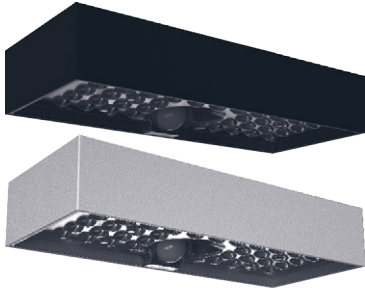

SSLL-6W-N / SSLL-6W-B



Batería de Litio
3.7V/3000mAh



SSFL-5W



Batería de Litio
3.7V/3000mAh



SSFL-10W



Batería de Litio x3
7.4V/3000mAh



SSFLM-10W



Batería de Litio
3.7V/7200mAh



FOTOCÉLULA
El artefacto se enciende en ausencia de la luz ambiente

AHORRO ENERGÉTICO

Producto con batería de litio recargable con energía solar.

ENCENDIDO INSTANTÁNEO

Enciende al 100% de su capacidad lumínica instantáneamente.

SIN RUIDOS NI PARPADEOS

No produce luz intermitente ni ruidos molestos.

PROTECCIÓN IP65

Equipo resistente a salpicaduras de agua y a prueba de polvo.

PRODUCTO ECOLÓGICO

Producto libre de materiales tóxicos. La energía solar no causa contaminación.

DE BAJO MANTENIMIENTO

Apenas se necesita limpiar los paneles con un paño con agua y jabón.

ARTEFACTO DE PARED SOLAR 6W / 230x97x43 mm				AUTONOMÍA	PROTECCIÓN	MASTER	VENTA MIN.	PRECIO SIN IVA
SSLL-6W-B-WW	Cálido	3000°K	800lm	2 a 4 noches (20-40hs) según el modo (baja/alta)	IP65	24u.	24u.	18,00 USD
SSLL-6W-N-WW	Cálido	3000°K	800lm		IP65	24u.	24u.	18,00 USD
BATERIA REPUESTO		COMPATIBILIDAD		AUTONOMÍA	MASTER	VENTA MIN.	PRECIO SIN IVA	
SSLL-6W-BAT	SSLL-6W-B-WW / SSLL-6W-N-WW		2 a 4 noches (20-40hs según el modo (baja/alta))		160u.	1u.	6,00 USD	IVA 21%

REFLECTOR SOLAR 5W / 240x162x40mm				AUTONOMÍA	PROTECCIÓN	MASTER	VENTA MIN.	PRECIO SIN IVA
SSFL-5W-WW	Cálido	3000°K	500lm	1 noche (luz constante) a 5 noches (con sensor)	IP65	18u.	18u.	34,74 USD
SSFL-5W-CW	Frío	6000°K	500lm		IP65	18u.	18u.	
BATERIA REPUESTO		COMPATIBILIDAD		AUTONOMÍA	MASTER	VENTA MIN.	PRECIO SIN IVA	
SSFL-5W-BAT	SSFL-5W-B-WW / SSFL-5W-N-CW		1 noche (luz constante) a 5 noches (con sensor)		160u.	1u.	19,60 USD	IVA 21%

REFLECTOR SOLAR 10W / 560x340x245mm				AUTONOMÍA	PROTECCIÓN	MASTER	VENTA MIN.	PRECIO SIN IVA
SSFL-10W-WW	Cálido	3000°K	1150lm	6-50hs.	IP65	8u.	8u.	74,86 USD
SSFL-10W-CW	Frío	6000°K	1150lm	6-50hs.	IP65	8u.	8u.	
BATERIA REPUESTO		COMPATIBILIDAD		AUTONOMÍA	MASTER	VENTA MIN.	PRECIO SIN IVA	
SSFL-10W-BAT	SSFL-10W-B-WW / SSFL-10W-N-CW		6-50hs		80u.	1u.	6,05 USD	IVA 21%

REFLECTOR SOLAR 10 W / 345x236x25 mm				AUTONOMÍA	PROTECCIÓN	MASTER	VENTA MIN.	PRECIO SIN IVA
SSFLM-10W-WW	Cálido	3000°K	1100lm	6-30hs.	IP65	10u.	10u.	50,00 USD
SSFLM-10W-CW	Frío	6000°K	1100lm	6-30hs.	IP65	10u.	10u.	116,87 USD
BATERIA REPUESTO		COMPATIBILIDAD		AUTONOMÍA	MASTER	VENTA MIN.	PRECIO SIN IVA	
SSFLM-10W-BAT	SSFLM-10W-WW / SSFLM-10W-CW		6-30hs		80u.	1u.	19,66 USD	IVA 21%



SSSL-40W-CW



Tiempo de Carga
8-10hs



Batería de Litio
12.8V/6000mAh



Fotocélula
El artefacto se enciende en ausencia de luz ambiente

PRODUCTO ECOLÓGICO
Producto libre de materiales tóxicos. La energía solar no causa contaminación.

AHORRO ENERGÉTICO
Producto con batería de litio recargable con energía solar.

ENCENDIDO INSTANTÁNEO
Enciende al 100% de su capacidad luminica instantáneamente.

SIN RUIDOS NI PARPADEOS
No produce luz intermitente ni ruidos molestos.

PROTECCION IP65
Equipo resistente a salpicaduras de agua y a prueba de polvo.

DE BAJO MANTENIMIENTO
Apenas se necesita limpiar los paneles con un paño con agua y jabón.

LUZ DE CALLE SOLAR / 706x290x74 mm				AUTONOMÍA	PROTECCIÓN	MASTER	VENTA MIN.	PRECIO SIN IVA
SSSL-40W-CW	Frío	6000°K	4800lm	6-30hs (1-3 noches)	IP65	4u.	4u.	285,98 USD
BATERIA REPUESTO		COMPATIBILIDAD		AUTONOMÍA		MASTER	VENTA MIN.	PRECIO SIN IVA
SSSL-40W-BAT	SSSL-40W-CW		6 a 30 horas (1 a 3 noches)			24u.	1u.	81,00 USD
								IVA 21%



Batería de Litio
7.4V/5400mAh

BATERIA REPUESTO		COMPATIBILIDAD		AUTONOMÍA		MASTER	VENTA MIN.	PRECIO SIN IVA
SSSL-15W-BAT	SSSL-15W-CW		6 a 50 horas (1 a 5 noches)			48u.	1u.	29,50 USD
								IVA 21%



Eficiencia lumínica de 90lm/W



Válvula Anti-Humedad



Fácil Colocación



Protección SPD
10W/20W: 1kV
30W/50W: 2kV



Apto para la interperie y el mal clima



REFLECTOR 10W / IP65 / AC100-240V / 95° / 125x104x27mm					VIDA ÚTIL	MASTER	PRECIO SIN IVA
FLSV2-10WW	Cálido	3000°K	900lm	90 lm/W	50.000hs	20u.	11,20 USD IVA 21%
FLSV2-10CW	Frío	6500°K	900lm	90 lm/W	50.000hs	20u.	



REFLECTOR 20W / IP65 / AC100-240V / 95° / 152x125x28mm					VIDA ÚTIL	MASTER	PRECIO SIN IVA
FLSV2-20WW	Cálido	3000°K	1800lm	90 lm/W	50.000hs	20u.	16,20 USD IVA 21%
FLSV2-20CW	Frío	6500°K	1800lm	90 lm/W	50.000hs	20u.	



REFLECTOR 30W / IP65 / AC100-240V / 95° / 168x209x30mm					VIDA ÚTIL	MASTER	PRECIO SIN IVA
FLSV2-30WW	Cálido	3000°K	2700lm	90 lm/W	50.000hs	20u.	26,08 USD IVA 21%
FLSV2-30CW	Frío	6500°K	2700lm	90 lm/W	50.000hs	20u.	



REFLECTOR BLANCO 30W / IP65 / AC100-240V / 95° / 168x209x30mm					VIDA ÚTIL	MASTER	PRECIO SIN IVA
BFLSV2-30WW	Cálido	3000°K	2700lm	90 lm/W	50.000hs	20u.	24,54 USD IVA 21%
BFLSV2-30CW	Frío	6500°K	2700lm	90 lm/W	50.000hs	20u.	



REFLECTOR NEGRO 30W / IP65 / AC100-240V / 95° / 168x209x30mm					VIDA ÚTIL	MASTER	PRECIO SIN IVA
FLSV2-50WW	Cálido	3000°K	4500lm	90 lm/W	50.000hs	12u.	36,40 USD IVA 21%
FLSV2-50CW	Frío	6500°K	4500lm	90 lm/W	50.000hs	12u.	



REFLECTOR BLANCO 50W / IP65 / AC100-240V / 95° / 200x237x36mm					VIDA ÚTIL	MASTER	PRECIO SIN IVA
BFLSV2-50WW	Cálido	3000°K	4500lm	90 lm/W	50.000hs	12u.	36,40 USD IVA 21%
BFLSV2-50CW	Frío	6500°K	4500lm	90 lm/W	50.000hs	12u.	



Eficiencia lumínica de 110lm/W



Válvula Anti-Humedad



Fácil Colocación



Protección SPD 2kV



Apto para la interperie y el mal clima



REFLECTOR 100W / IP65 / AC100-240V / 95° / 343x302x45mm					VIDA ÚTIL	MASTER	PRECIO SIN IVA
FLSV2-100WW	Cálido	3000°K	11.000lm	110 lm/W	50.000hs	4u.	60,00 USD IVA 21%
FLSV2-100CW	Frío	6500°K	11.000lm	110 lm/W	50.000hs	4u.	



REFLECTOR 150W / IP65 / AC100-240V / 95° / 443x351x58mm					VIDA ÚTIL	MASTER	PRECIO SIN IVA
FLSV2-150WW	Cálido	3000°K	16.500lm	110 lm/W	50.000hs	2u.	115,00 USD IVA 21%
FLSV2-150CW	Frío	6500°K	16.500lm	110 lm/W	50.000hs	2u.	



REFLECTOR 200W / IP65 / AC100-240V / 95° / 493x400x58mm					VIDA ÚTIL	MASTER	PRECIO SIN IVA
FLSV2-200WW	Cálido	3000°K	22.000lm	110 lm/W	50.000hs	2u.	130,00 USD IVA 21%
FLSV2-200CW	Frío	6500°K	22.000lm	110 lm/W	50.000hs	2u.	



REFLECTOR 400W / IP65 / AC100-240V / 95° / 599x442x62mm					VIDA ÚTIL	MASTER	PRECIO SIN IVA
FLSV2-400CW	Frío	6500°K	52.000lm	130 lm/W	50.000hs	1u.	317,00 USD IVA 21%



C Sensor de luz
(Modo de operación: día o noche)

B Timer de encendido
(Tiempo de encendido de 10 segundos a 10 minutos)

A Sensor de movimiento
(Sensor de sensibilidad ajustable)

Protección SPD
20W: 1kV
30W/50W: 2kV

IK08
IP65
Apto para la interperie y el mal clima



REFLECTOR 20W / IP65 / AC100-240V / 95° / 159x125x55mm					VIDA ÚTIL	MASTER	PRECIO SIN IVA
SFLSV2-20WW	Cálido	3000°K	1800lm	90 lm/W	50.000hs	10u.	34,00 USD
							IVA 21%



REFLECTOR 30W / IP65 / AC100-240V / 95° / 168x252x54mm					VIDA ÚTIL	MASTER	PRECIO SIN IVA
SFLSV2-30WW	Cálido	3000°K	2700lm	90 lm/W	50.000hs	10u.	43,36 USD
							IVA 21%



REFLECTOR 50W / IP65 / AC100-240V / 95° / 200x237x57mm					VIDA ÚTIL	MASTER	PRECIO SIN IVA
SFLSV2-50WW	Cálido	3000°K	4500lm	90 lm/W	50.000hs	6u.	54,72 USD
SFLSV2-50CW	Frío	6500°K	4500lm	90 lm/W	50.000hs	6u.	
							IVA 21%



IP65/IK05
Protección Superior



Protección SPD
500V



Mayor Eficacia
Factor de Potencia
Superior 0.5



Válvula
NUEVO: Válvula de humedad en
modelos de 20 a 200



SAMSUNG LED
Con chip Samsung, marca
líder en el mercado



25.000hs
Vida útil extendida



Brazo 45°
Diseñado para su fácil y
rápida colocación.



REFLECTOR 10W / IP65 / AC220-240V / 110° / 105x70x25 mm					VIDA ÚTIL	MASTER	PRECIO SIN IVA
EFL-10W-WW	Cálido	3000°K	800lm	80lm/W	25.000hs	60u.	5,54 USD IVA 21%
EFL-10W-CW	Frío	6500°K	800lm	80lm/W	25.000hs	60u.	



REFLECTOR 20W / IP65 / AC220-240V / 110° / 152x125x28mm					VIDA ÚTIL	MASTER	PRECIO SIN IVA
EFL-20W-WW	Cálido	3000°K	1.600lm	80lm/W	25.000hs	50u.	7,50 USD IVA 21%
EFL-20W-CW	Frío	6500°K	1.600lm	80lm/W	25.000hs	50u.	



REFLECTOR 30W / IP65 / AC120-265V / 120° / 110x85x28mm					VIDA ÚTIL	MASTER	PRECIO SIN IVA
EFLG2-30W-WW	Cálido	3000°K	3.300lm	110lm/W	30.000hs	30u.	10,90 USD IVA 21%



REFLECTOR 30W / IP65 / AC220-240V / 110° / 168x209x30mm					VIDA ÚTIL	MASTER	PRECIO SIN IVA
EFL-30W-CW	Frío	6500°K	2.400lm	80lm/W	25.000hs	30u.	10,91 USD IVA 21%



REFLECTOR 50W / IP65 / AC120-265V / 120° / 179x138x31mm					VIDA ÚTIL	MASTER	PRECIO SIN IVA
EFLG2-50W-WW	Cálido	3000°K	5.500lm	110lm/W	30.000hs	20u.	13,90 USD IVA 21%



REFLECTOR 50W / IP65 / AC220-240V / 110° / 200x237x36mm					VIDA ÚTIL	MASTER	PRECIO SIN IVA
EFL-50W-CW	Frío	6500°K	4.000lm	80lm/W	25.000hs	30u.	13,84 USD IVA 21%



IP65/IK05
Protección Superior



Protección SPD
500V



Mayor Eficacia
Factor de Potencia Superior 0.9



Válvula
NUEVO: Válvula de humedad en modelos de 20 a 200



SAMSUNG LED
Con chip Samsung, marca líder en el mercado



25.000hs
Vida útil extendida



Brazo 45°
Diseñado para su fácil y rápida colocación.



REFLECTOR 100W / IP65 / AC100-240V / 110° / 245x180x36 mm					VIDA ÚTIL	MASTER	PRECIO SIN IVA
EFL-100W-WW	Cálido	3000°K	9.000lm	90 lm/W	25.000hs	5u.	30,28 USD
EFL-100W-CW	Frío	6500°K	9.000lm	90 lm/W	25.000hs	5u.	IVA 21%



REFLECTOR 150W / IP65 / AC100-240V / 110° / 375x280x38mm					VIDA ÚTIL	MASTER	PRECIO SIN IVA
EFL-150W-WW	Cálido	3000°K	13.500lm	90 lm/W	25.000hs	5u.	49,05 USD
							IVA 21%



REFLECTOR 150W / IP65 / AC120-265V / 120° / 238x205x39mm					VIDA ÚTIL	MASTER	PRECIO SIN IVA
EFLG2-150W-CW	Frío	6500°K	16.500lm	110 lm/W	30.000hs	10u.	49,00 USD
							IVA 21%



REFLECTOR 200W / IP65 / AC100-240V / 110° / 410x298x40mm					VIDA ÚTIL	MASTER	PRECIO SIN IVA
EFL-200W-WW	Cálido	3000°K	18.000lm	90 lm/W	25.000hs	4u.	63,30 USD
							IVA 21%



REFLECTOR 200W / IP65 / AC120-265V / 120° / 272x233x42mm					VIDA ÚTIL	MASTER	PRECIO SIN IVA
EFLG2-200W-CW	Frío	6500°K	22.000lm	110 lm/W	30.000hs	10u.	63,30 USD
							IVA 21%



IP65/IK05
Protección Superior



Protección SPD
4kV



Mayor Eficacia
Factor de Potencia Superior 0.9



SAMSUNG LED
Con chip Samsung, marca líder en el mercado



30.000hs
Vida útil extendida



Brazo 45°
Diseñado para su fácil y rápida colocación.



REFLECTOR 300W / IP65 / AC100-240V / 110° / 538x379x48mm					VIDA ÚTIL	VENTA MÍN.	MASTER	PRECIO SIN IVA
EFL-300W-WW	Cálido	3000°K	30.000lm	100lm/W	25.000hs	1u.	4u.	120,00 USD IVA 21%
EFL-300W-CW	Frío	6500°K	30.000lm	100lm/W	25.000hs	1u.	4u.	



300W - 60°



400W - 60°



600W - 30° / 600W - 60°



800W - 60°



1000W - 60°



IP66/IK08
Protección Superior



ANTIHIGHVOLT
Protección contra
sobre-tensiones de 1500V



Mayor Eficacia
Factor de Potencia
Superior 0.9



50.000hs
Vida útil extendida



140lm/Watt
Eficacia lumínica
Mejorada



DRIVER
Sosen



Ángulo de
apertura
Reducido con Julior precisión

REFLECTORES TITAN	POTENCIA	TENSIÓN	TEMPERATURA		MEDIDAS	LÚMENES	VIDA ÚTIL	MÁSTER	PRECIO SIN IVA
FLSP-300-60G-CW	300W	AC100-277V	Frío	5700°K	522x370x152mm	140 lm/W	50.000hs	1u.	614,00 USD
FLSP-400-60G-CW	400W	AC100-277V	Frío	5700°K	522x466x152mm	140 lm/W	50.000hs	1u.	763,50 USD
FLSP-600-30G-CW	600W	AC100-277V	Frío	5700°K	575x700x152mm	140 lm/W	50.000hs	1u.	1.040,00 USD
FLSP-600-60G-CW	600W	AC100-277V	Frío	5700°K	575x700x152mm	140 lm/W	50.000hs	1u.	1.050,00 USD
FLSP-800-60G-CW	800W	AC100-277V	Frío	5700°K	974x612x177mm	140 lm/W	50.000hs	1u.	1.560,00 USD
FLSP-1000-60G-CW	1000W	AC100-277V	Frío	5700°K	974x707x177mm	140 lm/W	50.000hs	1u.	1.898,00 USD

IVA 21%



500W - 60°



1000W - 60°



SPD 6KV
Gran protección
contra sobretensiones



120lm/W
Eficiencia Lumínica
Superior



THD < 15%
Driver premium con
Reducción de interferencias



IK08
IP65
IP65/IK08
Protección Superior



REFLECTORES OLIMPUS	POTENCIA	TENSIÓN	TEMPERATURA		MEDIDAS	LÚMENES	VIDA ÚTIL	MÁSTER	PRECIO SIN IVA
OLIMPUS-500W-60G-CW	500W	AC100-277V	Frío	6500°K	530x65x523mm	60000lm	50.000hs	1u.	448,98 USD
OLIMPUS-1000W-60G-CW	1000W	AC100-277V	Frío	6500°K	1022x65x525mm	120000lm	50.000hs	1u.	898,23 USD
									IVA 21%

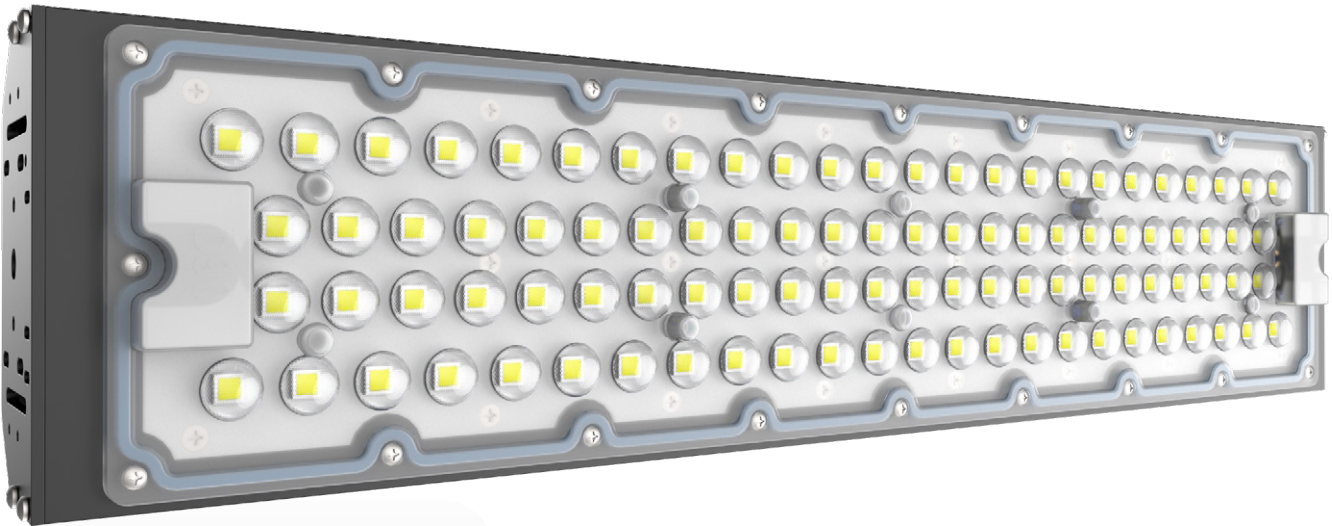

Protector SPD 10KV absorbe picos de hasta 10.000 voltios



IP66/IK08 Protección Superior



Ángulos de aperturas



ANTIHIGHVOLT Protección contra sobretensiones de 1500V



Mayor Eficacia Factor de Potencia Superior 0.95



Cuerpo de Aluminio



170lm/Watt Eficiencia lumínica Mejorada



100.000hs Vida útil extendida

REFLECTORES FOCUS	APERTURA	TENSIÓN	TEMPERATURA	MEDIDAS	LÚMENES	VIDA ÚTIL	MASTER	PRECIO SIN IVA
FOCUS-250W-20G-CW	20°	250W AC100-240V	Frío 5700°K	550x122x127mm	42.500lm	100.000hs	4u.	363,80 USD
FOCUS-250W-40G-CW	40°	250W AC100-240V	Frío 5700°K	550x122x127mm	42.500lm	100.000hs	4u.	
FOCUS-250W-60G-CW	60°	250W AC100-240V	Frío 5700°K	550x122x127mm	42.500lm	100.000hs	4u.	
FOCUS-250W-90G-CW	90°	250W AC100-240V	Frío 5700°K	550x122x127mm	42.500lm	100.000hs	4u.	
FOCUS-250W-ASIM-CW	ASIMÉTRICO	250W AC100-240V	Frío 5700°K	550x122x127mm	42.500lm	100.000hs	4u.	
								IVA 21%

 **CONECTOR INCLUIDO**
Para una instalación más rápida y segura.

 **Cuerpo de aluminio**
Garantiza durabilidad ante condiciones adversas.

 **5 años de garantía**

(*) Todos los brazos incluyen **Protector SPD 20KV**
Absorbe picos de hasta 20.000 voltios

X1 FOCUS-BR-250W

42.500lm

X2 FOCUS-BR-500W

85.000lm

X3 FOCUS-BR-750W

127.500lm

X4 FOCUS-BR-1000W

170.000lm

FOCUS-VAE

FOCUS-L-500M

REFLECTORES FOCUS	DESCRIPCIÓN	CAJA MÁSTER	PRECIO SIN IVA
FOCUS-BR-250W	Soporta 1 módulo de cualquier ángulo de apertura.	24u.	33,48 USD
FOCUS-BR-500W	Soporta 2 módulos de cualquier ángulo de apertura.	6u.	98,99 USD
FOCUS-BR-750W	Soporta 3 módulos de cualquier ángulo de apertura.	6u.	159,99 USD
FOCUS-BR-1000W	Soporta 4 módulos de cualquier ángulo de apertura.	6u.	218,15 USD
FOCUS-VAE	-	24u.	21,13 USD
FOCUS-L-500M	Alcance de 500 mts. máximo. Batería de litio 16340.	200u.	22,35 USD
			IVA 21%

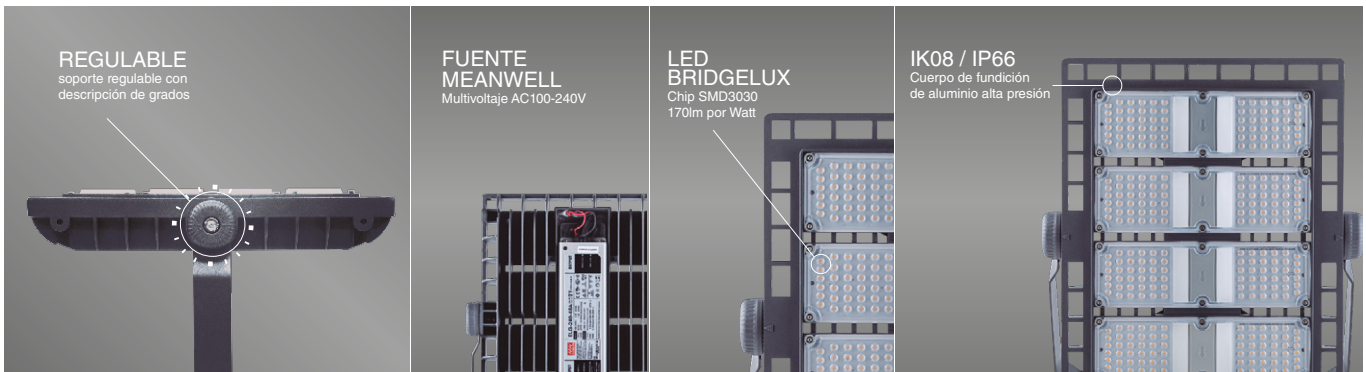
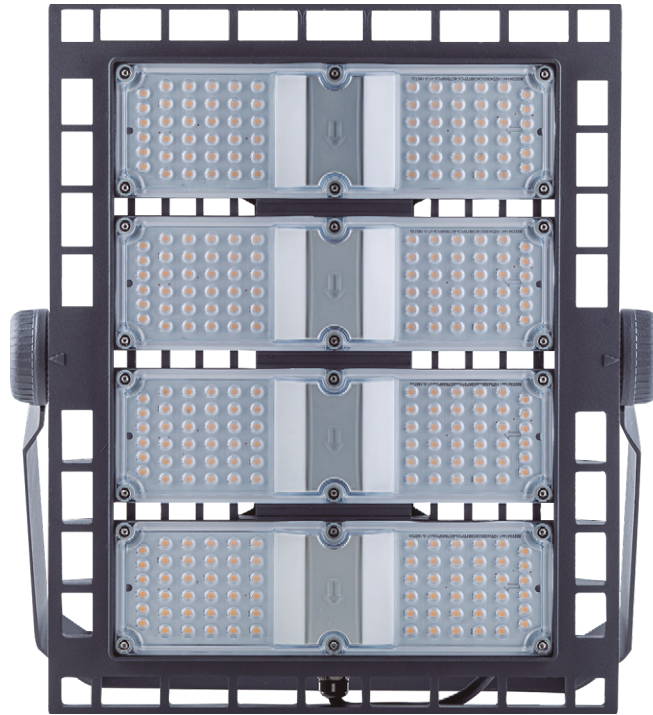

REGULABLE
soporte regulable con descripción de grados

FUENTE MEANWELL
Multivoltaje AC100-240V

LED BRIDGELUX
Chip SMD3030
170lm por Watt

IK08 / IP66
Cuerpo de fundición de aluminio alta presión



IK08
IP65
Protección Superior



ANTIHIGHVOLT
Protección contra sobretensiones de 1500V



Mayor Eficacia
Factor de Potencia Superior 0.9



140lm/Watt
Eficacia lumínica Mejorada



FUENTE MEANWELL
Multivoltaje 100-240V



100.000hs
Vida útil extendida

REFLECTOR 240W / IP65 / AC100-240V / 90° / 341x425x68mm					VIDA ÚTIL	MASTER	PRECIO SIN IVA
FL240DRWW	Cálido	3000°K	33600lm	140 lm/W	100.000hs	1u.	427,14 USD IVA 21%
FL240DRCW	Frío	5700°K	33600lm	140 lm/W	100.000hs	1u.	

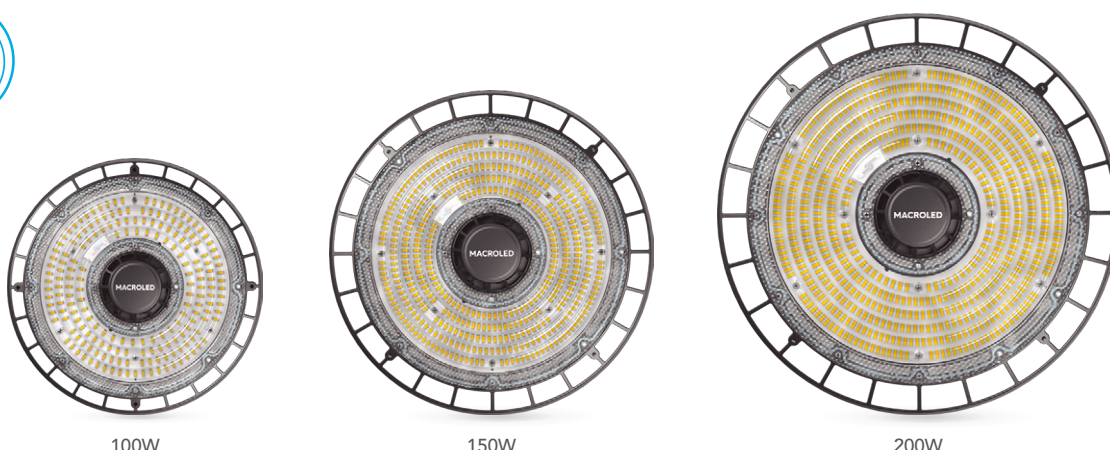

180lm/W
Eficiencia luminica



Dimerizable
Sensor o dimmer 0-10V



AC90-305V~
Rango multitenión



Protección SPD
Contra sobretensiones 6kV



Driver
Marca MOSO



IK08
IP66 Apto intemperie
Protección contra golpes y agua



50.000hs
Vida útil

HIGHBAY PRO / AC90-305V~	POTENCIA	APERTURA	TEMPERATURA	DIMENSIONES	LÚMENES	MASTER	PRECIO SIN IVA
PHB-100W-90D-857-CW	100W	90°	Frío 5700°K	250*250*118mm	18000lm	1u.	101,80 USD
PHB-150W-60D-857-CW	150W	60°	Frío 5700°K	280*280*118mm	27000lm	1u.	121,70 USD
PHB-150W-90D-857-CW	150W	90°	Frío 5700°K	280*280*118mm	27000lm	1u.	121,70 USD
PHB-200W-90D-857-CW	200W	90°	Frío 5700°K	316*316*118mm	36000lm	1u.	161,90 USD
							IVA 21%

Los accesorios se venden por separado.

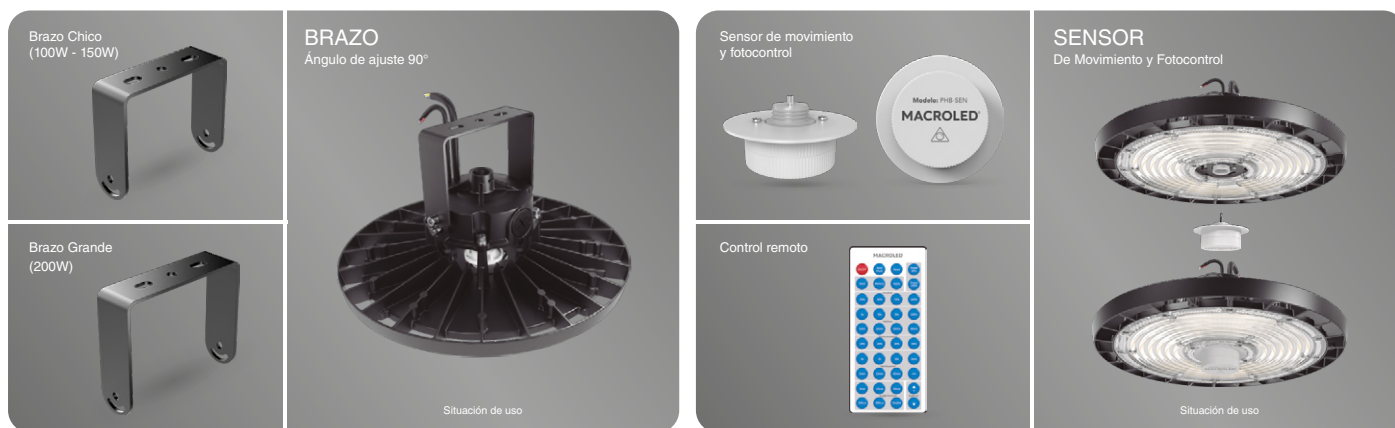

BRAZO PARA HIGHBAY PRO 100W -150W / 9,3x3,5x11cm	VENTA MIN.	MASTER	PRECIO SIN IVA
PHB-BRC	1u.	20u.	27,10 USD
BRAZO PARA HIGHBAY PRO 200W / 10,3x3,5x12,4cm	VENTA MIN.	MASTER	PRECIO SIN IVA
PHB-BRG	1u.	20u.	7,00 USD
			IVA 21%
SENSOR DE MOVIMIENTO Y FOTOCONTROL HIGHBAY PRO / 37x37x38,5cm	VENTA MIN.	MASTER	PRECIO SIN IVA
PHB-SEN	1u.	200u.	20,00 USD
CONTROL DE CONFIGURACION PARA SENSOR HIGHBAY PRO / 11.65*5.5*1.3cm	VENTA MIN.	MASTER	PRECIO SIN IVA
PHB-CONTROL	1u.	20u.	6,00 USD
			IVA 10,5%

HIGHBAY STANDARD



100W



150W



200W



Protección SPD
Contra sobretensiones 4kV



AC120-265V~
Tensión



150lm/W
Eficiencia luminica



50.000hs
Vida útil



Apto intemperie
Protección contra
golpes y agua

MODELO	POTENCIA	APERTURA	TEMPERATURA		DIMENSIONES	LÚMENES	VENTA MIN.	MASTER	PRECIO SIN IVA
SHB-100W-90D-857	100W	90°	Frío	5700°K	265*95mm	15000lm	5u.	5u.	77,70 USD
SHB-150W-60D-857	150W	60°	Frío	5700°K	290*150mm	22500lm	5u.	5u.	93,20 USD
SHB-150W-90D-857	150W	90°	Frío	5700°K	290*150mm	22500lm	5u.	5u.	93,20 USD
SHB-150W-90D-840	150W	90°	Neutro	4000°K	290*150mm	22500lm	5u.	5u.	93,20 USD
SHB-200W-90D-857	200W	90°	Frío	5700°K	346x150mm	30000lm	5u.	5u.	118,20 USD
									IVA 21%

HIGHBAY CLASSIC



IP65/IK08
Protección Superior
Aptas para vía pública



ANTIHIGHVOLT
Protección contra
sobretensiones de 1500V



Mayor Eficacia
Factor de Potencia
Superior 0.9



CÁNCAMO
Includido



SANAN SMD3030
Con chip Samsung, marca
líder en el mercado



50.000hs
Vida útil extendida

HIGHBAY 100W	POTENCIA	/ AC180-240V / 235x30mm				VIDA ÚTIL	MASTER	PRECIO SIN IVA
EHB-100W-CW	100W	Frío	6500°K	13000lm	130lm/W	50000hs	5u.	51,84 USD
HIGHBAY 150W	POTENCIA	/ AC180-240V / 260x35mm				VIDA ÚTIL	MASTER	PRECIO SIN IVA
EHB-150W-CW	150W	Frío	6500°K	19500lm	130lm/W	50000hs	5u.	75,98 USD
HIGHBAY 200W	POTENCIA	/ AC180-240V / 310x36mm				VIDA ÚTIL	MASTER	PRECIO SIN IVA
EHB-200W-CW	200W	Frío	6500°K	26000lm	130lm/W	50000hs	5u.	105,47 USD
21%								

BRAZO PARA HIGHBAY	POTENCIA	MEDIDAS	INTERMEDIA	MASTER	PRECIO SIN IVA
EHB-BR	100W / 150W / 200W	31.5x24x16cm	5u.	20u.	7,37 USD
					21%

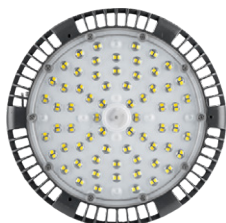

IP65/IK08
Protección Superior
Aptas para vía pública



140lm/Watt
Eficacia lumínica
Mejorada



Mayor Eficacia
Factor de Potencia
Superior 0.9



ANTIHIGHVOLT
Protección contra sobre-
tensiones de 1500V



SAMSUNG LED
Con chip Samsung, marca
líder en el mercado



50.000hs
Vida útil extendida

HIGHBAY 100W	POTENCIA	/ AC100-240V / 230x160mm				VIDA ÚTIL	MASTER	PRECIO SIN IVA
HBV2100P	100W	Frío	6500°K	14000lm	140lm/W	50000hs	4u.	103,43 USD
HIGHBAY 150W	POTENCIA	/ AC100-240V / 310x165mm				VIDA ÚTIL	MASTER	PRECIO SIN IVA
HBV2150P	150W	Frío	6500°K	21000lm	140lm/W	50000hs	2u.	128,00 USD
HIGHBAY 200W	POTENCIA	/ AC100-240V / 400x177mm				VIDA ÚTIL	MASTER	PRECIO SIN IVA
HBV2200P	200W	Frío	6500°K	28000lm	140lm/W	50000hs	2u.	164,00 USD
								21%



Modelos
LCL-150W-NM3
LCL-200W-NM3



*ZÓCALO NEMA 3
Incluye Shortcap
Fotocélula no incluida



LCL-SC



130lm/W
Eficiencia lumínica mejorada



MATRICERÍA SLIM
Liviano de maniobrar y fácil de colocar



IP65 / IK08
Protección certificada IK08 e IP67 contra el agua



ANTIHIGHVOLT
Protección contra sobre-tensiones SPD disponible de 1.5KV/3S



BRAZO REGULABLE
Para mayor precisión de la iluminación, rango de inclinación de 10° a 15°



MAYOR EFICACIA
Factor de Potencia Superior 0.9



CERTIFICADO IRAM
Seguridad Eléctrica bajo norma IEC



Ø64MM
Montaje en poste de 64mm de diámetro

LUMAX 50W / IP65 / AC165-265V / 460x135x86mm				VIDA ÚTIL	MASTER	VENTA MÍN.	PRECIO SIN IVA
LCL-50W-CW	Frío	5700°K	6500lm	25.000hs	10u.	1u.	30,90 USD
LCL-50W-NW	Neutro	4500°K	6500lm	25.000hs	10u.	1u.	21%

LUMAX 100W / IP65 / AC165-265V / 530x150x86mm				VIDA ÚTIL	MASTER	VENTA MÍN.	PRECIO SIN IVA
LCL-100W-CW	Frío	5700°K	13000lm	25.000hs	8u.	1u.	41,50 USD
LCL-100W-NW	Neutro	4500°K	13000lm	25.000hs	8u.	1u.	21%

LUMAX 150W / IP65 / AC165-265V / 620x175x86mm				VIDA ÚTIL	MASTER	VENTA MÍN.	PRECIO SIN IVA
LCL-150W-CW	Frío	5700°K	19500lm	25.000hs	6u.	1u.	61,20 USD
LCL-150W-NW	Neutro	4500°K	19500lm	25.000hs	6u.	1u.	21%

LUMAX 200W / IP65 / AC165-265V / 655x195x86mm				VIDA ÚTIL	MASTER	VENTA MÍN.	PRECIO SIN IVA
LCL-200W-CW	Frío	5700°K	26000lm	25.000hs	5u.	1u.	82,40 USD
LCL-200W-NW	Neutro	4500°K	26000lm	25.000hs	5u.	1u.	21%

LUMAX 150W con zócalo NEMA 3* / IP65 / AC165-265V / 620x175x86mm				VIDA ÚTIL	MASTER	VENTA MÍN.	PRECIO SIN IVA
LCL-150W-NM3-CW	Frío	5700°K	19500lm	25.000hs	6u.	1u.	77,70 USD
LCL-150W-NM3-NW	Neutro	4500°K	19500lm	25.000hs	6u.	1u.	21%

LUMAX 200W con zócalo NEMA 3* / IP65 / AC165-265V / 655x195x86mm				VIDA ÚTIL	MASTER	VENTA MÍN.	PRECIO SIN IVA
LCL-200W-NM3-CW	Frío	5700°K	26000lm	25.000hs	5u.	1u.	100,00 USD
LCL-200W-NM3-NW	Neutro	4500°K	26000lm	25.000hs	5u.	1u.	21%

CONECTOR SHORTCAP	Descripción	MASTER	VENTA MÍN.	PRECIO SIN IVA
LCL-SC	Conector para luminaria NEMA 3	100u.	1u.	6,00 USD
				21%



50W



100W / 150W



200W



IP65/IK08
Protección Superior



ANTIHIGHVOLT
Protección contra sobretensiones de 1500V



Mayor Eficacia
Factor de Potencia Superior 0.9



120lm/Watt
Eficacia luminica Mejorada



SEOUL LED
Con chip Seoul, marca líder en el mercado



Certificado IRAM
Seguridad Eléctrica bajo norma IEC

LUMINARIA PÚBLICA 50W / IP65 / AC100-265V / 380x160X41mm						MASTER	PRECIO SIN IVA
SL-50W-CW	Frío	5700°K	6000lm	120 lm/W	50000hs	6u.	72,50 USD
							IVA 21%

LUMINARIA PÚBLICA 100W / IP65 / AC100-265V / 480x230X47mm					VIDA ÚTIL	MASTER	PRECIO SIN IVA
SL-100W-CW	Frío	5700°K	12000lm	120 lm/W	50000hs	4u.	124,63 USD
							IVA 21%

LUMINARIA PÚBLICA 150W / IP65 / AC100-265V / 480x230X48mm					VIDA ÚTIL	MASTER	PRECIO SIN IVA
SL-150W-CW	Frío	5700°K	18000lm	120 lm/W	50000hs	4u.	165,09 USD
							IVA 21%

LUMINARIA PÚBLICA 200W / IP65 / AC100-240V / 542x262x86mm					VIDA ÚTIL	MASTER	PRECIO SIN IVA
SL-200W-CW	Frío	5700°K	24000lm	120 lm/W	50000hs	3u.	204,06 USD
							IVA 21%



IP65/IK08
Protección Superior



ANTIHIGHVOLT
Protección contra sobre-
tensiones de 1500V



Mayor Eficacia
Factor de Potencia
Superior 0.9



120lm/Watt
Eficacia luminica
Mejorada



SAMSUNG LED
Con chip Samsung, marca
líder en el mercado



Certificado IRAM
Seguridad Eléctrica
bajo norma IEC

FAROLA 50W / IP65 / AC100-240V / Ø377x375mm					VIDA ÚTIL	MASTER	PRECIO SIN IVA
FPL-50W-WW	Cálido	3000°K	6000lm	120 lm/W	30000hs	1u.	151,02 USD
FPL-50W-CW	Frío	5700°K	6000lm	120 lm/W	30000hs	1u.	
							IVA 21%

FAROLA 100W / IP65 / AC100-240V / Ø377x375mm					VIDA ÚTIL	MASTER	PRECIO SIN IVA
FPL-100W-WW	Cálido	3000°K	12000lm	120 lm/W	30000hs	1u.	200,45 USD
FPL-100W-CW	Frío	5700°K	12000lm	120 lm/W	30000hs	1u.	
							IVA 21%

FAROLA 140W / IP65 / AC100-240V / Ø377x375mm					VIDA ÚTIL	MASTER	PRECIO SIN IVA
FPL-140W-WW	Cálido	3000°K	16800lm	120 lm/W	30000hs	1u.	208,73 USD
FPL-140W-CW	Frío	5700°K	16800lm	120 lm/W	30000hs	1u.	
							IVA 21%



25.000hs
Vida útil

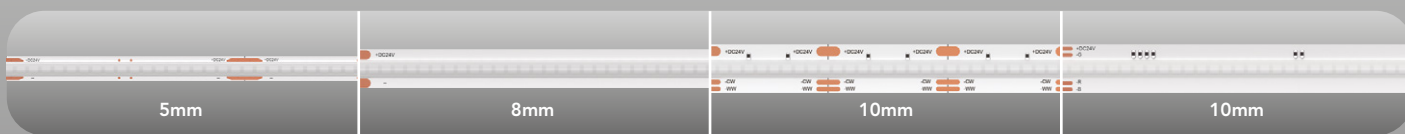

TIRA COB / 5mm / IP20 / 24V / Rollo de 5m					CHIPS COB	MASTER	VENTA MIN	PRECIO SIN IVA
TCOB320-24V-5MM-IP20-WW	Cálido	2700°K	8W/m	90lm/W	320 led/m	50u.	1u.	13,30 USD
TCOB480-24V-5MM-IP20-WW	Cálido	2700°K	8W/m	90lm/W	480 led/m	50u.	1u.	19,75 USD
								IVA 10,5%

TIRA COB / 8mm / IP20 / 24V / Rollo de 5m					CHIPS COB	MASTER	VENTA MIN	PRECIO SIN IVA
TCOB320-24V-8MM-IP20-CW	Frío	6500°K	10W/m	100lm/W	320 led/m	50u.	1u.	14,92 USD
TCOB320-24V-8MM-IP20-NW	Neutro	4000°K	10W/m	100lm/W	320 led/m	50u.	1u.	
TCOB320-24V-8MM-IP20-WW	Cálido	2700°K	10W/m	100lm/W	320 led/m	50u.	1u.	14,92 USD
TCOB320-24V-8MM-IP20-AW	Ámbar	2200°K	10W/m	100lm/W	320 led/m	50u.	1u.	
TCOB320-24V-8MM-IP20-B	Azul	-	10W/m	100lm/W	320 led/m	50u.	1u.	21,43 USD
TCOB480-24V-8MM-IP20-CW	Frío	6500°K	10W/m	100lm/W	480 led/m	50u.	1u.	
TCOB480-24V-8MM-IP20-NW	Neutro	4000°K	10W/m	100lm/W	480 led/m	50u.	1u.	21,43 USD
TCOB480-24V-8MM-IP20-WW	Cálido	2700°K	10W/m	100lm/W	480 led/m	50u.	1u.	
TCOB480-24V-8MM-IP20-AW	Ámbar	2200°K	10W/m	100lm/W	480 led/m	50u.	1u.	21,43 USD
TCOB480-24V-8MM-IP20-B	Azul	-	10W/m	100lm/W	480 led/m	50u.	1u.	
								IVA 10,5%

TIRA COB / 10mm / IP20 / 24V / Rollo de 5m					CHIPS COB	MASTER	VENTA MIN	PRECIO SIN IVA
TCOB640-24V-10MM-IP20-CCT	Blancos dinámicos	2700°K - 6500°K	8+8W/m	90lm/W	640 led/m	50u.	1u.	53,90 USD
TCOB630-24V-10MM-IP20-RGB	RGB	-	-	-	630 led/m	50u.	1u.	44,45 USD
TCOB630-24V-10MM-IP65-RGB	RGB	-	-	-	630 led/m	50u.	1u.	49,28 USD
								IVA 10,5%



ITAT-5MM-2P

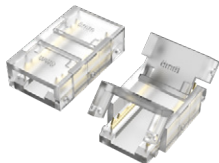

ITAT-8MM-2P

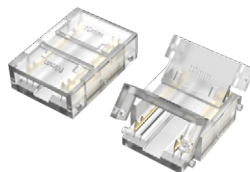

ITAT-10MM-3P

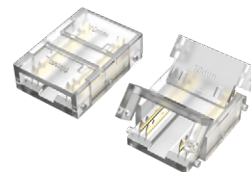

ITAT-10MM-4P

INTERCONECTOR TIRA A TIRA	COMPATIBILIDAD	PINES	MASTER	VENTA MIN	PRECIO SIN IVA
ITAT-5MM-2P	TIRAS COB 5MM	2	500u.	50u.	0,63 USD
ITAT-8MM-2P	TIRAS COB 8MM	2	2000u.	50u.	0,75 USD
ITAT-10MM-3P	TIRAS COB 10MM	3	2000u.	50u.	0,86 USD
ITAT-10MM-4P	TIRAS COB 10MM	4	2000u.	50u.	0,86 USD



ICAT-5MM-2P



ICAT-8MM-2P

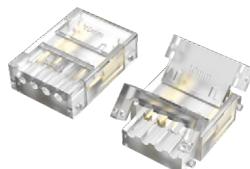

ICAT-10MM-3P

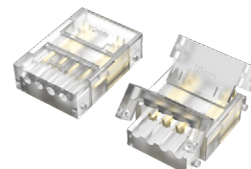

ICAT-10MM-4P

INTERCONECTOR CABLE A TIRA	COMPATIBILIDAD	PINES	MASTER	VENTA MIN	PRECIO SIN IVA
ICAT-5MM-2P	TIRAS COB 5MM	2	500u.	50u.	0,63 USD
ICAT-8MM-2P	TIRAS COB Y SMD 8MM*	2	2000u.	50u.	0,75 USD
ICAT-10MM-3P	TIRAS COB 10MM	3	2000u.	50u.	0,86 USD
ICAT-10MM-4P	TIRAS COB 10MM	4	2000u.	50u.	0,86 USD

*Compatible con tiras LED SMD Macroled: modelos 2835 y 3528.

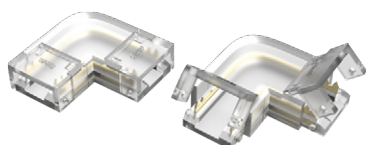

ITAT-L-8MM-2P

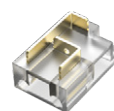

ITAT-T-8MM-2P

INTERCONECTOR TIRA A TIRA TIPO L	COMPATIBILIDAD	PINES	MASTER	VENTA MIN	PRECIO SIN IVA
ITAT-L-8MM-2P	TIRAS COB 8MM	2	2000u.	50u.	1,60 USD

INTERCONECTOR TIRA A TIRA TIPO T	COMPATIBILIDAD	PINES	MASTER	VENTA MIN	PRECIO SIN IVA
ITAT-T-8MM-2P	TIRAS COB 8MM	2	2000u.	50u.	2,35 USD



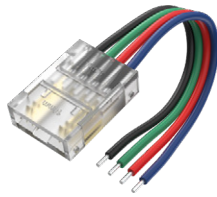

CCAT-5MM-2P

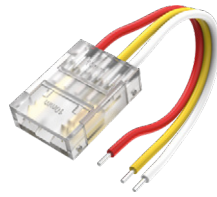

CCAT-8MM-2P



CCAT-10MM-3P



CCAT-10MM-4P

CONECTOR CON CABLE A TIRA	COMPATIBILIDAD	PINES	CABLE	MASTER	VENTA MIN	PRECIO SIN IVA
CCAT-5MM-2P	TIRAS COB 5MM	2	10cm	500u.	50u.	0,86 USD
CCAT-8MM-2P	TIRAS COB Y SMD 8MM*	2	10cm	2000u.	50u.	1,09 USD
CCAT-10MM-3P	TIRAS COB 10MM	3	10cm	2000u.	50u.	1,32 USD
CCAT-10MM-4P	TIRAS COB 10MM	4	10cm	2000u.	50u.	1,32 USD

*Compatible con tiras LED SMD Macroled: modelos 2835 y 3528.

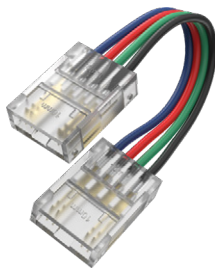

ICAT-5MM-2P

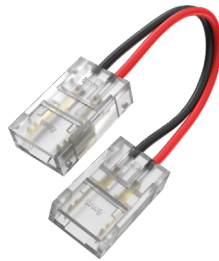

ICAT-8MM-2P

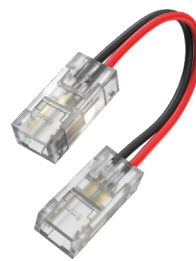

ICAT-10MM-3P

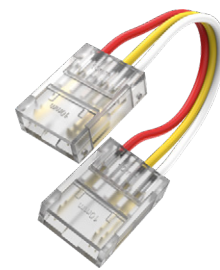

ICAT-10MM-4P

CONECTOR CON CABLE A TIRA	COMPATIBILIDAD	PINES	CABLE	MASTER	VENTA MIN	PRECIO SIN IVA
ITATC-5MM-2P	TIRAS COB 5MM	2	10cm	500u.	50u.	1,48 USD
ITATC-8MM-2P	TIRAS COB Y SMD 8MM*	2	10cm	2000u.	50u.	1,82 USD
ITATC-10MM-3P	TIRAS COB 10MM	3	10cm	2000u.	50u.	2,16 USD
ITATC-10MM-4P	TIRAS COB 10MM	4	10cm	2000u.	50u.	2,16 USD

*Compatible con tiras LED SMD Macroled: modelos 2835 y 3528.

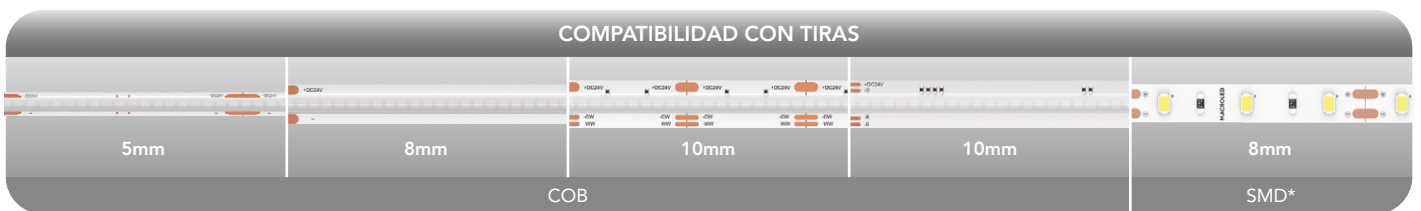



Barrido de Mano
Alcance: 10-15cm



SENT-SWAP*



Detección de movimiento
Alcance: 2.4-3mts



SENT-PIR*



Táctil y Dimerizable



SENT-DIM



Apertura de Puerta Simple
Alcance: 1-8cm



SENT-PS*



Apertura de Puerta Doble
Alcance: 1-8cm



SENT-PD*



SENSORES ON/OFF 12V/36W MÁX. - 24V/72W MÁX.		TAMAÑO	LARGO DEL CABLE	MASTER	VENTA MIN	PRECIO SIN IVA
SENT-SWAP	Sensor de Barrido de Mano	Ø12x12mm	10cm	200u.	1u.	11,90 USD
SENT-PIR	Sensor de Movimiento	Ø16mm	10cm	200u.	1u.	
SENT-DIM	Sensor Táctil y Dimerizable	Ø16x12mm	10cm	200u.	1u.	
SENT-PS	Sensor Apertura de Puerta Simple	Ø12mm	10cm	200u.	1u.	
SENT-PD	Sensor Apertura de Puerta Doble	Ø12mm c/u	10cm	200u.	1u.	13,85 USD
						IVA 21%

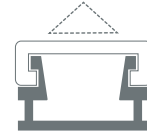

- Difusor PC
- Cuerpo Aluminio

Unidireccional

PARA APLICAR - 12X7mm	COLOR	ANCHO MÁX. DE TIRA	DIMENSIONES	MASTER	VENTA MIN.	PRECIO SIN IVA
PAL-AP-B-12X7-8MM-2M	○ Blanco	8mm	2000x12x7.5mm	60u.	10u.	5,88 USD
PAL-AP-AL-12X7-8MM-2M	● Aluminio	8mm	2000x12x7.5mm	60u.	10u.	5,28 USD
PAL-AP-N-12X7-8MM-2M	● Negro	8mm	2000x12x7.5mm	60u.	10u.	5,88 USD

ACCESORIOS - 12X7mm	COLOR	MATERIAL	DIMENSIONES	MASTER	VENTA MIN.	PRECIO SIN IVA
PAL-END-AP-AL-12X7	● Aluminio	PC	12x7.5x5mm	500u.	50u.	0,12 USD
PAL-END-AP-B-12X7	○ Blanco	PC	12x7.5x5mm	500u.	50u.	0,12 USD
PAL-END-AP-N-12X7	● Negro	PC	12x7.5x5mm	500u.	50u.	0,12 USD
PAL-CLIP-AP-B-12X7	○ Blanco	Metal	12x7.5x5mm	500u.	50u.	0,30 USD
PAL-CLIP-AP-AL-12X7	● Aluminio	Metal	12x7.5x5mm	500u.	50u.	0,10 USD
PAL-CLIP-AP-N-12X7	● Negro	Metal	12x7.5x5mm	500u.	50u.	0,30 USD



- Difusor PC
- Cuerpo Aluminio

Unidireccional

BARRAL PARA PLACARD - 29X14mm	COLOR	ANCHO MÁX. DE TIRA	DIMENSIONES	MASTER	VENTA MIN.	PRECIO SIN IVA
PAL-PER-AL-29X14-12MM-2M	● Aluminio	12mm	2000x29x14.5mm	20u.	10u.	17,90 USD
PAL-PER-N-29X14-12MM-2M	● Negro	12mm	2000x29x14.5mm	20u.	10u.	18,20 USD

ACCESORIOS - 29X14mm	COLOR	MATERIAL	DIMENSIONES	MASTER	VENTA MIN.	PRECIO SIN IVA
PAL-ACC1-PER-N-ST	● Negro	Metal	40x70x10mm	500u.	10u.	2,70 USD
PAL-ACC1-PER-AL-ST	● Aluminio	Metal	40x70x10mm	500u.	10u.	2,55 USD
PAL-ACC2-PER-AL-SP	● Negro	Metal	18x47x11mm	500u.	10u.	1,70 USD
PAL-ACC2-PER-AL-SP	● Aluminio	Metal	18x47x11mm	500u.	10u.	1,70 USD

Cada bolsa unitaria contiene 10 piezas (para 5 perfiles)

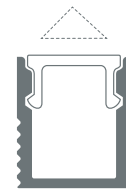

Unidireccional

- Difusor PC
- Cuerpo Aluminio

PARA APLICAR - 8X9mm	COLOR	ANCHO MÁX. DE TIRA	DIMENSIONES	MASTER	VENTA MIN.	PRECIO SIN IVA
PAL-AP-B-8X9-5MM-2M	○ Blanco	5mm	2000x7,8x9mm	100u.	10u.	5,15 USD
PAL-AP-AL-8X9-5MM-2M	● Aluminio	5mm	2000x7,8x9mm	100u.	10u.	4,58 USD
PAL-AP-N-8X9-5MM-2M	● Negro	5mm	2000x7,8x9mm	100u.	10u.	5,15 USD

ACCESORIOS - 8X9MM	COLOR	MATERIAL	DIMENSIONES	MASTER	VENTA MIN.	PRECIO SIN IVA
PAL-END-AP-B-8X9	○ Blanco	PC	12x7.5x5mm	500u.	50u.	0,12 USD
PAL-END-AP-AL-8X9	● Aluminio	PC	12x7.5x5mm	500u.	50u.	0,12 USD
PAL-END-AP-N-8X9	● Negro	PC	12x7.5x5mm	500u.	50u.	0,12 USD
PAL-CLIP-AP-B-8X9	○ Blanco	Metal	12x7.5x5mm	500u.	50u.	0,30 USD
PAL-CLIP-AP-AL-8X9	● Aluminio	Metal	12x7.5x5mm	500u.	50u.	0,10 USD
PAL-CLIP-AP-N-8X9	● Negro	Metal	12x7.5x5mm	500u.	50u.	0,30 USD

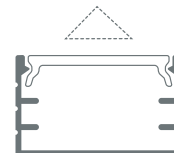
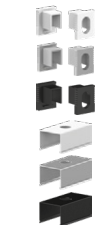

Unidireccional

- Difusor PC
- Cuerpo Aluminio



PARA APLICAR - 14X8mm	COLOR	ANCHO MÁX. DE TIRA	DIMENSIONES	MASTER	VENTA MIN.	PRECIO SIN IVA
PAL-AP-B-14X8-12MM-2M	○ Blanco	12mm	2000x14.2x8.5mm	90u.	10u.	5,36 USD
PAL-AP-AL-14X8-12MM-2M	● Aluminio	12mm	2000x14.2x8.5mm	90u.	10u.	4,78 USD
PAL-AP-N-14X8-12MM-2M	● Negro	12mm	2000x14.2x8.5mm	90u.	10u.	5,36 USD

ACCESORIOS - 14X8mm	COLOR	MATERIAL	DIMENSIONES	MASTER	VENTA MIN.	PRECIO SIN IVA
PAL-END-AP-N-14X8	● Negro	PC	14x9x7mm	500u.	50u.	0,12 USD
PAL-END-AP-AL-14X8	● Aluminio	PC	14x9x7mm	500u.	50u.	0,12 USD
PAL-END-AP-B-14X8	○ Blanco	PC	14x9x7mm	500u.	50u.	0,12 USD
PAL-CLIP-AP-N-14X8	● Negro	Metal	16x7x10mm	500u.	50u.	0,30 USD
PAL-CLIP-AP-AL-14X8	● Aluminio	Metal	16x7x10mm	500u.	50u.	0,10 USD
PAL-CLIP-AP-B-14X8	○ Blanco	Metal	16x7x10mm	500u.	50u.	0,30 USD



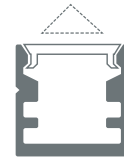

Unidireccional

- Difusor PC
- Cuerpo Aluminio

PARA APLICAR - 10X10mm	COLOR	ANCHO MÁX. DE TIRA	DIMENSIONES	MASTER	VENTA MIN.	PRECIO SIN IVA
PAL-AP-B-10X10-8MM-2M	○ Blanco	8mm	2000x10x10mm	100u.	10u.	5,31 USD
PAL-AP-AL-10X10-8MM-2M	● Aluminio	8mm	2000x10x10mm	100u.	10u.	5,03 USD
PAL-AP-N-10X10-8MM-2M	● Negro	8mm	2000x10x10mm	100u.	10u.	5,31 USD

ACCESORIOS - 10X10mm	COLOR	MATERIAL	DIMENSIONES	MASTER	VENTA MIN.	PRECIO SIN IVA
PAL-END-AP-B-10X10-8MM-2M	○ Blanco	PC	10x10x6mm	500u.	50u.	0,12 USD
PAL-END-AP-AL-10X10-8MM-2M	● Aluminio	PC	10x10x6mm	500u.	50u.	0,12 USD
PAL-END-AP-N-10X10-8MM-2M	● Negro	PC	10x10x6mm	500u.	50u.	0,12 USD
PAL-CLIP-AP-B-10X10-8MM-2M	○ Blanco	Metal	12x7x8mm	500u.	50u.	0,30 USD
PAL-CLIP-AP-AL-10X10-8MM-2M	● Aluminio	Metal	12x7x8mm	500u.	50u.	0,10 USD
PAL-CLIP-AP-N-10X10-8MM-2M	● Negro	Metal	12x7x8mm	500u.	50u.	0,30 USD

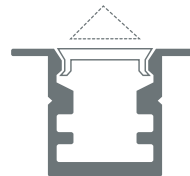

Unidireccional

- Difusor PC
- Cuerpo Aluminio



PARA EMBUTIR - 15X10mm	COLOR	ANCHO MÁX. DE TIRA	DIMENSIONES	MASTER	VENTA MIN.	PRECIO SIN IVA
PAL-EM-B-15X10-8MM-2M	○ Blanco	8mm	2000x15.6x10mm	100u.	10u.	5,40 USD
PAL-EM-AL-15X10-8MM-2M	● Aluminio	8mm	2000x15.6x10mm	100u.	10u.	5,20 USD
PAL-EM-N-15X10-8MM-2M	● Negro	8mm	2000x15.6x10mm	100u.	10u.	5,40 USD

ACCESORIOS - 15X10mm	COLOR	MATERIAL	DIMENSIONES	MASTER	VENTA MIN.	PRECIO SIN IVA
PAL-END-EM-B-15X10-8MM-2M	○ Blanco	PC	17x11x11mm	500u.	50u.	0,12 USD
PAL-END-EM-AL-15X10-8MM-2M	● Aluminio	PC	17x11x11mm	500u.	50u.	0,12 USD
PAL-END-EM-N-15X10-8MM-2M	● Negro	PC	17x11x11mm	500u.	50u.	0,12 USD



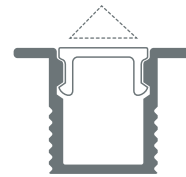

- Difusor PC
- Cuerpo Aluminio

Unidireccional

PARA EMBUTIR - 12X9mm	COLOR	ANCHO MÁX. DE TIRA	DIMENSIONES	MASTER	VENTA MIN.	PRECIO SIN IVA
PAL-EM-B-12X9-5MM-2M	○ Blanco	5mm	2000x12.4x9mm	100u.	10u.	5,22 USD
PAL-EM-AL-12X9-5MM-2M	● Aluminio	5mm	2000x12.4x9mm	100u.	10u.	4,93 USD
PAL-EM-N-12X9-5MM-2M	● Negro	5mm	2000x12.4x9mm	100u.	10u.	5,22 USD

ACCESORIOS - 12X9mm	COLOR	MATERIAL	DIMENSIONES	MASTER	VENTA MIN.	PRECIO SIN IVA
PAL-END-EM-B-12X9	○ Blanco	PC	13x9x11mm	500u.	50u.	0,12 USD
PAL-END-EM-AL-12X9	● Aluminio	PC	13x9x11mm	500u.	50u.	0,12 USD
PAL-END-EM-N-12X9	● Negro	PC	13x9x11mm	500u.	50u.	0,12 USD

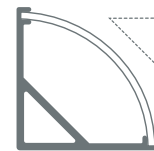

- Difusor PC
- Cuerpo Aluminio

Unidireccional

PARA APLICAR - 16X16mm	COLOR	ANCHO MÁX. DE TIRA	DIMENSIONES	MASTER	VENTA MIN.	PRECIO SIN IVA
PAL-ESQ-AL-16X16-10MM-2M	○ Blanco	10mm	2000x15.8x15.8mm	60u.	10u.	6,00 USD

ACCESORIOS - 16X16mm	COLOR	MATERIAL	DIMENSIONES	MASTER	VENTA MIN.	PRECIO SIN IVA
PAL-END-ESQ-AL-16X16	○ Blanco	PC	14x17x17mm	500u.	50u.	0,12 USD
PAL-CLIP-ESQ-AL-16X16	● Aluminio	PC	14x17x17mm	500u.	50u.	0,10 USD



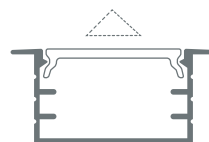

○ Difusor PC
● Cuerpo Aluminio

Unidireccional

PARA EMBUTIR - 18X8mm	COLOR	ANCHO MÁX. DE TIRA	DIMENSIONES	MASTER	VENTA MIN.	PRECIO SIN IVA
PAL-EM-B-18X8-12MM-2M	○ Blanco	12mm	2000x18.4x8.5mm	90u.	10u.	5,75 USD
PAL-EM-AL-18X8-12MM-2M	● Aluminio	12mm	2000x18.4x8.5mm	90u.	10u.	5,30 USD
PAL-EM-N-18X8-12MM-2M	● Negro	12mm	2000x18.4x8.5mm	90u.	10u.	5,50 USD

ACCESORIOS - 18X8mm	COLOR	MATERIAL	DIMENSIONES	MASTER	VENTA MIN.	PRECIO SIN IVA
PAL-END-EM-B-18X8	○ Blanco	PC	18x9x14mm	500u.	50u.	0,12 USD
PAL-END-EM-AL-18X8	● Aluminio	PC	18x9x14mm	500u.	50u.	0,12 USD
PAL-END-EM-N-18X8	● Negro	PC	18x9x14mm	500u.	50u.	0,12 USD

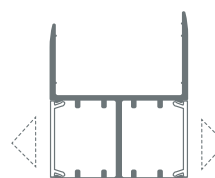

○ Difusor PC
● Cuerpo Aluminio

Bidireccional



PARA EMBUTIR - 28X20mm	COLOR	ANCHO MÁX. DE TIRA	DIMENSIONES	MASTER	VENTA MIN.	PRECIO SIN IVA
PAL-EM-N-15X10-8MM-2M	○ Blanco	12mm	2000x28x20mm	100u.	10u.	5,40 USD
PAL-EM-AL-15X10-8MM-2M	● Negro	12mm	2000x28x20mm	100u.	10u.	5,20 USD

ACCESORIOS - 28x20mm	COLOR	MATERIAL	DIMENSIONES	MASTER	VENTA MIN.	PRECIO SIN IVA
PAL-END-BD-B-28X20	○ Blanco	PC	15x20x6mm	500u.	50u.	0,12 USD
PAL-END-BD-N-28X20	● Negro	PC	15x20x6mm	500u.	50u.	0,12 USD



25.000hs
Vida útil

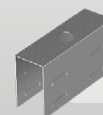

NEON-CLIP-6X12
Incluye 15
clips de fijación

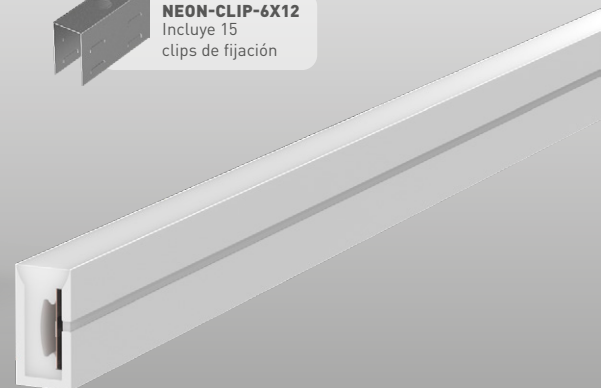

TIRA NEON / 6x12mm / IP65 / 24V / Rollo de 5m	LED					MASTER	VENTA MIN	PRECIO SIN IVA
NEON-6X12-24V-IP65-WW	Cálido	2700°K	10W/m	500lm/m	SMD 2835 - 140 led/m	18u.	1u.	33,25 USD
NEON-6X12-24V-IP65-NW	Neutro	4000°K	10W/m	500lm/m	SMD 2835 - 140 led/m	18u.	1u.	27,34 USD
								IVA 10,5%



25.000hs
Vida útil

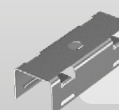

NEON-CLIP-10X10
Incluye 15
clips de fijación



TIRA NEON / 10x10mm / IP65 / 24V / Rollo de 5m	LED					MASTER	VENTA MIN	PRECIO SIN IVA
NEON-10X10-24V-IP65-WW	Cálido	2700°K	10W/m	700lm/m	SMD 2835 - 140 led/m	20u.	1u.	32,36 USD
NEON-10X10-24V-IP65-NW	Neutro	4000°K	10W/m	700lm/m	SMD 2835 - 140 led/m	20u.	1u.	27,34 USD
								IVA 10,5%



25.000hs
Vida útil

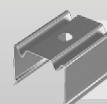

NEON-CLIP-15X15
Incluye 15
clips de fijación



TIRA NEON / 15x15mm / IP65 / 24V / Rollo de 5m					LED	MASTER	VENTA MIN	PRECIO SIN IVA
NEON-15X15-24V-IP65-WW	Cálido	2700°K	10W/m	700lm/m	SMD 2835 - 140 led/m	12u.	1u.	96,01 USD
NEON-15X15-24V-IP65-NW	Neutro	4000°K	10W/m	700lm/m	SMD 2835 - 140 led/	12u.	1u.	78,96 USD
NEON-15X15-24V-IP65-RGB	RGB	-	14W/m	-	SMD 5050 - 60 led/m	12u.	1u.	105,33 USD
NEON-15X15-24V-IP65-RGBW	RGBW	-	14+5W/m	-	SMD 2835 - 60+60 led/m	12u.	1u.	131,94 USD
								IVA 10,5%



25.000hs
Vida útil

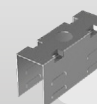

NEON-CLIP-10X20
Incluye 15
clips de fijación

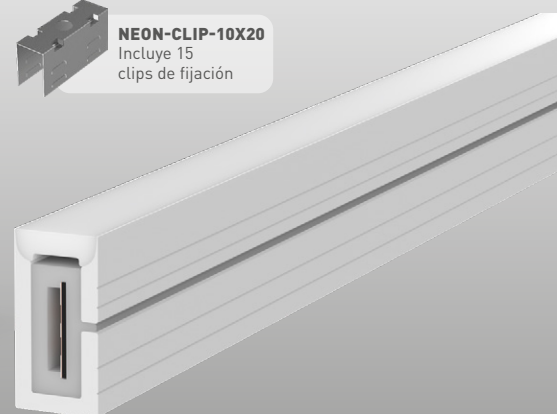

TIRA NEON / 10x20mm / IP65 / 24V / Rollo de 5m					LED	MASTER	VENTA MIN	PRECIO SIN IVA
NEON-10X20-24V-IP65-WW	Cálido	2700°K	10W/m	500lm/m	SMD 2835 - 140 led/m	12u.	1u.	128,43 USD
NEON-10X20-24V-IP65-NW	Neutro	4000°K	10W/m	500lm/m	SMD 2835 - 140 led/m	12u.	1u.	105,62 USD
NEON-10X20-24V-IP65-RGB	RGB	-	14W/m	-	SMD 5050 - 60 led/m	12u.	1u.	152,37 USD
NEON-10X20-24V-IP65-RGBW	RGBW	-	14+5W/m	-	SMD 2835 - 60+60 led/m	12u.	1u.	131,03 USD
								IVA 10,5%

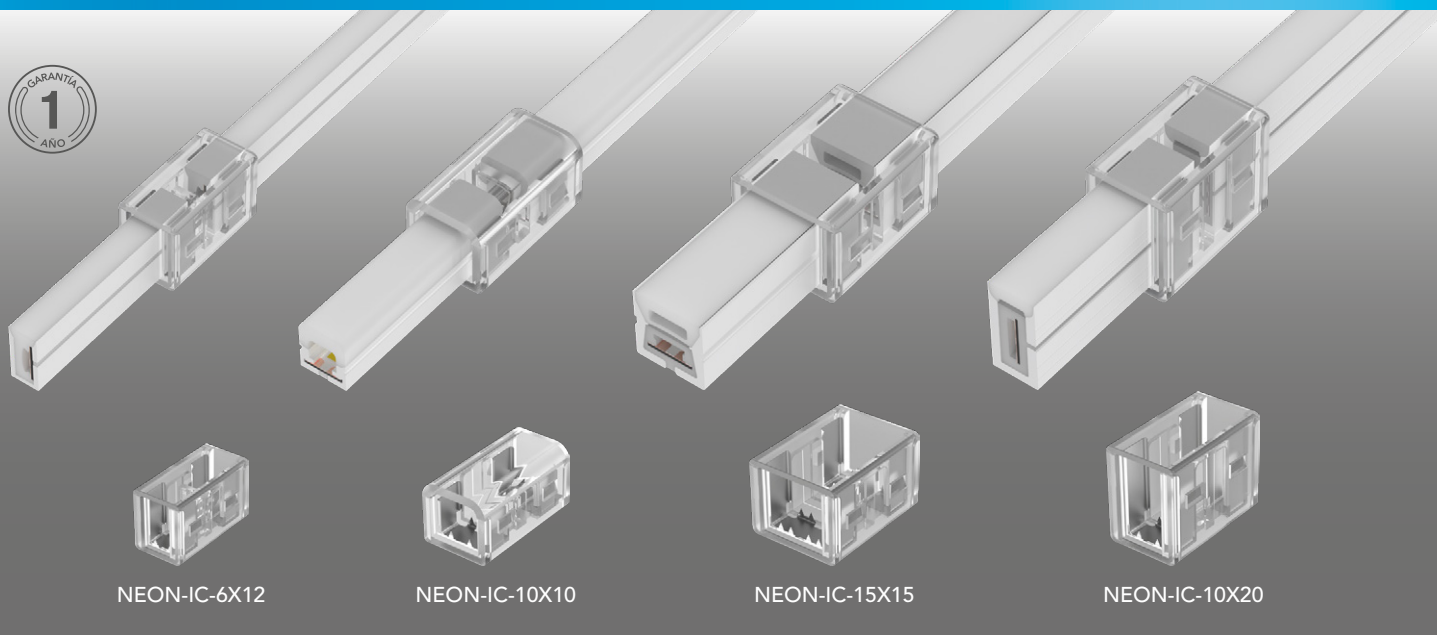

INTERCONECTOR TIRA A TIRA TRANSPARENTE	COMPATIBILIDAD	MASTER	VENTA MIN	PRECIO SIN IVA
NEON-IC-6X12	PARA TIRAS NEON 6X12	100u.	5u.	5,78 USD
NEON-IC-10X10	PARA TIRAS NEON 10X10	100u.	5u.	5,78 USD
NEON-IC-15X15	PARA TIRAS NEON 15X15	100u.	5u.	7,07 USD
NEON-IC-10X20	PARA TIRAS NEON 10X20	100u.	5u.	7,07 USD
				IVA 21%

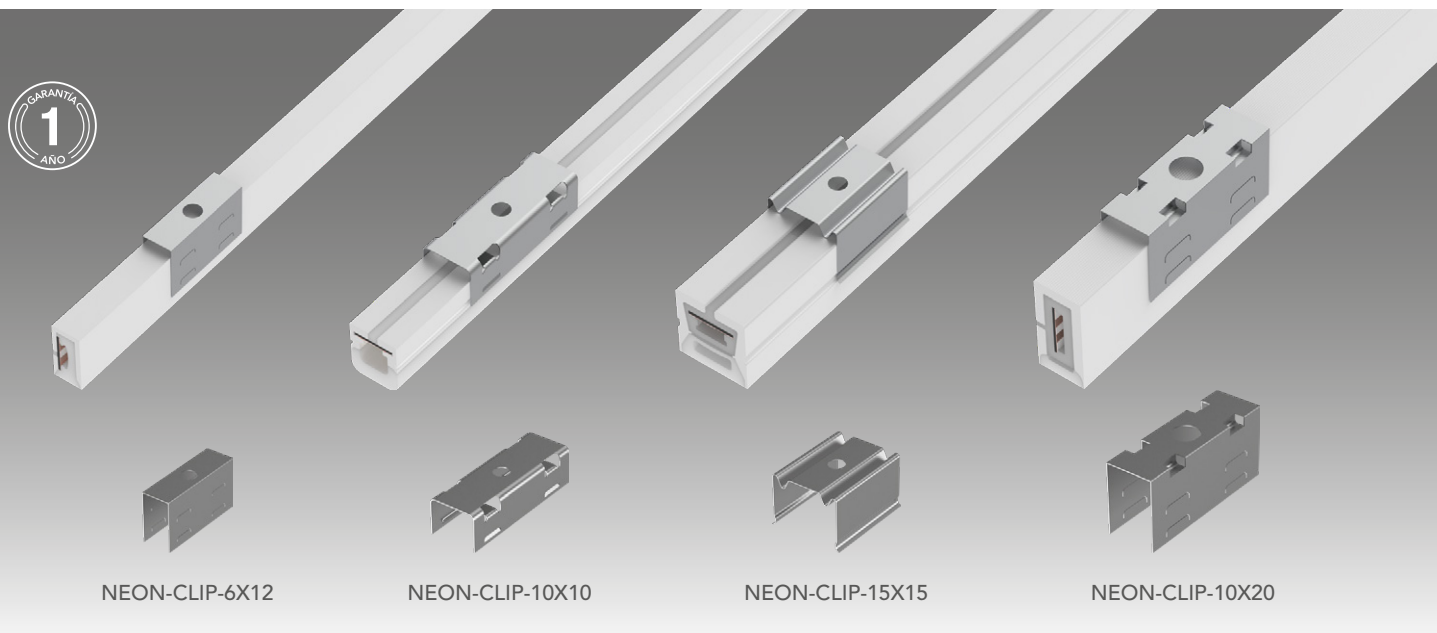

CLIP DE FIJACIÓN	COMPATIBILIDAD	MASTER	VENTA MIN	PRECIO SIN IVA
NEON-CLIP-6X12	PARA TIRAS NEON 6X12	1500u.	50u.	0,80 USD
NEON-CLIP-10X10	PARA TIRAS NEON 10X10	1500u.	50u.	
NEON-CLIP-15X15	PARA TIRAS NEON 15X15	1500u.	50u.	
NEON-CLIP-10X20	PARA TIRAS NEON 10X20	1500u.	50u.	
				IVA 21%

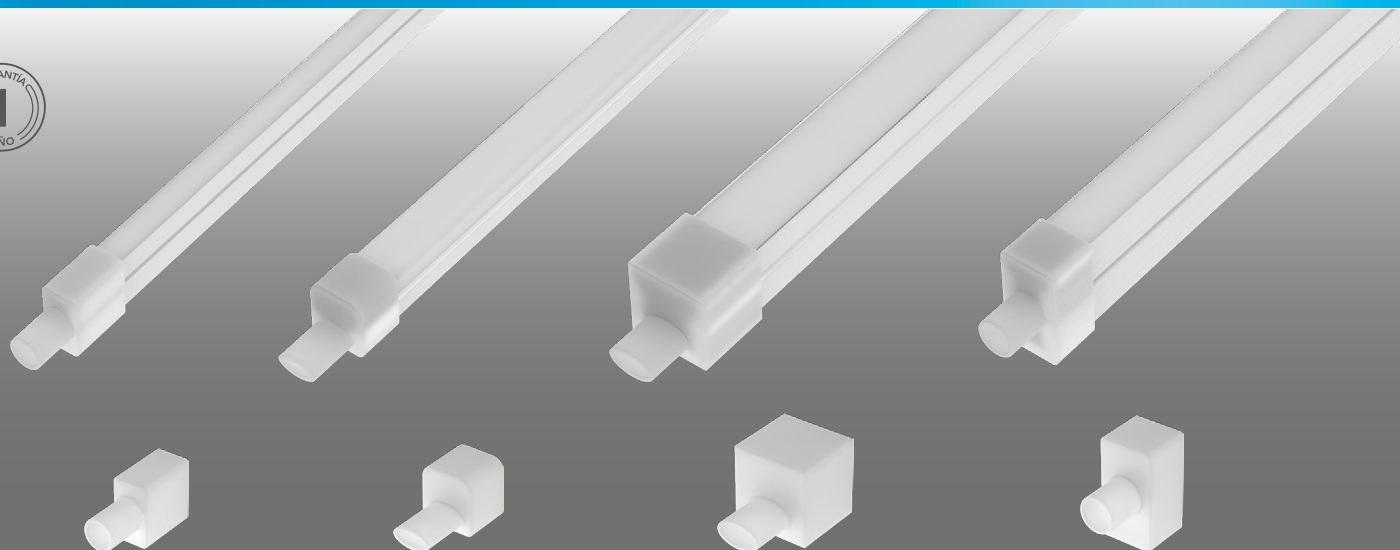

NEON-END-C-6X12

NEON-END-C-10X10

NEON-END-C-15X15

NEON-END-C-10X20

ENDCAP DE SILICONA CON SALIDA A CABLE	COMPATIBILIDAD	MASTER	VENTA MIN	PRECIO SIN IVA
NEON-END-C-6X12	PARA TIRAS NEON 6X12	2000u.	50u.	1,15 USD
NEON-END-C-10X10	PARA TIRAS NEON 10X10	2000u.	50u.	
NEON-END-C-15X15	PARA TIRAS NEON 15X15	2000u.	50u.	
NEON-END-C-10X20	PARA TIRAS NEON 10X20	2000u.	50u.	

IVA 21%

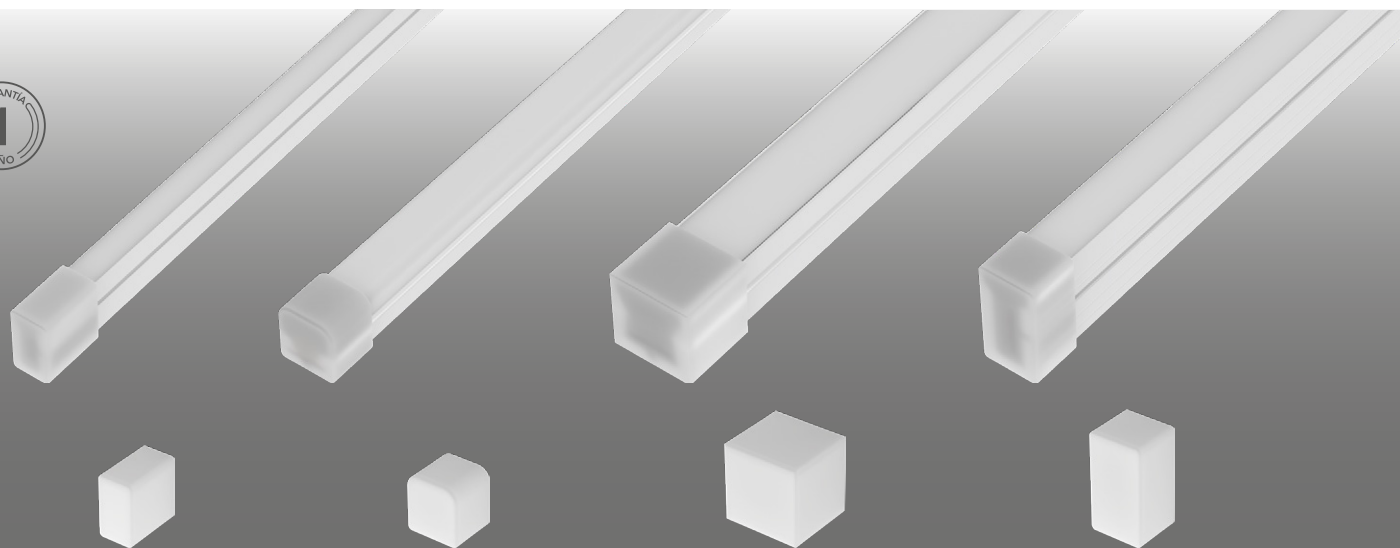

NEON-END-6X12

NEON-END-10X10

NEON-END-15X15

NEON-END-10X20

ENDCAP DE SILICONA	COMPATIBILIDAD	MASTER	VENTA MIN	PRECIO SIN IVA
NEON-END-6X12	PARA TIRAS NEON 6X12	2000u.	50u.	1,15 USD
NEON-END-10X10	PARA TIRAS NEON 10X10	2000u.	50u.	
NEON-END-15X15	PARA TIRAS NEON 15X15	2000u.	50u.	
NEON-END-10X20	PARA TIRAS NEON 10X20	2000u.	50u.	

IVA 21%



25.000hs
Vida útil

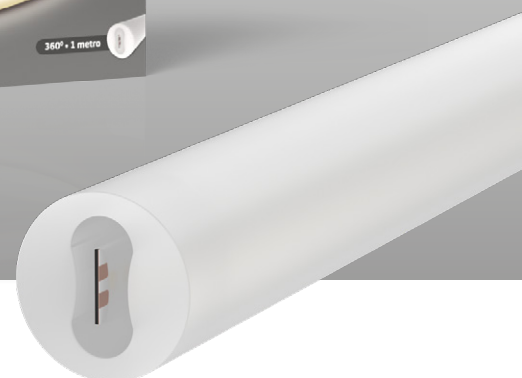

TIRA NEON 360° / IP65 / 24V / Rollo 1m x Ø25mm						LED	MASTER	VENTA MIN	PRECIO SIN IVA
NEON-360-1M-24V-IP65-WW	Cálido	2700°K	15W/m	900lm/m	SMD 2835 - 320 led/m	10u.	1u.	45,16 USD	
NEON-360-1M-24V-IP65-NW	Neutro	4000°K	15W/m	900lm/m	SMD 2835 - 320 led/m	10u.	1u.		
NEON-360-1M-24V-IP65-RGB	RGB	-	10W/m	310lm/m	SMD 2835 - 240 led/m	10u.	1u.	60,31 USD	
IVA 10,5%									

TIRA NEON 360° / IP65 / 24V / Rollo 3m x Ø25mm						LED	MASTER	VENTA MIN	PRECIO SIN IVA
NEON-360-3M-24V-IP65-WW	Cálido	2700°K	15W/m	900lm/m	SMD 2835 - 320 led/m	2u.	1u.	121,96 USD	
NEON-360-3M-24V-IP65-NW	Neutro	4000°K	15W/m	900lm/m	SMD 2835 - 320 led/m	2u.	1u.		
NEON-360-3M-24V-IP65-RGB	RGB	-	10W/m	310lm/m	SMD 2835 - 240 led/m	2u.	1u.	164,52 USD	
IVA 10,5%									

TIRA NEON 360° / IP65 / 24V / Rollo 5m x Ø25mm						LED	MASTER	VENTA MIN	PRECIO SIN IVA
NEON-360-5M-24V-IP65-WW	Cálido	2700°K	15W/m	900lm/m	SMD 2835 - 320 led/m	2u.	1u.	242,18 USD	
NEON-360-5M-24V-IP65-NW	Neutro	4000°K	15W/m	900lm/m	SMD 2835 - 320 led/m	2u.	1u.	199,16 USD	
NEON-360-5M-24V-IP65-RGB	RGB	-	10W/m	310lm/m	SMD 2835 - 240 led/m	2u.	1u.	269,21 USD	
IVA 10,5%									

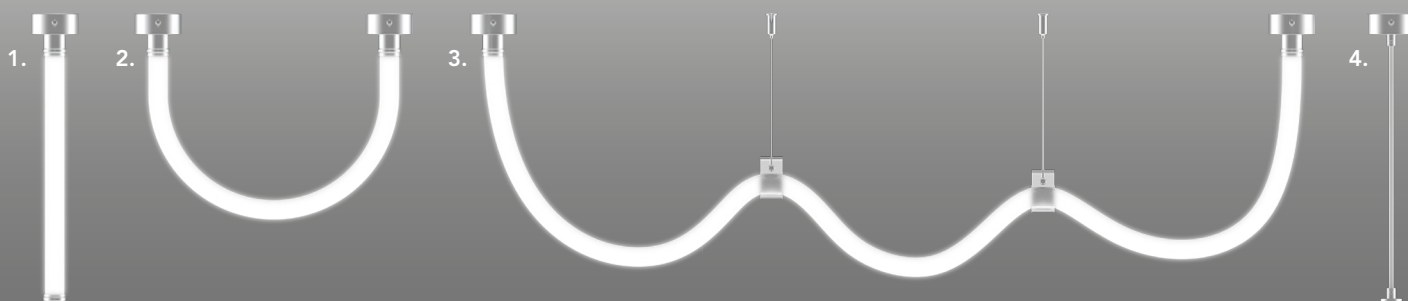

- 1. NEON-360-ACC6 / KIT DE ALUMINIO TIPO I PARA APLICAR DE 1M / NEON-360-1M
- 2. NEON-360-ACC3 / KIT DE ALUMINIO TIPO U PARA APLICAR / NEON-360-3M
- 3. NEON-360-ACC4 / KIT DE ALUMINIO PARA SUSPENSIÓN LIBRE / NEON-360-5M
- 4. NEON-360-ACC5 / KIT DE ALUMINIO TIPO I PARA SUSPENDER DE 1M / NEON-360-1M

Las simulaciones fueron hechas con distintos largos de tiras 360°

A- 350mm C- 1560mm
B- 620mm D- 280mm



KIT DE ALUMINIO TIPO I PARA APLICAR DE 1M		MASTER	VENTA MIN	PRECIO SIN IVA
NEON-360-ACC6	Contiene: 1 endcap de aluminio, 1 accesorio tubular acrílico (separado), 1 sujetador de aplicar, 1 puente, 8 tornillos sin cabeza (para fijar el tubo), 2 tornillos (del sujetador), 2 tornillos de pared, 2 tarugos y 1 destornillador.	50u.	1u.	22,15 USD
				IVA 21%



KIT DE ALUMINIO TIPO U PARA APLICAR		MASTER	VENTA MIN	PRECIO SIN IVA
NEON-360-ACC3	Contiene: 2 sujetadores de aplicar, 2 puentes, 8 tornillos sin cabeza (para fijar la tira), 4 tornillos (del sujetador), 4 tornillos de pared, 4 tarugos y 1 destornillador.	50u.	1u.	20,25 USD
				IVA 21%



KIT DE ALUMINIO PARA SUSPENSIÓN LIBRE		MASTER	VENTA MIN	PRECIO SIN IVA
NEON-360-ACC4	Contiene: 2 tensores de acero para suspensión, 2 sujetadores de aplicar, 2 puentes, 8 tornillos sin cabeza (para fijar la tira), 4 tornillos (del sujetador), 4 tornillos de pared, 4 tarugos y 1 destornillador.	50u.	1u.	38,62 USD
				IVA 21%



KIT DE ALUMINIO TIPO I PARA SUSPENDER DE 1M		MASTER	VENTA MIN	PRECIO SIN IVA
NEON-360-ACC5	Contiene: 2 endcaps de aluminio, 1 accesorio tubular acrílico (separado), 1 sujetador de suspensión, 1 puente, 8 tornillos sin cabeza (para fijar el tubo), 2 tornillos (del sujetador), 2 tornillos de pared, 2 tarugos y 1 destornillador.	1u.	50u.	27,87 USD
				IVA 21%

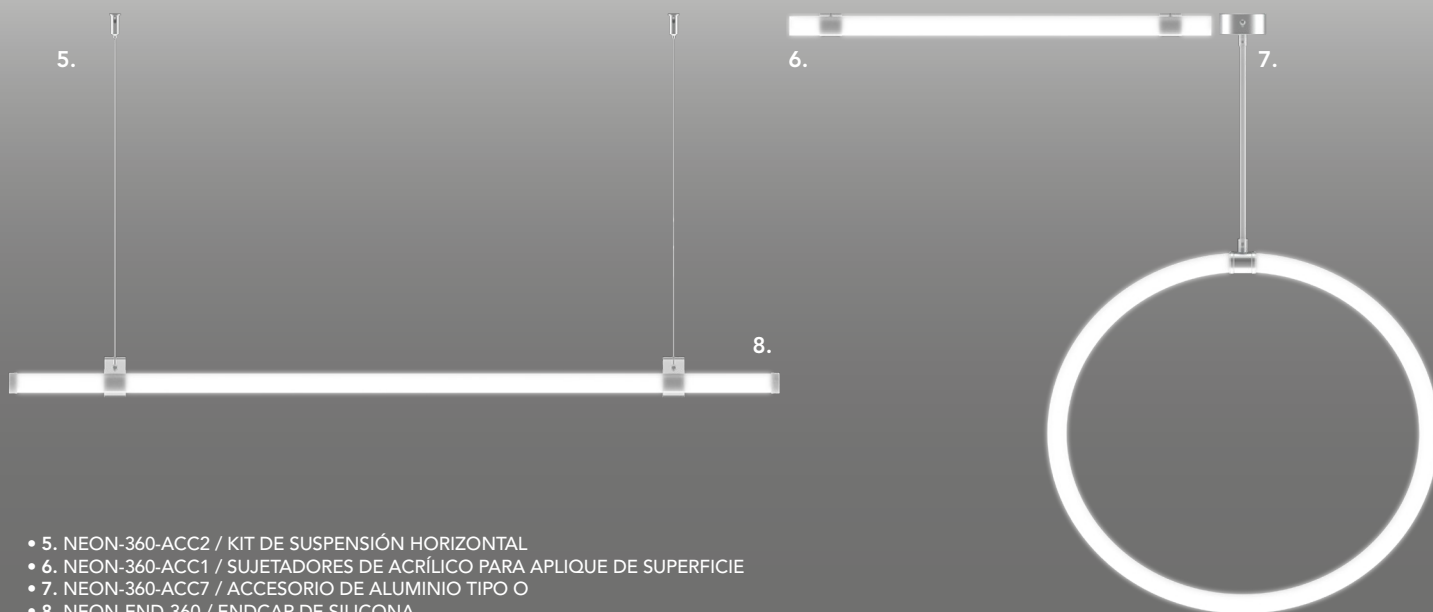

- 5. NEON-360-ACC2 / KIT DE SUSPENSIÓN HORIZONTAL
- 6. NEON-360-ACC1 / SUJETADORES DE ACRÍLICO PARA APLIQUE DE SUPERFICIE
- 7. NEON-360-ACC7 / ACCESORIO DE ALUMINIO TIPO O
- 8. NEON-END-360 / ENDCAP DE SILICONA



KIT DE SUSPENSIÓN HORIZONTAL		MASTER	VENTA MIN	PRECIO SIN IVA
NEON-360-ACC2	Contiene: 2 tensores de acero de 1m para suspensión, 2 tornillos de pared, 2 tarugos y 1 accesorio tubular acrílico (separado).	50u.	1u.	25,31 USD
				IVA 21%



ENDCAP DE SILICONA		MASTER	VENTA MIN	PRECIO SIN IVA
NEON-END-360	Contiene: 10 endcaps de silicona.	500u.	50u.	1,02 USD
				IVA 21%



SUJETADORES DE ACRÍLICO PARA APLIQUE DE SUPERFICIE		MASTER	VENTA MIN	PRECIO SIN IVA
NEON-360-ACC1	Contiene: 1 sujetador de acrílico para aplique de superficie.	250u.	10u.	2,34 USD
				IVA 21%



ACCESORIO DE ALUMINIO TIPO O		MASTER	VENTA MIN	PRECIO SIN IVA
NEON-360-ACC7	Contiene: 1 sujetador de suspensión, 1 accesorio tipo O, 1 puente, 8 tornillos sin cabeza (para fijar el tubo), 2 tornillos (del sujetador), 2 tornillos de pared, 2 tarugos y 1 destornillador.	100u.	1u.	13,68 USD
				IVA 21%



TIRA 2835 / 60 LED X METRO / IP20 / 12V / Ancho 8mm / Rollo de 5m					VIDA ÚTIL	MASTER	VENTA MIN	PRECIO SIN IVA
WW-C300-FW12-IP20	Cálido	2700°K	12WxM	1.030 lmxM	50000hs.	50u.	1u.	12,72 USD
CW-C300-FW12-IP20	Frío	6000°K	12WxM	1.080 lmxM	50000hs.	50u.	1u.	
R-C300-FW12-IP20	Rojo	625 NM	8WxM	180 lmxM	50000hs.	50u.	1u.	
G-C300-FW12-IP20	Verde	520 NM	8WxM	960 lmxM	50000hs.	50u.	1u.	
B-C300-FW12-IP20	Azul	460 NM	8WxM	120 lmxM	50000hs.	50u.	1u.	
Y-C300-FW12-IP20	Amarillo	585 NM	8WxM	180 lmxM	50000hs.	50u.	1u.	13,89 USD
								IVA 10,5%

TIRA 2835 / 60 LED X METRO / IP45 / 12V / Ancho 8mm / Rollo de 5m					VIDA ÚTIL	MASTER	VENTA MIN	PRECIO SIN IVA
WW-C300-FW12-IP45	Cálido	2700°K	12WxM	1.030 lmxM	50000hs.	50u.	1u.	15,43 USD
CW-C300-FW12-IP45	Frío	6000°K	12WxM	1.080 lmxM	50000hs.	50u.	1u.	
R-C300-FW12-IP45	Rojo	625 NM	8WxM	180 lmxM	50000hs.	50u.	1u.	
G-C300-FW12-IP45	Verde	520 NM	8WxM	960 lmxM	50000hs.	50u.	1u.	
B-C300-FW12-IP45	Azul	460 NM	8WxM	120 lmxM	50000hs.	50u.	1u.	
Y-C300-FW12-IP45	Amarillo	585 NM	8WxM	180 lmxM	50000hs.	50u.	1u.	15,43 USD
								IVA 10,5%

TIRA 2835 / 60 LED X METRO / IP66 / 12V / Ancho 8mm / Rollo de 5m					VIDA ÚTIL	MASTER	VENTA MIN	PRECIO SIN IVA
WW-C300-FW12-IP66	Cálido	2700°K	12WxM	1.030 lmxM	50000hs.	50u.	1u.	17,06 USD
CW-C300-FW12-IP66	Frío	6000°K	12WxM	1.080 lmxM	50000hs.	50u.	1u.	
R-C300-FW12-IP66	Rojo	625 NM	8WxM	180 lmxM	50000hs.	50u.	1u.	
G-C300-FW12-IP66	Verde	520 NM	8WxM	960 lmxM	50000hs.	50u.	1u.	
B-C300-FW12-IP66	Azul	460 NM	8WxM	120 lmxM	50000hs.	50u.	1u.	
Y-C300-FW12-IP66	Amarillo	585 NM	8WxM	180 lmxM	50000hs.	50u.	1u.	17,06 USD
								IVA 10,5%

TIRA 2835 / 120 LED X METRO / IP20 / 12V / Ancho 8mm / Rollo de 5m					VIDA ÚTIL	MASTER	VENTA MIN	PRECIO SIN IVA
WW-C600-FW12-IP20	Cálido	2700°K	16WxM	1.860 lmxM	50000hs.	50u.	1u.	14,34 USD
CW-C600-FW12-IP20	Frío	6000°K	16WxM	1.860 lmxM	50000hs.	50u.	1u.	
								IVA 10,5%

TIRA 2835 / 120 LED X METRO / IP20 / 24V / Ancho 8mm / Rollo de 5m					VIDA ÚTIL	MASTER	VENTA MIN	PRECIO SIN IVA
WW-C600-FW24-IP20	Cálido	2700°K	16WxM	1.860 lmxM	50000hs.	50u.	1u.	14,34 USD
CW-C600-FW24-IP20	Frío	6000°K	16WxM	1.860 lmxM	50000hs.	50u.	1u.	
								IVA 10,5%

TIRA 2216 / 300 LED X METRO / IP20 / 24V / Ancho 10mm / Rollo de 5m					VIDA ÚTIL	MASTER	VENTA MIN	PRECIO SIN IVA
WW-D1500-FW24-IP20	Cálido	2700°K	18WxM	1.600 lmxM	50000hs.	50u.	1u.	35,55 USD
								IVA 10,5%



TIRA 5050 / 60 LED X METRO / IP20 / 12V / Ancho 10mm / Rollo de 5m					VIDA ÚTIL	MASTER	VENTA MIN	PRECIO SIN IVA
WW-B300-FW12-IP20	Cálido	2700°K	14.4WxM	1.425 lmxM	50000hs.	50u.	1u.	16,67 USD
NW-B300-FW12-IP20	Neutro	4500°K	14.4WxM	1.450 lmxM	50000hs.	50u.	1u.	
CW-B300-FW12-IP20	Frío	6500°K	14.4WxM	1.500 lmxM	50000hs.	50u.	1u.	
R-B300-FW12-IP20	Rojo	625 NM	14.4WxM	360 lmxM	50000hs.	50u.	1u.	
G-B300-FW12-IP20	Verde	520 NM	14.4WxM	1.140 lmxM	50000hs.	50u.	1u.	
B-B300-FW12-IP20	Azul	460 NM	14.4WxM	300 lmxM	50000hs.	50u.	1u.	
Y-B300-FW12-IP20	Amarillo	585 NM	14.4WxM	1.020 lmxM	50000hs.	50u.	1u.	
AW-B300-FW12-IP20	Ambar	2200K	14.4WxM	1.020 lmxM	50000hs.	50u.	1u.	
RGB-B300-FW12-IP20	RGB	-	-	Variable	50000hs.	50u.	1u.	19,08 USD
								IVA 10,5%

TIRA 5050 / 60 LED X METRO / IP20 / 24V / Ancho 10mm / Rollo de 5m					VIDA ÚTIL	MASTER	VENTA MIN	PRECIO SIN IVA
WW-B300-FW24-IP20	Cálido	2700°K	14.4WxM	1.425 lmxM	50000hs.	50u.	1u.	16,67 USD
CW-B300-FW24-IP20	Frío	6000°K	14.4WxM	1.500 lmxM	50000hs.	50u.	1u.	IVA 10,5%

TIRA 5050 / 60 LED X METRO / IP45 / 12V / Rollo de 5m					VIDA ÚTIL	MASTER	VENTA MIN	PRECIO SIN IVA
WW-B300-FW12-IP45	Cálido	2700°K	14.4WxM	1.425 lmxM	50000hs.	50u.	1u.	19,22 USD
CW-B300-FW12-IP45	Frío	6000°K	14.4WxM	1.500 lmxM	50000hs.	50u.	1u.	
R-B300-FW12-IP45	Rojo	625 NM	14.4WxM	360 lmxM	50000hs.	50u.	1u.	
G-B300-FW12-IP45	Verde	520 NM	14.4WxM	1.140 lmxM	50000hs.	50u.	1u.	
B-B300-FW12-IP45	Azul	460 NM	14.4WxM	300 lmxM	50000hs.	50u.	1u.	
Y-B300-FW12-IP45	Amarillo	585 NM	14.4WxM	1.020 lmxM	50000hs.	50u.	1u.	
RGB-B300-FW12-IP45	RGB	-	-	Variable	50000hs.	50u.	1u.	21,64 USD
								IVA 10,5%

TIRA 5050 / 60 LED X METRO / IP66 / 12V / Ancho 10mm / Rollo de 5m					VIDA ÚTIL	MASTER	VENTA MIN	PRECIO SIN IVA
WW-B300-FW12-IP66	Cálido	2700°K	14.4WxM	1.425 lmxM	50000hs.	50u.	1u.	23,70 USD
CW-B300-FW12-IP66	Frío	6000°K	14.4WxM	1.500 lmxM	50000hs.	50u.	1u.	
R-B300-FW12-IP66	Rojo	625 NM	14.4WxM	360 lmxM	50000hs.	50u.	1u.	
G-B300-FW12-IP66	Verde	520 NM	14.4WxM	1.140 lmxM	50000hs.	50u.	1u.	
B-B300-FW12-IP66	Azul	460 NM	14.4WxM	300 lmxM	50000hs.	50u.	1u.	
Y-B300-FW12-IP66	Amarillo	585 NM	14.4WxM	1.020 lmxM	50000hs.	50u.	1u.	
RGB-B300-FW12-IP66	RGB	-	-	Variable	50000hs.	50u.	1u.	26,11 USD
								IVA 10,5%

TIRA 5050 / 60 LED X METRO / IP66 / 24V / Ancho 10mm / Rollo de 5m					VIDA ÚTIL	MASTER	VENTA MIN	PRECIO SIN IVA
WW-B300-FW24-IP66	Cálido	3000°K	14.4WxM	1.500 lmxM	50000hs.	50u.	1u.	23,70 USD
CW-B300-FW24-IP66	Frío	6000°K	14.4WxM	1.500 lmxM	50000hs.	50u.	1u.	IVA 10,5%



CONECTOR 5050 SIMPLE		PINES	TAMAÑO	CABLE	MASTER	PRECIO SIN IVA
ELL-A2P-10-5050	Normal	2	10mm	0,5x150mm	100u.	0,77 USD
ELL-E2P-RGB	RGB	4	10mm	0,5x150mm	100u.	0,99 USD IVA 21%



CONECTOR 2835 / 3528 SIMPLE		PINES	TAMAÑO	CABLE	MASTER	PRECIO SIN IVA
ELL-A2P-8-3528	Normal	2	8mm	0,5x150mm	100u.	0,71 USD IVA 21%



CONECTOR 5050 DOBLE		PINES	TAMAÑO	CABLE	MASTER	PRECIO SIN IVA
ELL-C2P-10-5050	Normal	2	10mm	0,5x150mm	100u.	1,11 USD
ELL-D2P-RGB	RGB	4	10mm	0,5x150mm	100u.	1,22 USD IVA 21%



CONECTOR 2835 / 3528 DOBLE		PINES	TAMAÑO	CABLE	MASTER	PRECIO SIN IVA
ELL-C2P-8-3528	Normal	2	8mm	0,5x150mm	100u.	1,05 USD IVA 21%



CONECTOR 5050 SIN CABLE		PINES	TAMAÑO	CABLE	MASTER	PRECIO SIN IVA
ELL-B2P-10-5050	-	-	10mm	-	100u.	0,69 USD IVA 21%



CONECTOR 2835/3528 SIN CABLE		PINES	TAMAÑO	CABLE	MASTER	PRECIO SIN IVA
ELL-B2P-8-3528	-	-	8mm	-	100u.	0,69 USD IVA 21%



Control incluido
16 funciones



Control incluido
16 funciones

Apta para
BLANCOS DINÁMICOS



CONTROLADORA RGB+W SMART WIFI / 20mts	PWR MÁX (12V)	PWR MÁX (24V)	TAMAÑO	MASTER	VENTA MIN	PRECIO SIN IVA
CON-RGBW-WIFI-6ACH	12V-24V	150W	300W	85x45x23mm	100u.	1u.
						46,10 USD
						IVA 21%



CONTROLADORA CCT SMART WIFI / 20mts	PWR MÁX (12V)	PWR MÁX (24V)	TAMAÑO	MASTER	VENTA MIN	PRECIO SIN IVA
CON-CCT-WIFI-6ACH	12V-24V	144W	288W	85x45x23mm	100u.	1u.
						24,70 USD
						IVA 21%



Apta para
BLANCOS DINÁMICOS



Control incluido
16 funciones



Control incluido
16 funciones



CONTROLADORA CCT / 20mts	PWR MÁX (12V)	PWR MÁX (24V)	TAMAÑO	MASTER	VENTA MIN	PRECIO SIN IVA
CON-CCT-IR-3ACH	12V-24V	72W	144W	86x40x6mm	100u.	1u.
						7,20 USD
						IVA 21%



CONTROLADORA RGB+W / 30mts	PWR MÁX (12V)	PWR MÁX (24V)	TAMAÑO	MASTER	VENTA MIN	PRECIO SIN IVA
CON-RGBW-RF-288W	12V-24V	288W	576W	110x55x20mm	100u.	1u.
						32,50 USD
						IVA 21%



CONTROLADOR INFLAROJO / 5mts	MATERIAL	TAMAÑO	MASTER	VENTA MIN	PRECIO SIN IVA
CON-RGB-IR-72W	Plástico	61x35x22mm	200u	1u.	6,00 USD IVA 21%



CONTROLADOR RADIOFRECUENCIA / 10mts	MATERIAL	TAMAÑO	MASTER	MASTER	PRECIO SIN IVA
CON-RGB-RF-144W	Metal	130x65x25mm	100u.	1u.	20,80 USD IVA 21%



C. RADIOFRECUENCIA (C/ CONTROL) / 10mts	MATERIAL	TAMAÑO	MASTER	VENTA MIN	PRECIO SIN IVA
CON-RGB-RF-360W	Metal	121x75x25mm	100u.	1u.	24,37 USD IVA 21%



CONTROLADORA SMART 144W	PWR MÁX (12V)	PWR MÁX (24V)	TAMAÑO	MASTER	PRECIO SIN IVA
CON-WIFI-IR-144W	12V-24V	144W	288W	100u. 1u.	17,91 USD IVA 21%



DIMMER REMOTO	MATERIAL	TAMAÑO	MASTER	VENTA MIN	PRECIO SIN IVA
DIM-IR-96W	Plástico	87x87x53mm	84u.	1u.	15,02 USD IVA 21%



AMPLIFICADOR / 10mts	MATERIAL	TAMAÑO	MASTER	VENTA MIN	PRECIO SIN IVA
AMP-RGB-12A	Metal	105x65x23mm	120u.	1u.	11,07 USD IVA 21%



MATERIAL
METAL

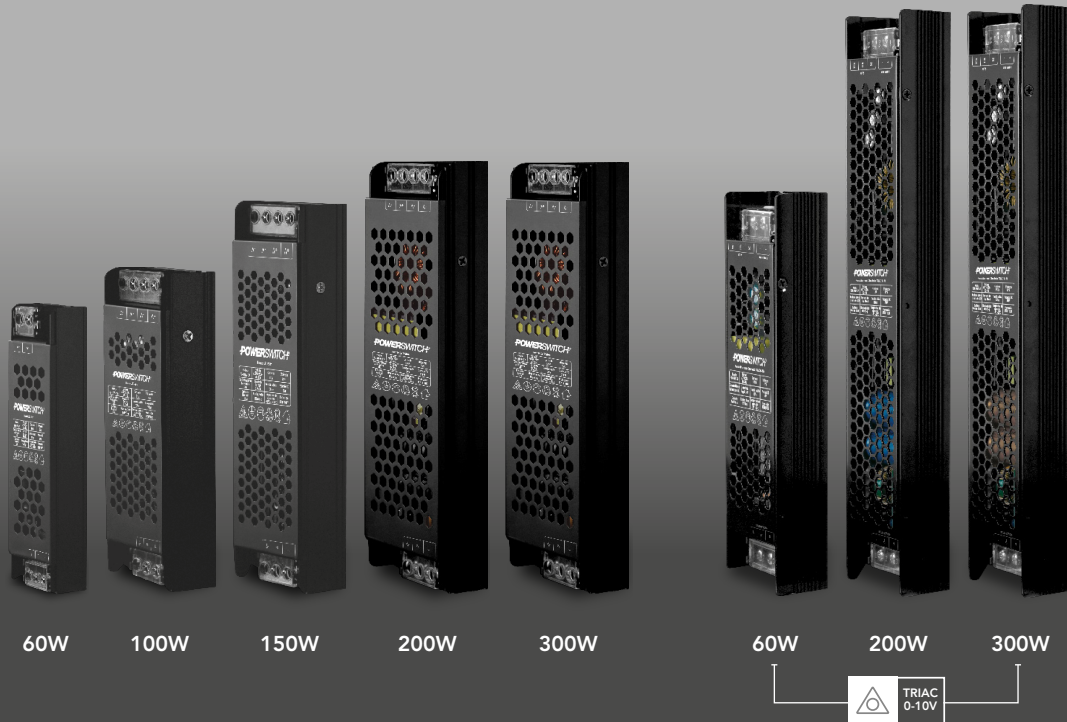

FUENTE LED SLIM	(W-A)	ENTRADA	SALIDA	MASTER	VENTA MIN	PRECIO SIN IVA
FS-60W-12V	60W-5A	170-260V	12V	96u	1u	15,30 USD
FS-100W-12V	100W-8.3A	170-260V	12V	70u	1u	18,50 USD
FS-150W-12V	150W-12.5A	170-260V	12V	70u	1u	26,00 USD
FS-200W-12V	200W-16.7A	170-260V	12V	40u	1u	35,00 USD
FS-300W-12V	300W-25A	170-260V	12V	40u	1u	42,00 USD
						IVA 21%



FUENTE LED SLIM	(W-A)	ENTRADA	SALIDA	MASTER	VENTA MIN	PRECIO SIN IVA
FS-60W-24V	60W-2.5A	170-260V	24V	96u	1u	15,30 USD
FS-100W-24V	100W-4.2A	170-260V	24V	70u	1u	18,50 USD
FS-150W-24V	150W-6.25A	170-260V	24V	70u	1u	26,00 USD
FS-200W-24V	200W-8.3A	170-260V	24V	40u	1u	35,00 USD
FS-300W-24V	300W-12.5A	170-260V	24V	40u	1u	42,00 USD
						IVA 21%



FUENTE LED SLIM DIMERIZABLE	(W-A)	ENTRADA	SALIDA	MASTER	VENTA MIN	PRECIO SIN IVA
FSD-60W-12V	60W-5A	170-264V	12V	96u	1u	45,00 USD
FSD-200W-12V	200W-16.7A	170-264V	12V	30u	1u	85,00 USD
FSD-300W-12V	300W-25A	170-264V	12V	30u	1u	130,00 USD
						IVA 21%



FUENTE LED SLIM DIMERIZABLE	(W-A)	ENTRADA	SALIDA	MASTER	VENTA MIN	PRECIO SIN IVA
FSD-60W-24V	60W-2.5A	170-264V	24V	96u	1u	45,00 USD
FSD-200W-24V	200W-8.3A	170-264V	24V	30u	1u	85,00 USD
FSD-300W-24V	300W-25A	170-264V	24V	30u	1u	130,00 USD
						IVA 21%

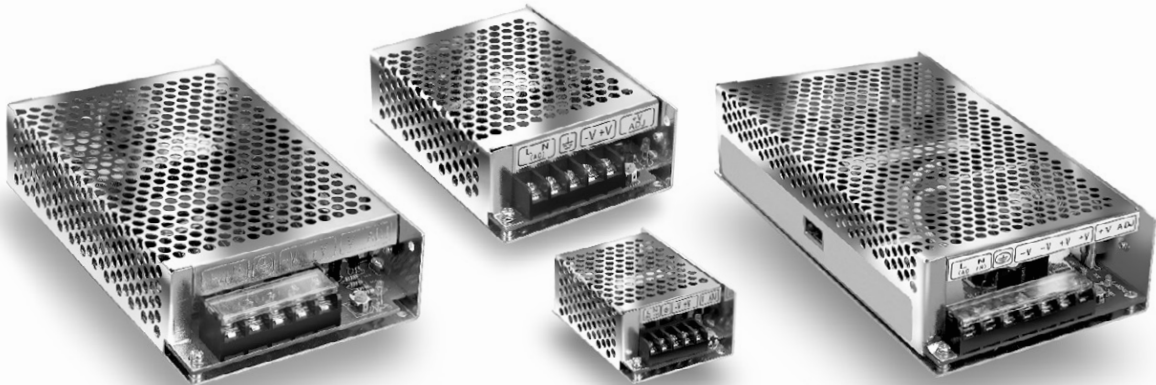

DRIVER INTERIOR	MATERIAL	(W-A)	ENTRADA	SALIDA	MASTER	VENTA MIN	PRECIO SIN IVA
PD-12W-12V	Plástico	12W - 1A	100-240V	12V	360u.	1u.	9,44 USD
PD-25W-12V	Plástico	25W - 2.1A	100-240V	12V	256u.	1u.	12,32 USD
							IVA 21%



DRIVER INTERIOR	MATERIAL	(W-A)	ENTRADA	SALIDA	MASTER	VENTA MIN	PRECIO SIN IVA
PD-12W-24V	Plástico	12W - 0.5A	100-240V	24V	360u.	1u.	9,44 USD
PD-25W-24V	Plástico	25W - 1A	100-240V	24V	256u.	1u.	12,32 USD
							IVA 21%



FUENTE INTERIOR 12V	MATERIAL	(W-A)	ENTRADA	SALIDA	MASTER	VENTA MIN	PRECIO SIN IVA
S-25W-12V	Metal	25W-2.1A	100-240V	12V	100u	1u.	14,48 USD
S-35W-12V	Metal	35W-3A	100-240V	12V	100u	1u.	15,36 USD
S-50W-12V	Metal	50W-4A	100-240V	12V	80u	1u.	19,99 USD
S-60W-12V	Metal	60W-5A	100-240V	12V	80u	1u.	20,45 USD
S-75W-12V	Metal	75W-6A	100-240V	12V	40u	1u.	23,22 USD
S-100W-12V	Metal	100W-8A	100-240V	12V	30u	1u.	28,04 USD
S-120W-12V	Metal	120W-10A	100-240V	12V	30u	1u.	28,59 USD
S-150W-12V	Metal	150W-12A	100-240V	12V	24u	1u.	40,03 USD
S-201W-12V	Metal	201W-17A	100-240V	12V	20u	1u.	50,16 USD
S-350W-12V	Metal	350W-29A	100-240V	12V	20u	1u.	56,60 USD
							IVA 21%



FUENTE INTERIOR 24V	MATERIAL	(W-A)	ENTRADA	SALIDA	MASTER	VENTA MIN	PRECIO SIN IVA
S-25W-24V	Metal	25W-1A	100-240V	24V	100u	1u.	14,48 USD
S-35W-24V	Metal	35W-1,5A	100-240V	24V	100u	1u.	15,36 USD
S-50W-24V	Metal	50W-2A	100-240V	24V	80u	1u.	19,99 USD
S-60W-24V	Metal	60W-2.5A	100-240V	24V	80u	1u.	20,45 USD
S-75W-24V	Metal	75W-3A	100-240V	24V	40u	1u.	23,22 USD
S-100W-24V	Metal	100W-4.1A	100-240V	24V	30u	1u.	28,04 USD
S-120W-24V	Metal	120W-5A	100-240V	24V	30u	1u.	28,59 USD
S-150W-24V	Metal	150W-6.25A	100-240V	24V	24u	1u.	40,03 USD
S-201W-24V	Metal	201W-8,5A	100-240V	24V	20u	1u.	50,16 USD
S-350W-24V	Metal	350W-14,5A	100-240V	24V	20u	1u.	56,60 USD
							IVA 21%



FUENTE EXTERIOR 12V	MATERIAL	(W-A)	ENTRADA	SALIDA	MASTER	VENTA MIN	PRECIO SIN IVA
BG-30W-12V	Metal	30W-2.5A	100-240V	12V	100u	1u	19,75 USD
BG-60W-12V	Metal	60W-5A	100-240V	12V	32u	1u	34,15 USD
BG-100W-12V	Metal	100W-8A	100-240V	12V	21u	1u	49,04 USD
BG-150W-12V	Metal	150W-12.5A	100-240V	12V	16u	1u	77,86 USD
							IVA 21%

FUENTE EXTERIOR 24V	MATERIAL	(W-A)	ENTRADA	SALIDA	MASTER	VENTA MIN	PRECIO SIN IVA
BG-30W-24V	Metal	30W-8A	100-240V	24V	100u	1u	19,75 USD
BG-60W-24V	Metal	60W-2.5A	100-240V	24V	32u	1u	34,15 USD
BG-100W-24V	Metal	100W-2.5A	100-240V	24V	21u	1u	49,04 USD
BG-150W-24V	Metal	150W-6.2A	100-240V	24V	16u	1u	71,57 USD
							IVA 21%

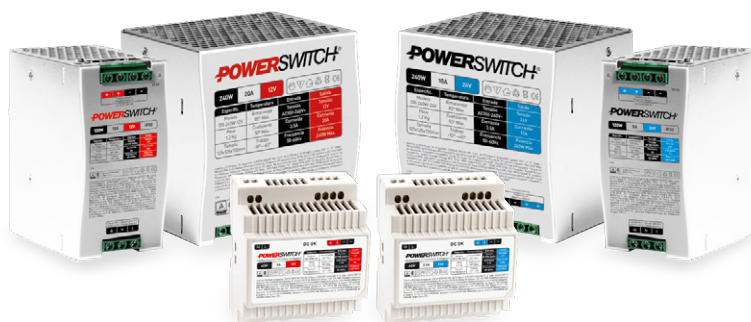

FUENTE INTERIOR 12V (RIEL DIN)		(W-A)	ENTRADA	SALIDA	MASTER	VENTA MIN.	PRECIO SIN IVA
DR-60W-12V	Plástico	60W - 5A	100-240V	12V	50u.	1u.	36,36 USD
DR-120W-12V	Metal	120W - 10A	100-240V	12V	20u.	1u.	72,89 USD
DR-240W-12V	Metal	240W - 20A	100-240V	12V	12u.	1u.	145,73 USD
							IVA 21%

FUENTE INTERIOR 24V (RIEL DIN)		(W-A)	ENTRADA	SALIDA	MASTER	VENTA MIN	PRECIO SIN IVA
DR-60W-24V	Plástico	60W - 2,5A	100-240V	24V	50u.	1u.	36,36 USD
DR-120W-24V	Metal	120W - 5A	100-240V	24V	20u.	1u.	72,89 USD
DR-240W-24V	Metal	240W - 10A	100-240V	24V	12u.	1u.	145,73 USD
							IVA 21%



BATERÍAS ALCALINAS	TIPO	IEC	*VIDA ÚTIL	MASTER	VENTA MIN	PRECIO SIN IVA
PS-LR6-AA-P4	AA	LR6	10 años	160u	20u	1,26 USD
PS-LR6-AA-P2	AA	LR6	10 años	160u	20u	0,71 USD
PS-LR03-AAA-P4	AAA	LR03	10 años	240u	30u	1,61 USD
PS-LR03-AAA-P2	AAA	LR03	10 años	240u	30u	0,90 USD
PS-6LR61-9V-P1	9V	6LR61	7 años	240u	30u	1,70 USD
PS-LR20-D-P2	D	LR20	10 años	48u	12u	3,76 USD
PS-LR14-C-P2	C	LR14	10 años	96u	12u	2,61 USD

IVA 21%

*Conserva su energía hasta los años indicados en almacenamiento (sin uso).



BATERÍAS DE LITIO	TIPO	TENSIÓN	* VIDA ÚTIL	MASTER	VENTA MIN	PRECIO SIN IVA
PS-LI-CR2016-P5	CR2016	3V	5 años	200u	20u	1,23 USD
PS-LI-CR2025-P5	CR2025	3V	5 años	200u	20u	1,23 USD
PS-LI-CR2032-P5	CR2032	3V	5 años	200u	20u	1,23 USD
PS-LI-CR2450-P5	CR2450	3V	5 años	200u	20u	3,41 USD

IVA 21%

*Conserva su energía hasta los años indicados en almacenamiento (sin uso).



Importa y distribuye

Derecho de Imagen y Representación

Todo el contenido visual (imágenes, fotografías, logotipos, etc.) de nuestras marcas Macroled, PowerSwitch e Inteck y por consecuente de la marca CHINT y Astronergy donde actuamos como representante oficial en el país son propiedad intelectual pertenecientes a Coresa Group SRL, queda terminantemente prohibido el uso inadecuado o la reproducción de contenido sin autorización escrita por parte de la empresa. En caso de poseer dicha autorización, el contenido visual utilizado deberá estar acompañado por nuestra marca madre Coresa Group y/o por la siguiente descripción: "Propiedad Intelectual de Coresa Group SRL todos los derechos Reservados". O una marca del grupo Coresa.

CUENTA BANCARIA

Titular: Coresa Group SRL

CUIT: 30-71178446-9



CBU: 0720762620000002861618

Cuenta Cte: 762-028616/1

Sucursal: Pellegrini (018/6)

GERENCIA COMERCIAL

Dirección: Laminar Plaza: Ingeniero Butty 240, piso 10.

Tel: 0810-222-2882

Interno ---

GERENTE LOGÍSTICO

Contacto: Santiago Osorio

0810 222 2882

Interno 103

santiago.osorio@coresagroup.com.ar

Centro Logístico 3 de Febrero - Grupo Posadas. Km 10, Au Cam. del Buen Ayre, 1678 Buenos Aires

HORARIOS DE ATENCIÓN Lunes a Viernes de 9:00 a 18:00 hs

DESCUENTO	TODA LA LISTA	MACROLED	RESTO	CHINT	UNIVIEW
 % % % % %
Forma de pago	LC=US0 : LC + LCC				
Envios sin cargo desde: USD.				
Facturación \$ (TIPO DE CAMBIO BNA - BANCO NACIÓN ARGENTINA)					
Garantías: Macroled General 2 años, Macroled Alta Potencia 5 años, PowerSwitch 2 años CHINT 3 años, CHINT Power 5 años, Astronergy 10 Años MACROLED, 1, 2, LÍNEA PRO 3 O LÍNEA ALTA POTENCIA 5 AÑOS, CHINT 3 AÑOS, UNV 1, 2 AÑOS					
Capacitaciones Técnicas y Comerciales.				
Acciones de Marketing en punto de Venta.				
Observaciones.				