

SKYLINE MACROLED®

LISTA DE ARQUITECTOS
MARZO 2026

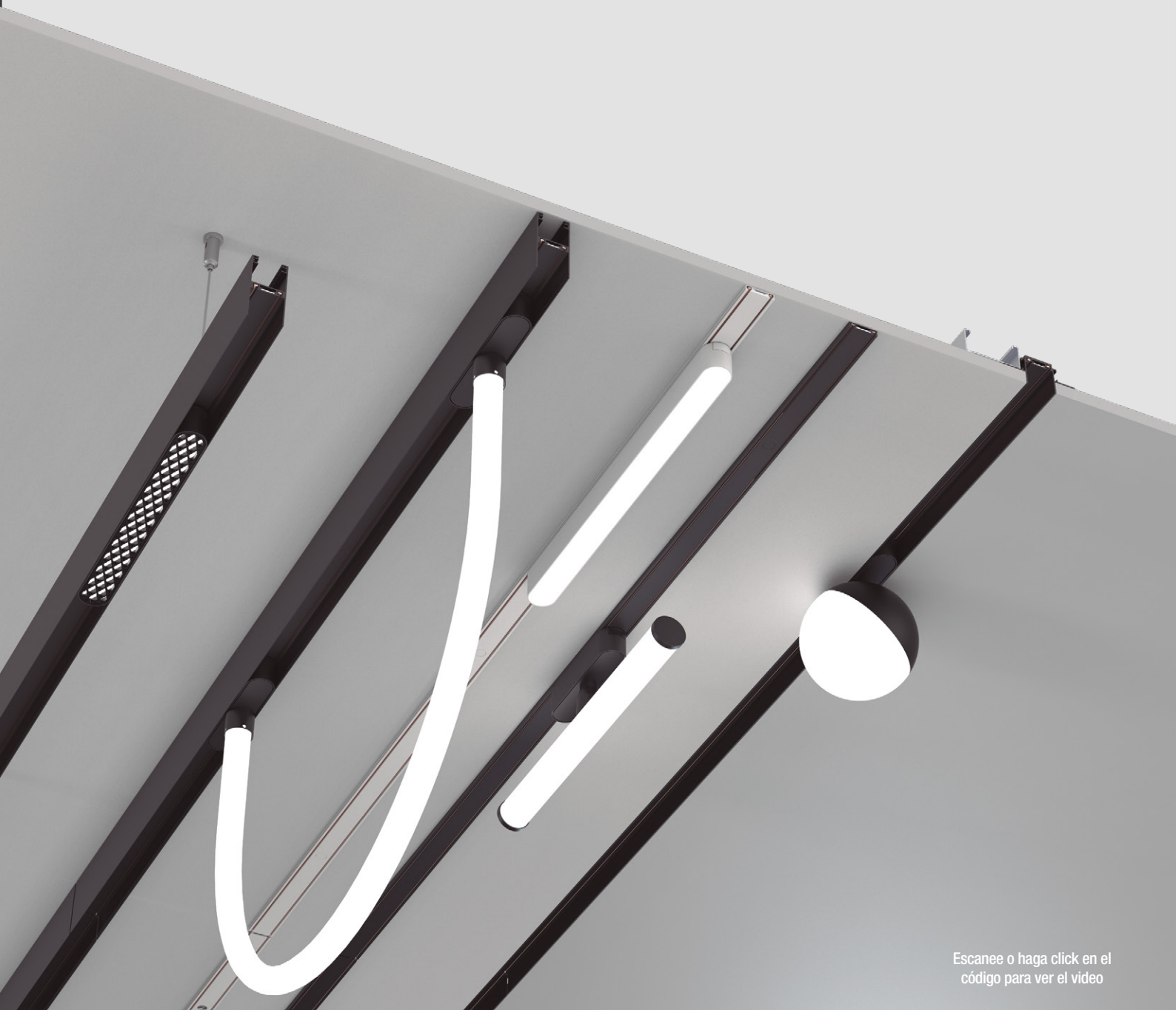

Escanee o haga click en el
código para ver el video

Apliques



Difuso

Focal

Panal



Dimerizable con fuente

ACCESORIO MÓVIL

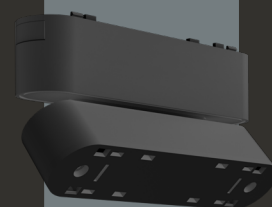

Adiciona un eje de rotación de 90° a tus cabezales de 11 y 22cm

CABEZAL DIFUSO	ÁNGULO	TEMPCOLOR	LARGO	POTENCIA	LÚMENES	MASTER	VENTA MIN.
RMS-CD114-N-6W-WW	Difuso 90°	Blanco Cálido 2700K	11cm	6W	240lm	50u.	1u.
RMS-CD222-N-12W-WW			22cm	12W	500lm	50u.	1u.
RMS-CD330-N-16W-WW			33cm	16W	640lm	50u.	1u.

CABEZAL FOCAL	ÁNGULO	TEMPCOLOR	LARGO	POTENCIA	LÚMENES	MASTER	VENTA MIN.
RMS-CF114-N-6W-WW	Focal 36°	Blanco Cálido 2700K	11cm	6W	390lm	50u.	1u.
RMS-CF222-N-12W-WW			22cm	12W	880lm	50u.	1u.
RMS-CF330-N-16W-WW			33cm	16W	1040lm	50u.	1u.

CABEZAL PANAL	ÁNGULO	TEMPCOLOR	LARGO	POTENCIA	LÚMENES	MASTER	VENTA MIN.
RMS-CP114-N-6W-WW	Panal 60°	Blanco Cálido 2700K	11cm	6W	70lm	50u.	1u.
RMS-CP222-N-12W-WW			22cm	12W	160lm	50u.	1u.
RMS-CP330-N-16W-WW			33cm	16W	210lm	50u.	1u.

MÓDULOS MÓVILES PARA CABEZALES	DIMENSIONES	LÚMENES	MASTER	INTERMEDIA	VENTA MIN.
RMS-MM-N-6W	11cm	6W	50u.	12u.	1u.
RMS-MM-N-12W	22cm	12W	50u.	12u.	1u.

Apliques

SMART

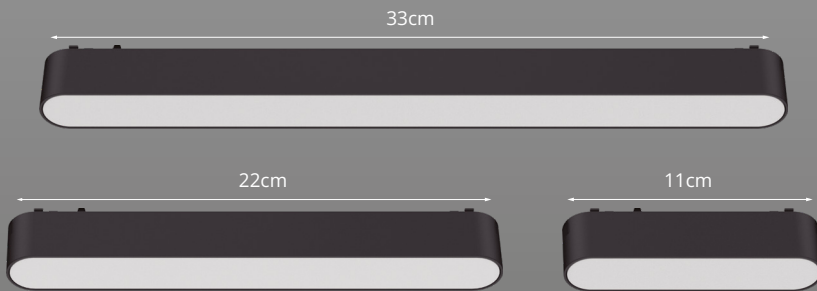

ACCESORIO MÓVIL

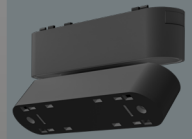

Adiciona un eje de rotación de 90° a tus cabezales de 11 y 22cm

Difuso

Focal

Panel



Dimerizable con App

2000K -5000K



Cambio de Temperatura con App



DISPONIBLE EN Google Play

Consíguelo en el App Store

CABEZAL DIFUSO	ÁNGULO	TEMPCOLOR	LARGO	POTENCIA	LÚMENES	MASTER	VENTA MIN.
RMS-S-CD114-N-6W	Difuso 90°	2000K-5000K	11cm	6W	240lm	50u.	1u.
RMS-S-CD222-N-12W			22cm	12W	500lm	50u.	1u.
RMS-S-CD330-N-16W			33cm	16W	640lm	50u.	1u.

CABEZAL FOCAL	ÁNGULO	TEMPCOLOR	LARGO	POTENCIA	LÚMENES	MASTER	VENTA MIN.
RMS-S-CF114-N-6W	Focal 36°	2000K-5000K	11cm	6W	390lm	50u.	1u.
RMS-S-CF222-N-12W			22cm	12W	880lm	50u.	1u.
RMS-S-CF330-N-16W			33cm	16W	1040lm	50u.	1u.

CABEZAL PANEL	ÁNGULO	TEMPCOLOR	LARGO	POTENCIA	LÚMENES	MASTER	VENTA MIN.
RMS-S-CP114-N-6W	Panel 60°	2000K-5000K	11cm	6W	70lm	50u.	1u.
RMS-S-CP222-N-12W			22cm	12W	160lm	50u.	1u.
RMS-S-CP330-N-16W			33cm	16W	210lm	50u.	1u.

MÓDULOS MÓVILES PARA CABEZALES	DIMENSIONES	LÚMENES	MASTER	INTERMEDIA	VENTA MIN.
RMS-MM-N-6W	11cm	6W	50u.	12u.	1u.
RMS-MM-N-12W	22cm	12W	50u.	12u.	1u.

Apliques

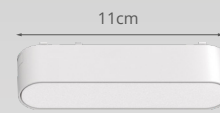
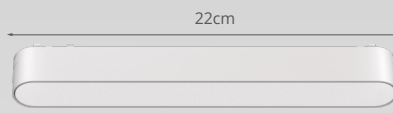
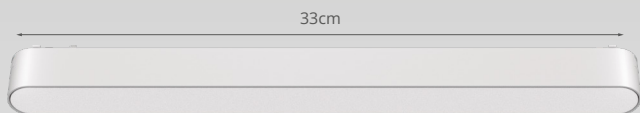

Difuso

Focal

Panel



Dimerizable
con fuente

ACCESORIO MÓVIL

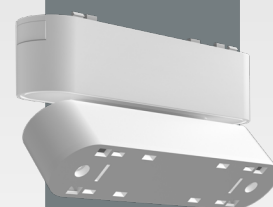

Adicioná un eje de rotación
de 90° a tus cabezales de
11 y 22cm

CABEZAL DIFUSO	ÁNGULO	TEMPCOLOR	LARGO	POTENCIA	LÚMENES	MASTER	VENTA MIN.
RMS-CD114-B-6W-WW	Difuso 90°	Blanco Cálido 2700K	11cm	6W	240lm	50u.	1u.
RMS-CD222-B-12W-WW			22cm	12W	500lm	50u.	1u.
RMS-CD330-B-16W-WW			33cm	16W	640lm	50u.	1u.

CABEZAL FOCAL	ÁNGULO	TEMPCOLOR	LARGO	POTENCIA	LÚMENES	MASTER	VENTA MIN.
RMS-CF114-B-6W-WW	Focal 36°	Blanco Cálido 2700K	11cm	6W	390lm	50u.	1u.
RMS-CF222-B-12W-WW			22cm	12W	880lm	50u.	1u.
RMS-CF330-B-16W-WW			33cm	16W	1040lm	50u.	1u.

CABEZAL PANAL	ÁNGULO	TEMPCOLOR	LARGO	POTENCIA	LÚMENES	MASTER	VENTA MIN.
RMS-CP114-B-6W-WW	Panal 60°	Blanco Cálido 2700K	11cm	6W	70lm	50u.	1u.
RMS-CP222-B-12W-WW			22cm	12W	160lm	50u.	1u.
RMS-CP330-B-16W-WW			33cm	16W	210lm	50u.	1u.

MÓDULOS MÓVILES PARA CABEZALES	LARGO	POTENCIA	MASTER	INTERMEDIA	VENTA MIN.
RMS-MM-B-6W	11cm	6W	50u.	12u.	1u.
RMS-MM-B-12W	22cm	12W	50u.	12u.	1u.

Apliques

SMART

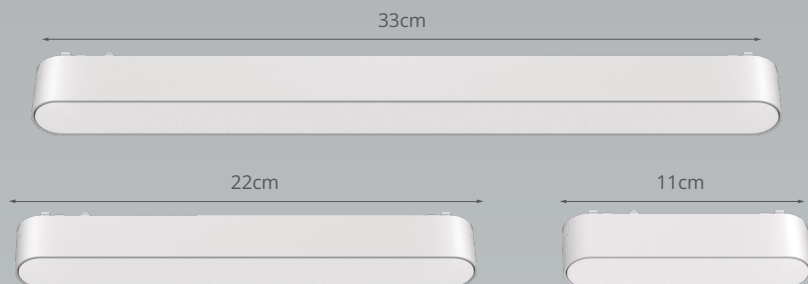

ACCESORIO MÓVIL



Adiciona un eje de rotación de 90° a tus cabezales de 11 y 22cm

Difuso

Focal

Panal



Dimerizable con App



Cambio de Temperatura con App



DISPONIBLE EN Google Play

Consíguelo en el App Store

CABEZAL DIFUSO	ÁNGULO	TEMPCOLOR	LARGO	POTENCIA	LÚMENES	MASTER	VENTA MIN.
RMS-S-CD114-B-6W	Difuso 90°	2000K-5000K	11cm	6W	240lm	50u.	1u.
RMS-S-CD222-B-12W			22cm	12W	500lm	50u.	1u.
RMS-S-CD330-B-16W			33cm	16W	640lm	50u.	1u.

CABEZAL FOCAL	ÁNGULO	TEMPCOLOR	LARGO	POTENCIA	LÚMENES	MASTER	VENTA MIN.
RMS-S-CF114-B-6W	Focal 36°	2000K-5000K	11cm	6W	390lm	50u.	1u.
RMS-S-CF222-B-12W			22cm	12W	880lm	50u.	1u.
RMS-S-CF330-B-16W			33cm	16W	1040lm	50u.	1u.

CABEZAL PANAL	ÁNGULO	TEMPCOLOR	LARGO	POTENCIA	LÚMENES	MASTER	VENTA MIN.
RMS-S-CP114-B-6W	Panal 60°	2000K-5000K	11cm	6W	70lm	50u.	1u.
RMS-S-CP222-B-12W			22cm	12W	160lm	50u.	1u.
RMS-S-CP330-B-16W			33cm	16W	210lm	50u.	1u.

MÓDULOS MÓVILES PARA CABEZALES	LARGO	POTENCIA	MASTER	INTERMEDIA	VENTA MIN.
RMS-MM-B-6W	11cm	6W	50u.	12u.	1u.
RMS-MM-B-12W	22cm	12W	50u.	12u.	1u.



SPOT MÓVIL			TEMPCOLOR	MODELO	ÁNGULO	MASTER	VENTA MIN.
Simple 5W	9cm	275lm	Blanco Cálido 2700K	RMS-CM-N-5W-15G-WW	15°	30u.	1u.
				RMS-CM-N-5W-24G-WW	24°	30u.	1u.
				RMS-CM-N-5W-36G-WW	36°	30u.	1u.
Doble 10W	9cm	700lm	Blanco Cálido 2700K	RMS-CMD-N-10W-15G-WW	15°	30u.	1u.
				RMS-CMD-N-10W-24G-WW	24°	30u.	1u.
				RMS-CMD-N-10W-36G-WW	36°	30u.	1u.
Simple 7W	14cm	370lm	Blanco Cálido 2700K	RMS-CM-N-7W-15G-WW	15°	30u.	1u.
				RMS-CM-N-7W-24G-WW	24°	30u.	1u.
				RMS-CM-N-7W-36G-WW	36°	30u.	1u.
Doble 14W	14cm	980lm	Blanco Cálido 2700K	RMS-CMD-N-14W-15G-WW	15°	30u.	1u.
				RMS-CMD-N-14W-24G-WW	24°	30u.	1u.
				RMS-CMD-N-14W-36G-WW	36°	30u.	1u.
Simple 12W	13cm	840lm	Blanco Cálido 2700K	RMS-CM-N-12W-15G-WW	15°	30u.	1u.
				RMS-CM-N-12W-24G-WW	24°	30u.	1u.
				RMS-CM-N-12W-36G-WW	36°	30u.	1u.
Simple 15W	17cm	1050lm	Blanco Cálido 2700K	RMS-CM-N-15W-15G-WW	15°	30u.	1u.
				RMS-CM-N-15W-24G-WW	24°	30u.	1u.
				RMS-CM-N-15W-36G-WW	36°	30u.	1u.

Spot Móvil

SMART

SKYLINE

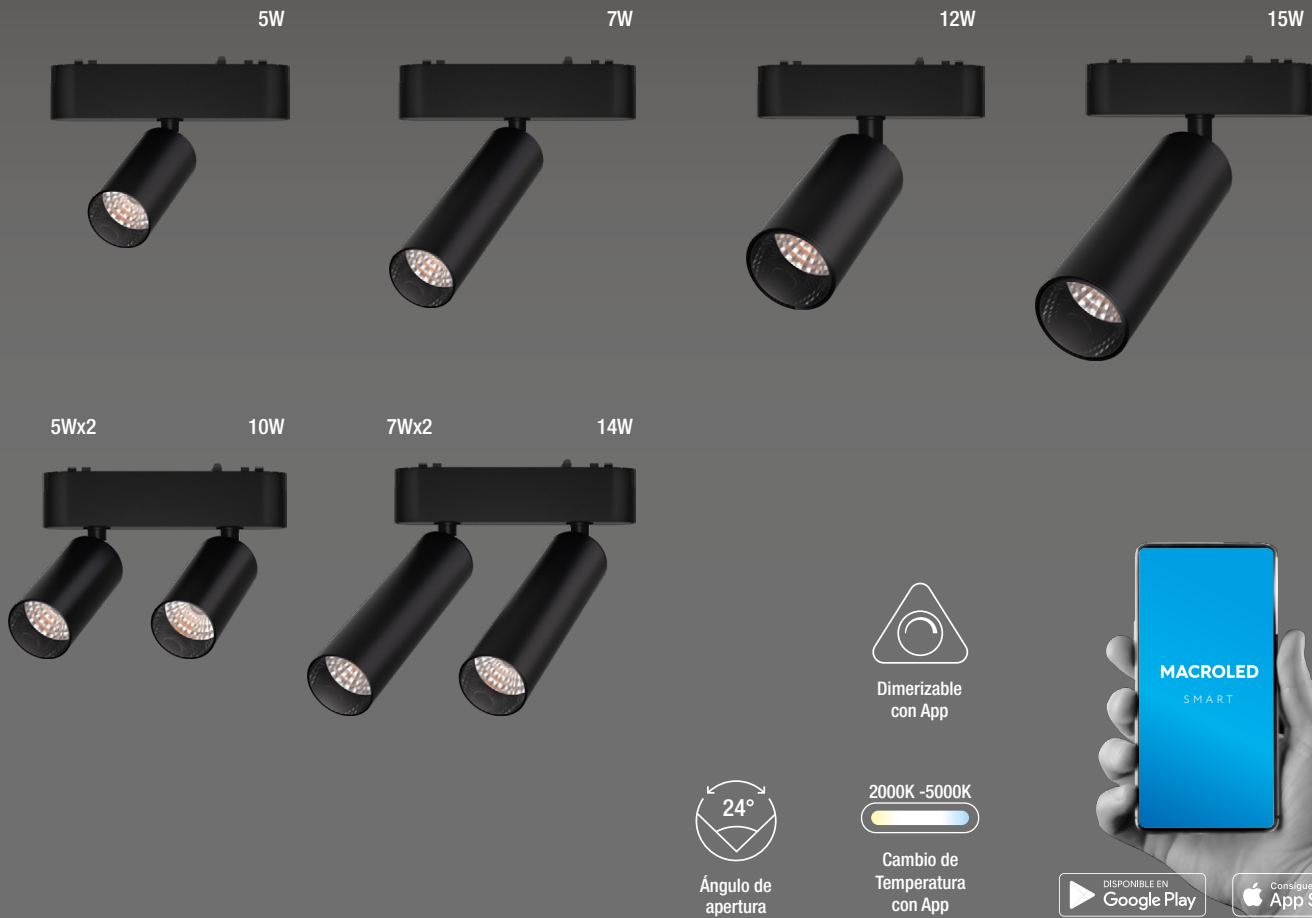

SPOT MÓVIL	LARGO	LÚMENES	TEMPCOLOR	MODELO	ÁNGULO	MASTER	VENTA MIN.
Simple 5W	9cm	275lm	2000K-5000K	RMS-S-CM-N-5W-24G	24°	30u.	1u.

SPOT MÓVIL	LARGO	LÚMENES	TEMPCOLOR	MODELO	ÁNGULO	MASTER	VENTA MIN.
Doble 10W	9cm	700lm	2000K-5000K	RMS-S-CMD-N-10W-24G	24°	30u.	1u.

SPOT MÓVIL	LARGO	LÚMENES	TEMPCOLOR	MODELO	ÁNGULO	MASTER	VENTA MIN.
Simple 7W	14cm	370lm	2000K-5000K	RMS-S-CM-N-7W-24G	24°	30u.	1u.

SPOT MÓVIL	LARGO	LÚMENES	TEMPCOLOR	MODELO	ÁNGULO	MASTER	VENTA MIN.
Doble 14W	14cm	980lm	2000K-5000K	RMS-S-CMD-N-14W-24G	24°	30u.	1u.

SPOT MÓVIL	LARGO	LÚMENES	TEMPCOLOR	MODELO	ÁNGULO	MASTER	VENTA MIN.
Simple 12W	13cm	840lm	2000K-5000K	RMS-S-CM-N-12W-24G	24°	30u.	1u.

SPOT MÓVIL	LARGO	LÚMENES	TEMPCOLOR	MODELO	ÁNGULO	MASTER	VENTA MIN.
Simple 15W	17cm	1050lm	2000K-5000K	RMS-S-CM-N-15W-24G	24°	30u.	1u.

Spot Móvil

SKYLINE



SPOT MÓVIL	LARGO	TEMPCOLOR	MODELO	ÁNGULO	MASTER	VENTA MIN.
Simple 5W	9cm	275lm	RMS-CM-B-5W-15G-WW	15°	30u.	1u.
			RMS-CM-B-5W-24G-WW	24°	30u.	1u.
			RMS-CM-B-5W-36G-WW	36°	30u.	1u.
Doble 10W	9cm	700lm	RMS-CMD-B-10W-15G-WW	15°	30u.	1u.
			RMS-CMD-B-10W-24G-WW	24°	30u.	1u.
			RMS-CMD-B-10W-36G-WW	36°	30u.	1u.
Simple 7W	14cm	370lm	RMS-CM-B-7W-15G-WW	15°	30u.	1u.
			RMS-CM-B-7W-24G-WW	24°	30u.	1u.
			RMS-CM-B-7W-36G-WW	36°	30u.	1u.
Doble 14W	14cm	980lm	RMS-CMD-B-14W-15G-WW	15°	30u.	1u.
			RMS-CMD-B-14W-24G-WW	24°	30u.	1u.
			RMS-CMD-B-14W-36G-WW	36°	30u.	1u.
Simple 12W	13cm	840lm	RMS-CM-B-12W-15G-WW	15°	30u.	1u.
			RMS-CM-B-12W-24G-WW	24°	30u.	1u.
			RMS-CM-B-12W-36G-WW	36°	30u.	1u.
Simple 15W	17cm	1050lm	RMS-CM-B-15W-15G-WW	15°	30u.	1u.
			RMS-CM-B-15W-24G-WW	24°	30u.	1u.
			RMS-CM-B-15W-36G-WW	36°	30u.	1u.

Spot Móvil

SMART

SKYLINE



SPOT MÓVIL	LARGO	LÚMENES	TEMPCOLOR	MODELO	ÁNGULO	MASTER	VENTA MIN.
Simple 5W	9cm	275lm	2000K-5000K	RMS-S-CM-B-5W-24G	24°	30u.	1u.
Doble 10W	9cm	700lm	2000K-5000K	RMS-S-CMD-B-10W-24G	24°	30u.	1u.
Simple 7W	14cm	370lm	2000K-5000K	RMS-S-CM-B-7W-24G	24°	30u.	1u.
Doble 14W	14cm	980lm	2000K-5000K	RMS-S-CMD-B-14W-24G	24°	30u.	1u.
Simple 12W	13cm	840lm	2000K-5000K	RMS-S-CM-B-12W-24G	24°	30u.	1u.
Simple 15W	17cm	1050lm	2000K-5000K	RMS-S-CM-B-15W-24G	24°	30u.	1u.

Colgante
TUBular

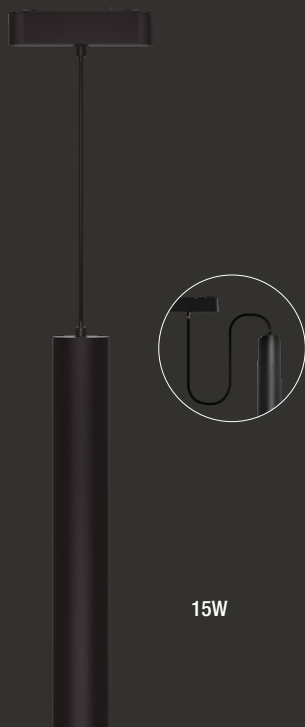

15W

Colgante Esférico
Difuso



10W

Colgante Esférico
Focal



12W

COLGANTE TUBULAR	TEMP.COLOR	LARGO	POTENCIA	LÚMENES	ÁNGULO	MASTER	VENTA MIN.
RMS-CC-N-9W-24G-WW	Blanco Cálido 2700K	100cm	9W	450lm	24°	20u.	1u.
RMS-CC-N-9W-36G-WW		100cm	9W	450lm	36°	20u.	1u.
RMS-CC-N-15W-15G-WW		100cm	15W	750lm	15°	30u.	1u.
RMS-CC-N-15W-24G-WW		100cm	15W	750lm	24°	30u.	1u.
RMS-CC-N-15W-36G-WW		100cm	15W	750lm	36°	30u.	1u.

COLGANTE ESFÉRICO DIFUSO	TEMP.COLOR	LARGO	POTENCIA	LÚMENES	ÁNGULO	MASTER	VENTA MIN.
RMS-CED-N-10W-WW	Cálido 2700K	100cm	10W	700lm	120°	20u.	1u.

APLIQUE ESFÉRICO DIFUSO	TEMP.COLOR	LARGO	POTENCIA	LÚMENES	ÁNGULO	MASTER	VENTA MIN.
RMS-AED-N-10W-WW	Cálido 2700K	11cm	10W	700lm	120°	20u.	1u.

COLGANTE ESFÉRICO FOCAL	TEMP.COLOR	LARGO	POTENCIA	LÚMENES	ÁNGULO	MASTER	VENTA MIN.
RMS-CEF-N-12W-WW	Cálido 2700K	100cm	12W	780lm	24°	20u.	1u.

APLIQUE ESFÉRICO FOCAL	TEMP.COLOR	LARGO	POTENCIA	LÚMENES	ÁNGULO	MASTER	VENTA MIN.
RMS-AEF-N-12W-24G-WW	Blanco Cálido 2700K	11cm	12W	780lm	24°	20u.	1u.
RMS-AEF-N-12W-36G-WW		11cm	12W	780lm	36°	20u.	1u.

Colgante Tubular

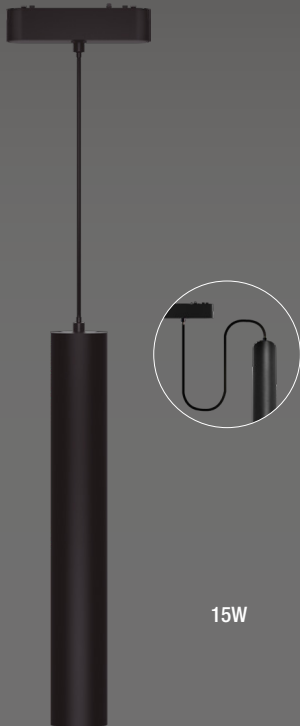

15W

Colgante Esférico Difuso



10W

Colgante Esférico Focal



12W



Dimerizable con App



Cambio de Temperatura con App



DISPONIBLE EN Google Play

Consíguelo en el App Store



COLGANTE TUBULAR		TEMP.COLOR	LARGO	POTENCIA	LÚMENES	ÁNGULO	MASTER	VENTA MIN.
RMS-S-CC-N-15W-24G	ø45mm	2000K-5000K	100cm	15W	750lm	24°	30u.	1u.
RMS-S-CC-N-15W-36G	ø45mm	2000K-5000K	100cm	15W	750lm	36°	30u.	1u.



COLGANTE ESFÉRICO DIFUSO		TEMP.COLOR	LARGO	POTENCIA	LÚMENES	ÁNGULO	MASTER	VENTA MIN.
RMS-S-CED-N-10W	ø100mm	2000K-5000K	100cm	10W	700lm	120°	20u.	1u.



APLIQUE ESFÉRICO DIFUSO		TEMP.COLOR	LARGO	POTENCIA	LÚMENES	ÁNGULO	MASTER	VENTA MIN.
RMS-S-AED-N-10W	ø100mm	2000K-5000K	11cm	10W	700lm	120°	20u.	1u.



COLGANTE ESFÉRICO FOCAL		TEMP.COLOR	LARGO	POTENCIA	LÚMENES	ÁNGULO	MASTER	VENTA MIN.
RMS-S-CEF-N-12W	ø100mm	2000K-5000K	100cm	12W	780lm	24°	20u.	1u.



APLIQUE ESFÉRICO FOCAL		TEMP.COLOR	LARGO	POTENCIA	LÚMENES	ÁNGULO	MASTER	VENTA MIN.
RMS-S-AEF-N-12W-24G	ø100mm	2000K-5000K	11cm	12W	780lm	24°	20u.	1u.

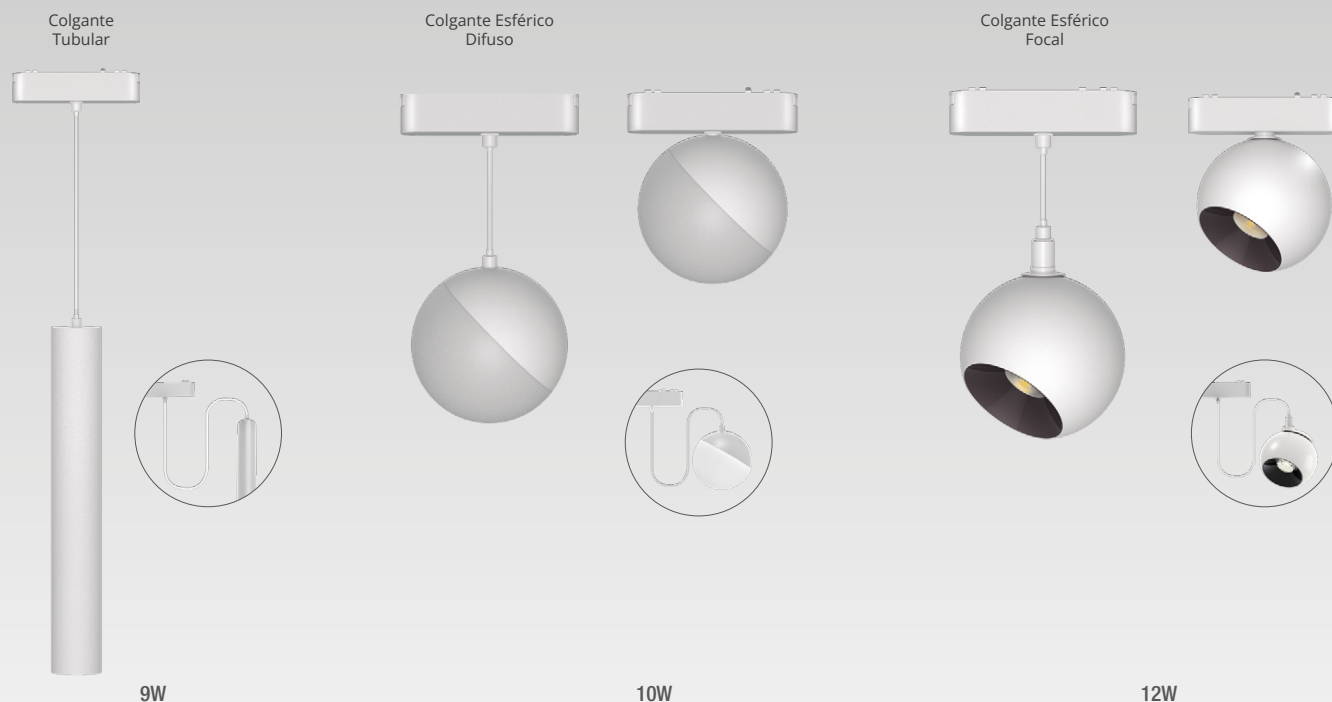

COLGANTE TUBULAR	TEMP.COLOR	LARGO	POTENCIA	LÚMENES	ÁNGULO	MASTER	VENTA MIN.
RMS-CC-B-9W-24G-WW	Blanco Cálido 2700K	100cm	9W	450lm	24°	20u.	1u.
RMS-CC-B-9W-36G-WW		100cm	9W	450lm	36°	20u.	1u.
RMS-CC-B-15W-15G-WW		100cm	15W	750lm	15°	30u.	1u.
RMS-CC-B-15W-24G-WW		100cm	15W	750lm	24°	30u.	1u.
RMS-CC-B-15W-36G-WW		100cm	15W	750lm	36°	30u.	1u.

COLGANTE ESFÉRICO DIFUSO	TEMP.COLOR	LARGO	POTENCIA	LÚMENES	ÁNGULO	MASTER	VENTA MIN.
RMS-CED-B-10W-WW	Cálido 2700K	100cm	10W	700lm	120°	20u.	1u.

APLIQUE ESFÉRICO DIFUSO	TEMP.COLOR	LARGO	POTENCIA	LÚMENES	ÁNGULO	MASTER	VENTA MIN.
RMS-AED-B-10W-WW	Cálido 2700K	11cm	10W	700lm	120°	20u.	1u.

APLIQUE ESFÉRICO FOCAL	TEMP.COLOR	LARGO	POTENCIA	LÚMENES	ÁNGULO	MASTER	VENTA MIN.
RMS-CEF-B-12W-WW	Cálido 2700K	100cm	12W	780lm	24°	20u.	1u.

APLIQUE ESFÉRICO FOCAL	TEMP.COLOR	LARGO	POTENCIA	LÚMENES	ÁNGULO	MASTER	VENTA MIN.
RMS-AEF-B-12W-24G-WW	Blanco Cálido 2700K	11cm	12W	780lm	24°	20u.	1u.
RMS-AEF-B-12W-36G-WW		11cm	12W	780lm	24°	20u.	1u.

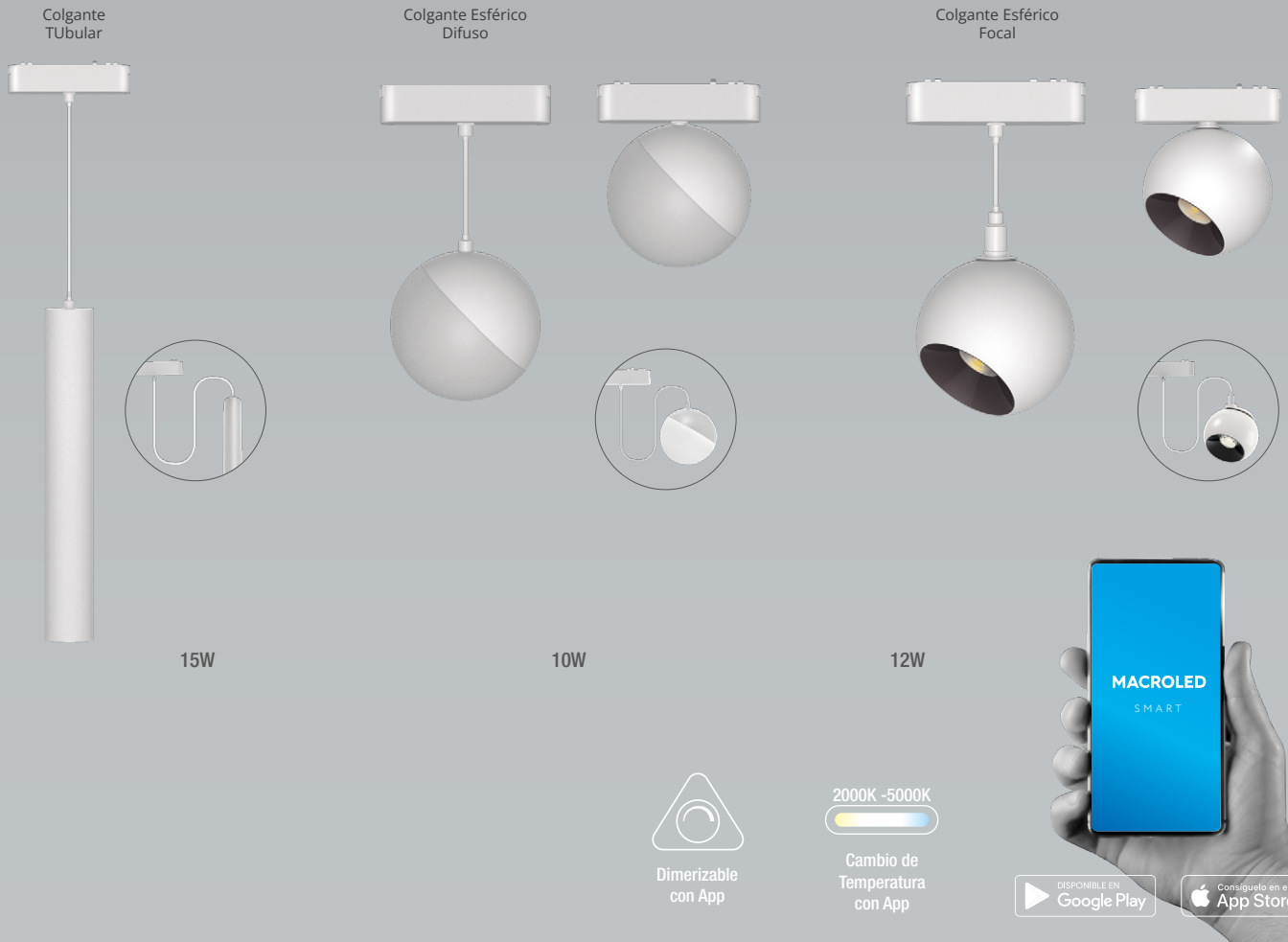

COLGANTE TUBULAR		TEMP.COLOR	LARGO	POTENCIA	LÚMENES	ÁNGULO	MASTER	VENTA MIN.
RMS-S-CC-B-15W-24G	ø45mm	2000K-5000K	100cm	15W	750lm	24°	30u.	1u.
RMS-S-CC-B-15W-36G	ø45mm	2000K-5000K	100cm	15W	750lm	36°	30u.	1u.
COLGANTE ESFÉRICO DIFUSO		TEMP.COLOR	LARGO	POTENCIA	LÚMENES	MASTER	VENTA MIN.	
RMS-S-CED-B-10W	ø100mm	2000K-5000K	100cm	10W	700lm		20u.	1u.
APLIQUE ESFÉRICO DIFUSO		TEMP.COLOR	LARGO	POTENCIA	LÚMENES	MASTER	VENTA MIN.	
RMS-S-AED-B-10W	ø100mm	2000K-5000K	11cm	10W	700lm		20u.	1u.
COLGANTE ESFÉRICO FOCAL		TEMP.COLOR	LARGO	POTENCIA	LÚMENES	MASTER	VENTA MIN.	
RMS-S-CEF-B-12W	ø100mm	2000K-5000K	100cm	12W	780lm		20u.	1u.
APLIQUE ESFÉRICO FOCAL		TEMP.COLOR	LARGO	POTENCIA	LÚMENES	MASTER	VENTA MIN.	
RMS-S-AEF-B-12W-24G	ø100mm	2000K-5000K	11cm	12W	780lm		20u.	1u.

APLIQUE TUBO DIFUSO
30cm



Colgante
Tubo flexible



APLIQUE TUBO DIFUSO
60cm

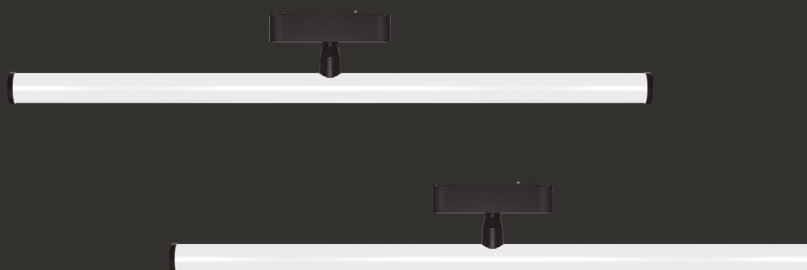

APLIQUE TUBO DIFUSO / NEGRO		TEMP.COLOR	LARGO	POTENCIA	LÚMENES	MASTER	VENTA MIN.
RMS-ATD302-N-6W-WW	ø28mm	Blanco	30cm	6W	600lm	20u.	1u.
RMS-ATD602-N-12W-WW	ø28mm	Cálido 2700K	60cm	12W	1500lm	20u.	1u.

APLIQUE TUBO DIFUSO / BLANCO		TEMP.COLOR	LARGO	POTENCIA	LÚMENES	MASTER	VENTA MIN.
RMS-ATD302-B-6W-WW	ø28mm	Blanco	30cm	6W	600lm	20u.	1u.
RMS-ATD602-B-12W-WW	ø28mm	Cálido 2700K	60cm	12W	1500lm	20u.	1u.

TUBO FLEXIBLE DIFUSO / NEGRO		TEMP.COLOR	LARGO	POTENCIA	LÚMENES	MASTER	VENTA MIN.
RMS-TF1000-N-10W-WW	ø22mm	Blanco	100cm	10W	600lm	10u.	1u.
RMS-TF2000-N-20W-WW	ø22mm	Cálido 2700K	200cm	20W	1500lm	10u.	1u.

TUBO FLEXIBLE DIFUSO / BLANCO		TEMP.COLOR	LARGO	POTENCIA	LÚMENES	MASTER	VENTA MIN.
RMS-TF1000-B-10W-WW	ø22mm	Blanco	100cm	10W	600lm	10u.	1u.
RMS-TF2000-B-20W-WW	ø22mm	Cálido 2700K	200cm	20W	1500lm	10u.	1u.

Fuente de Alimentación

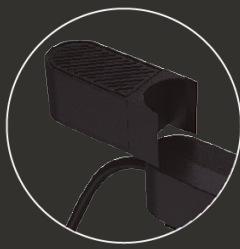
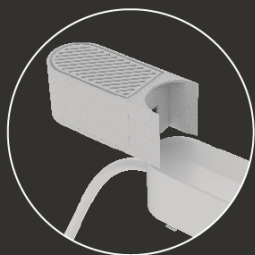

Incluyen endcaps cubrecable



100W-48V

200W-48V



AC185-265V

FUENTE DE ALIMENTACIÓN	COLOR	MEDIDAS	POTENCIA	CORRIENTE	DIMERIZABLE	MASTER	VENTA MIN.
FRMS-100W-48V-NEG	Negro	290x25x27mm	100W	2.1A	No	50u.	50u.
FRMS-200W-48V-NEG	Negro	340x25x27mm	200W	4.2A	No	50u.	50u.
FRMS-100W-48V-BCO	Blanco	290x25x27mm	100W	2.1A	No	50u.	50u.
FRMS-200W-48V-BCO	Blanco	340x25x27mm	200W	4.2A	No	50u.	50u.
FRMS-DIM-100W-48V-NEG	Negro	290x25x27mm	100W	2.1A	Si	50u.	50u.
FRMS-DIM-200W-48V-NEG	Negro	340x25x27mm	200W	4.2A	Si	50u.	50u.
FRMS-DIM-100W-48V-BCO	Blanco	290x25x27mm	100W	2.1A	Si	50u.	50u.
FRMS-DIM-200W-48V-BCO	Blanco	340x25x27mm	200W	4.2A	Si	50u.	50u.

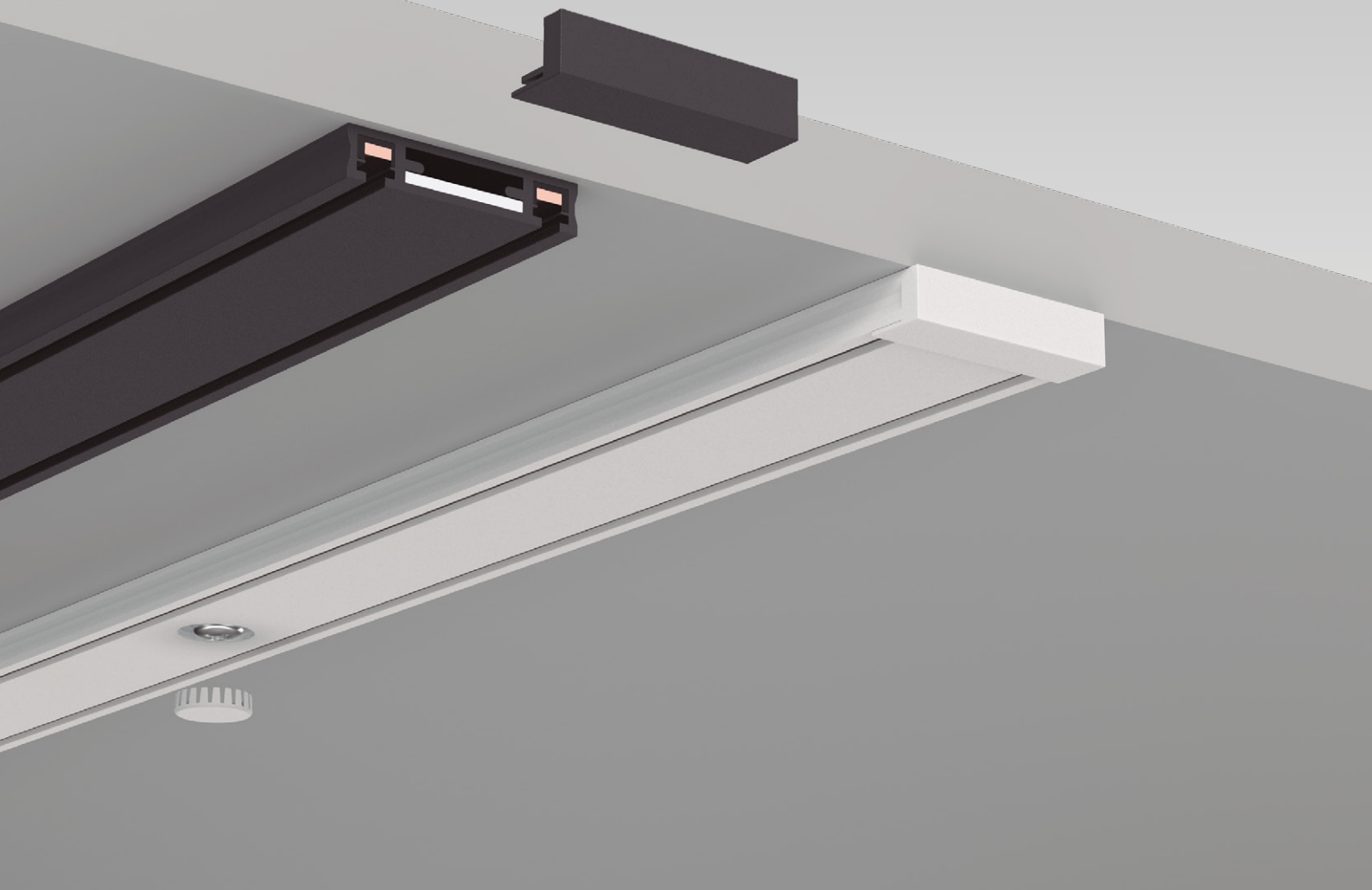

RIELES SLIM	COLOR	METROS	DESCRIPCIÓN	MASTER	INTERMEDIA	VENTA MIN.
RMS-1M-B	● Blanco	1	Riel Magnético Skyline Macroled, DC48V C/ Endcap	40u.	4u.	4u.
RMS-1M-N	● Negro			40u.	4u.	4u.
RMS-2M-BCO	● Blanco	2	Riel Magnético Skyline Macroled, DC48V C/ Endcap	40u.	4u.	4u.
RMS-2M-NEG	● Negro			40u.	4u.	4u.
RMS-3M-BCO	● Blanco	3	Riel Magnético Skyline Macroled, DC48V C/ Endcap	40u.	4u.	4u.
RMS-3M-NEG	● Negro			40u.	4u.	4u.

ACCESORIOS	COLOR	DESCRIPCIÓN	MASTER	INTERMEDIA	VENTA MIN.
RMS-CLR-B	● Blanco	 L Recto	100u.	20u.	2u.
RMS-CLR-N	● Negro	 L Recto	100u.	20u.	2u.
RMS-CLC-B	● Blanco	 L Curvo	100u.	20u.	2u.
RMS-CLC-N	● Negro	 L Curvo	100u.	20u.	2u.
RMS-CT-B	● Blanco	 T Recto	100u.	50u.	2u.
RMS-CT-N	● Negro	 T Recto	100u.	50u.	2u.
RMS-CX-B	● Blanco	 X Curvo	100u.	50u.	2u.
RMS-CX-N	● Negro	 X Curvo	100u.	50u.	2u.
RMS-CLV-B	● Blanco	 L Vertical	100u.	20u.	2u.
RMS-CLV-N	● Negro	 L Vertical	100u.	20u.	2u.
RMS-CPR-B	● Blanco	 Prolongador Recto	200u.	20u.	4u.
RMS-CPR-N	● Negro	 Prolongador Recto	200u.	20u.	4u.

Riel Embutir

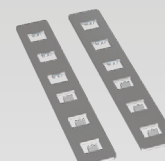
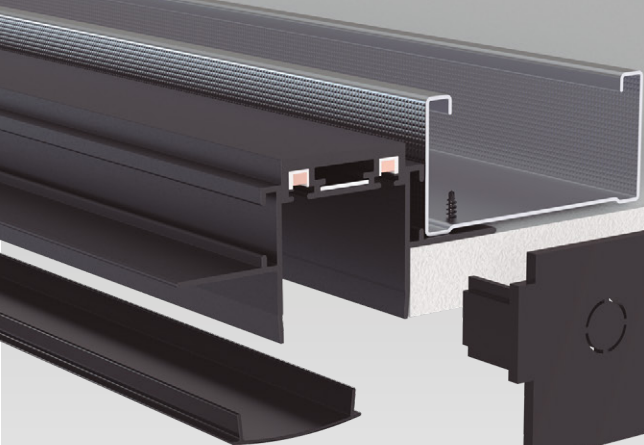

Acoplador de rieles

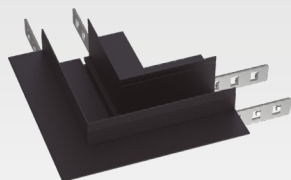

Acople Físico
L



Acople Físico
L vertical

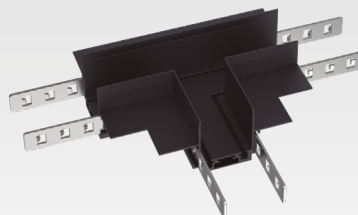

Acople Físico
T

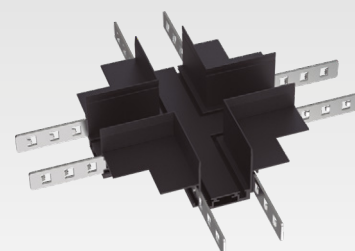

Acople Físico
x



Conductor Elctrico
I



Conductor Elctrico
L







Conductor Elctrico
T



Conductor Elctrico
X



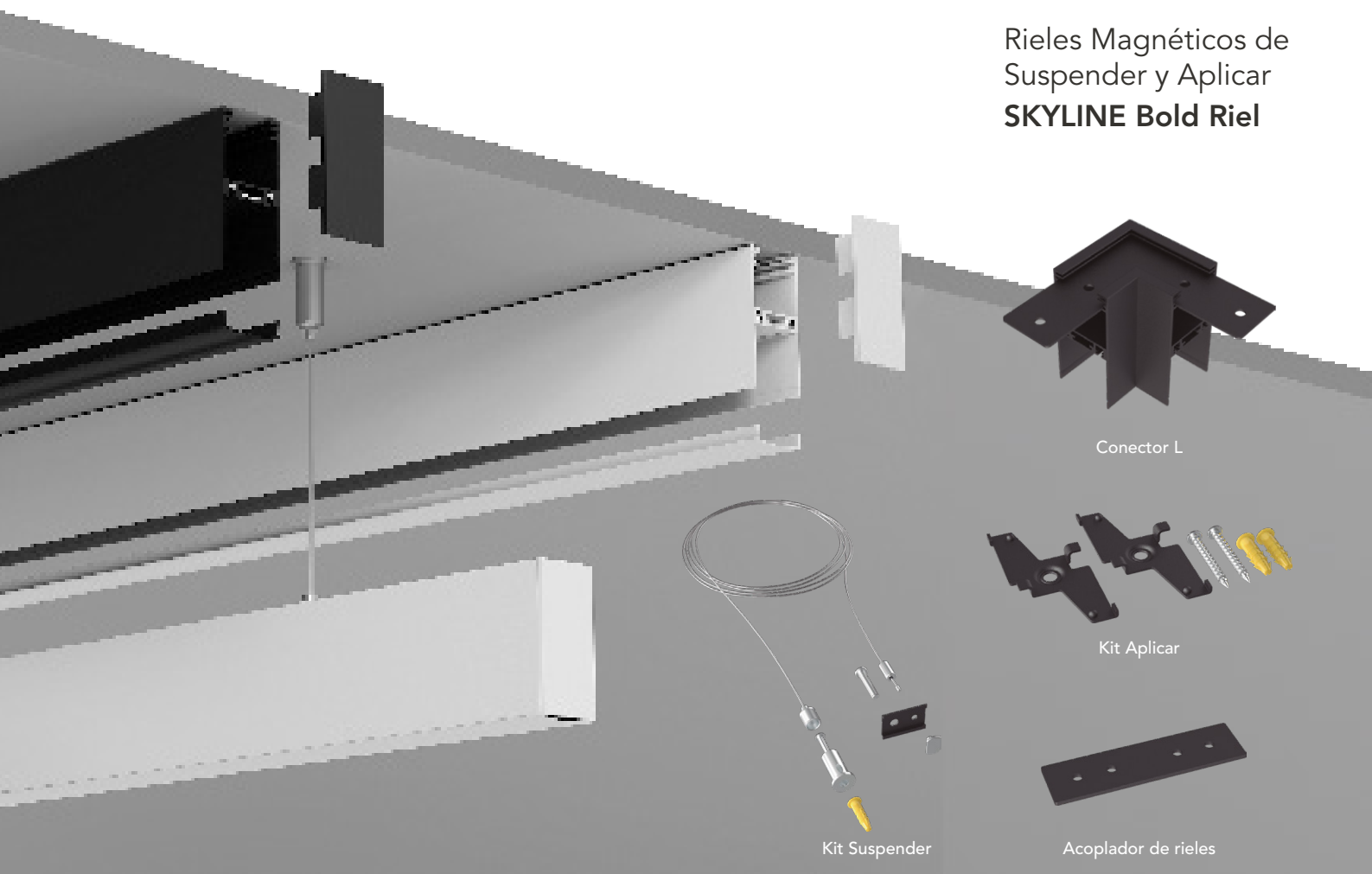

RIELES EMBUTIR	DESCRIPCIÓN	MASTER	INTERMEDIA	VENTA MIN.
RMS-E-1M	 Riel de aluminio para embutir Skyline 1m, DC48V	10u.	-	10u.
RMS-E-2M	 Riel de aluminio para embutir Skyline 2m, DC48V	10u.	-	10u.
RMS-E-3M	 Riel de aluminio para embutir Skyline 3m, DC48V	10u.	-	10u.
RMS-AR-E	 Acoplador de para riel magnético Skyline de embutir	800u.	100u.	1u.
RMS-CL-E	 Conector tipo L para riel magnético Skyline de embutir	50u.	-	1u.
RMS-CT-E	 Conector tipo T para riel magnético Skyline de embutir	50u.	-	1u.
RMS-CX-E	 Conector tipo X para riel magnético Skyline de embutir	50u.	-	1u.
RMS-CLV-E	 Conector tipo L vertical para riel magnético Skyline de embutir	50u.	-	1u.

SUSPENDER / EMBUTIR	DESCRIPCIÓN	MASTER	VENTA MIN.
RMS-ELI-E-S	 Extensor de línea tipo I para riel magnético Skyline de embutir o suspensión DC48V	100u.	1u.
RMS-ETLL-E-S	 Extensor de línea tipo L para riel magnético Skyline de embutir o suspensión DC48V	100u.	1u.
RMS-ETLT-E-S	 Extensor de línea tipo T para riel magnético Skyline de embutir o suspensión DC48V	100u.	1u.
RMS-ETLX-E-S	 Extensor de línea tipo X para riel magnético Skyline de embutir o suspensión DC48V	100u.	1u.

Rieles Magnéticos de Suspender y Aplicar SKYLINE Bold Riel



RIELES BOLD	DESCRIPCIÓN	MASTER	INTERMEDIA	VENTA MIN.
RMS-S-1M-B	 Riel de aluminio Bold Skyline Blanco 1m, DC48V	5u.	-	5u.
RMS-S-2M-B	Riel de aluminio Bold Skyline Blanco 2m, DC48V	5u.	-	5u.
RMS-S-3M-B	Riel de aluminio Bold Skyline Blanco 3m, DC48V	5u.	-	5u.
RMS-S-1M	 Riel de aluminio Bold Skyline Negro 1m, DC48V	5u.	-	5u.
RMS-S-2M	Riel de aluminio Bold Skyline Negro 2m, DC48V	5u.	-	5u.
RMS-S-3M	Riel de aluminio Bold Skyline Negro 3m, DC48V	5u.	-	5u.
RMS-AR-S	 Acoplador de rieles para riel magnético Bold Skyline	400u.	50u.	1u.
RMS-CL-S	 Conector tipo L para riel magnético Bold Skyline	50u.	-	1u.
RMS-S-S	 Suspensor de rieles para riel magnético Bold Skyline 2x2 metros	100u.	-	Unitaria (x2 u.)
RMS-A-S	 Kit Aplicar para riel magnético Bold Skyline	100u.	-	10u.

BOLD / EMBUTIR	DESCRIPCIÓN	MASTER	INTERMEDIA	VENTA MIN.
RMS-ELI-E-S	 Extensor de línea tipo I para riel magnético Bold o embutir Skyline DC48V	100u.	10u.	1u.
RMS-ETLL-E-S	 Extensor de línea tipo L para riel magnético Bold o embutir Skyline DC48V	100u.	10u.	1u.
RMS-ETLT-E-S	 Extensor de línea tipo T para riel magnético Bold o embutir Skyline DC48V	100u.	10u.	1u.
RMS-ETLX-E-S	 Extensor de línea tipo X para riel magnético Bold o embutir Skyline DC48V	100u.	10u.	1u.

Derecho de Imagen y Representación

Todo el contenido visual (imágenes, fotografías, logotipos, etc.) de nuestras marcas Macroled, PowerSwitch e Inteck y por consiguiente de la marca CHINT y Astronergy donde actuamos como representante oficial en el país son propiedad intelectual pertenecientes a Coresa Group SRL, queda terminantemente prohibido el uso inadecuado o la reproducción de contenido sin autorización escrita por parte de la empresa. En caso de poseer dicha autorización, el contenido visual utilizado deberá estar acompañado por nuestra marca madre Coresa Group y/o por la siguiente descripción: "Propiedad Intelectual de Coresa Group SRL todos los derechos Reservados". O una marca del grupo Coresa.

CUENTA BANCARIA

Titular: Coresa Group SRL

CUIT: 30-71178446-9



CBU: 0720762620000002861618

Cuenta Cte: 762-028616/1

Sucursal: Pellegrini (018/6)

GERENCIA COMERCIAL

Dirección: Laminar Plaza: Ingeniero Butty 240, piso 10.

Tel: 0810-222-2882

Interno ---

GERENTE LOGÍSTICO

Contacto: Santiago Osorio

0810 222 2882

Interno 103

santiago.osorio@coresagroup.com.ar

Centro Logístico 3 de Febrero - Grupo Posadas. Km 10, Au Cam. del Buen Ayre, 1678 Buenos Aires

HORARIOS DE ATENCIÓN Lunes a Viernes de 9:00 a 18:00 hs

DESCUENTO	TODA LA LISTA	MACROLED	RESTO	CHINT	UNIVIEW
 % % % % %
Forma de pago	LC=US0 : LC + LCC				
Envios sin cargo desde: USD.				
Facturación \$ (TIPO DE CAMBIO BNA - BANCO NACIÓN ARGENTINA)					
Garantías: Macroled General 2 años, Macroled Alta Potencia 5 años, PowerSwitch 2 años CHINT 3 años, CHINT Power 5 años, Astronergy 10 Años MACROLED, 1, 2, LÍNEA PRO 3 O LÍNEA ALTA POTENCIA 5 AÑOS, CHINT 3 AÑOS, UNV 1, 2 AÑOS					
Capacitaciones Técnicas y Comerciales.				
Acciones de Marketing en punto de Venta.				
Observaciones.				